

Finite Energy Foliations and Surgery on Transverse Links*

by

Chris Wendl

A dissertation submitted in partial fulfillment

of the requirements for the degree of

Doctor of Philosophy

Department of Mathematics

New York University

January 2005

Helmut Hofer—Advisor

*Revised version: July 14, 2005

© Chris Wendl
All Rights Reserved, 2005

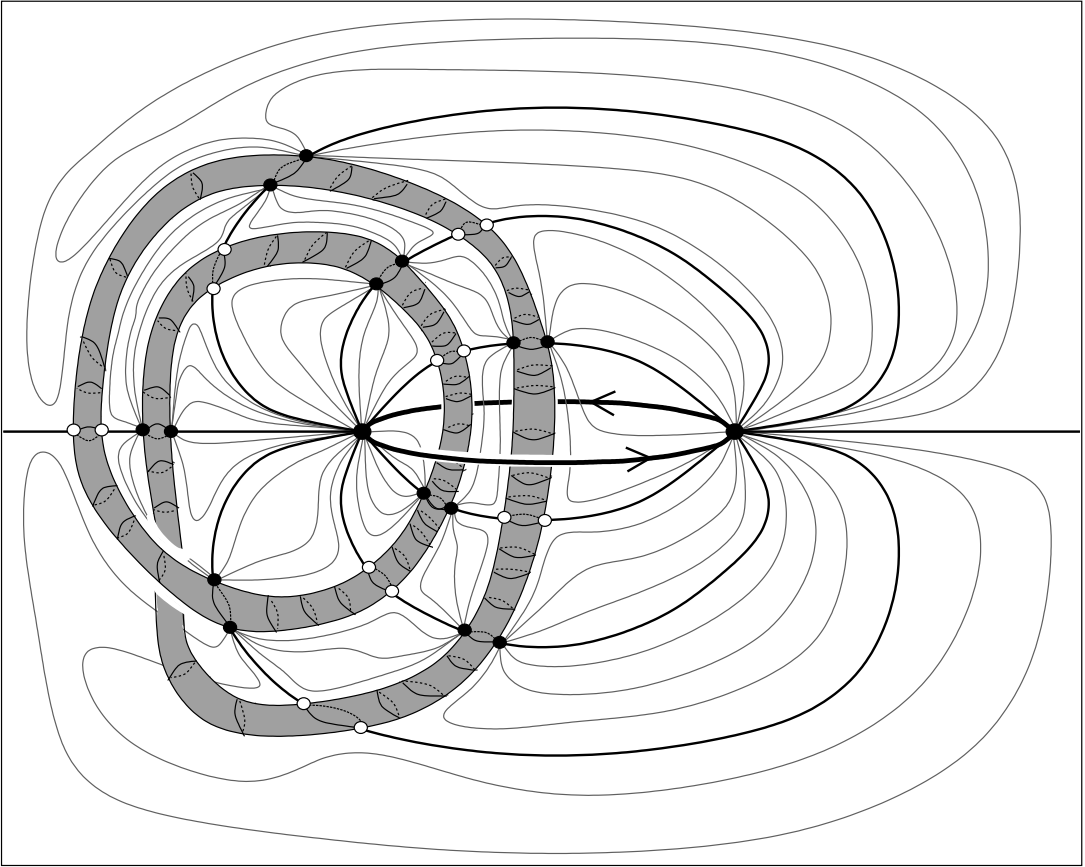

To my parents, who had the good sense not to pressure me into studying something practical.

Acknowledgments

I must first thank my advisor, Helmut Hofer, whose contagious enthusiasm for symplectic geometry drew me in long before I had any real idea what I was getting into. His intuition and sharp intellect are a tremendous inspiration, and his all around pleasant disposition doesn't hurt either.

I've benefitted greatly from the tight-knit community of students that have constituted Courant's symplectic group in the last few years, notably Barney Bramham, Joel Fish, Sunil Pinnamaneni, Sam Lisi, Breno Madero and Richard Siefring. I'm especially indebted to Richard for many helpful discussions about intersection theory and his own piece of the foliation program. Thanks also to Joe Coffey, for suggesting quite rightly that I turn to Google in a moment of desperation.

Incidentally, many of the best (and worst) ideas in this thesis were hatched in various independent Brooklyn coffeehouses, of which "Tillie's" of Fort Greene and Park Slope's "Tea Lounge" deserve special mention. Hopefully, the caffeine level is not reflected in the prose.

Abstract

Pseudoholomorphic curves have become an essential tool in symplectic topology since their introduction by Gromov in 1985. They have also found application in contact topology, where the existence of punctured holomorphic curves is closely related to the dynamics of Reeb vector fields, and can be used to define contact invariants via symplectic field theory.

Punctured holomorphic curves have particularly nice properties in contact three-manifolds and their four-dimensional symplectizations, where intersections and transversality can be controlled algebraically. This leads to the existence of two-dimensional foliations by embedded holomorphic curves in the symplectization, which project onto the contact manifold as one-dimensional singular foliations transverse to the Reeb orbits. The existence of such foliations has been established previously for generic tight three-spheres by Hofer, Wysocki and Zehnder, with powerful consequences for the Reeb dynamics.

The present thesis aims at extending this existence result to more general three-manifolds and contact structures. To accomplish this, we develop a method for preserving families of holomorphic curves under surgery along knots which cut transversely through both the contact structure and the holomorphic curves. This is done by considering a mixed boundary value problem on punctured Riemann surfaces with boundary, then using the compactness properties of holomorphic curves to degenerate each boundary component to a puncture. The result is that a holomorphic foliation on the tight three-sphere can be used to construct a similar foliation for every closed three-manifold with any overtwisted contact structure. This is the first step in a program suggested by Hofer to prove the Weinstein conjecture in dimension three by constructing foliations or related objects for generic contact manifolds. The constructions here also lead to some concrete examples of an algebraic theory in the spirit of Floer homology and symplectic field theory, which is conjectured to be of fundamental significance in the theory of holomorphic foliations, and may turn out to have broader applications in three-dimensional topology.

Contents

Dedication	v
Acknowledgments	vi
Abstract	vii
List of Figures	xi
1 Introduction	1
1.1 Holomorphic curves in contact geometry	1
1.2 Finite energy foliations	7
1.3 Main result: Morse-Bott foliations in the overtwisted case	14
1.4 Outline of the proof	16
1.5 Toward a homotopy theory of finite energy foliations	21
2 Contact Structures and Transverse Surgery	25
2.1 The theorem of Martinet and Lutz	25
2.2 Transverse links are almost Hopf circles	31
3 Explicit Constructions of Foliations	34
3.1 Morse-Bott contact structures in $S^1 \times \mathbb{R}^2$	35
3.2 Local modifications and continuation	45
3.3 Nondegenerate perturbations	50
4 Holomorphic Curves with Boundary and Interior Punctures	59
4.1 Mixed boundary conditions and Problem (BP)	59
4.2 The Maslov index	62
4.2.1 Maslov and Conley-Zehnder indices	62
4.2.2 Bundles with boundary data	63
4.2.3 Morse-Bott asymptotics	74

4.3	Estimating $\text{wind}_\pi(\tilde{u})$	76
4.4	Intersections	87
4.4.1	Somewhere injective curves	88
4.4.2	Excluding intersections in M	90
4.5	Fredholm theory	95
4.5.1	Problem (BP') and special coordinates	96
4.5.2	Functional analytic setup	103
4.5.3	Linearization	112
4.5.4	Index formula	119
4.5.5	Automatic transversality results	124
4.5.6	Implicit function theorem	132
4.5.7	Parametrized deformations	135
4.6	Energy	142
4.6.1	Taming functions and asymptotics	142
4.6.2	Pseudo-Lagrangian tori and energy bounds	155
4.6.3	Removing punctures on the boundary	158
4.6.4	Localization at the punctures	163
5	Modifying Foliations under Surgery	173
5.1	The main construction	173
5.1.1	Planar open books in the tight three-sphere	173
5.1.2	Simplifying the contact form near a link	175
5.1.3	An open book decomposition with boundary	182
5.1.4	Twisting the contact structure	187
5.1.5	The proof for general closed braids	193
5.2	Compactness by linking arguments	198
5.2.1	Gradient bounds	201
5.2.2	Convergence of conformal structures	213
5.3	Noncompactness: boundary \rightarrow puncture	223
6	Sketch of a Floer-Type Theory for Foliations	232
6.1	Algebraization	232
6.2	Functoriality	236
6.3	Computations of foliation contact homology	238
6.3.1	The tight 3-sphere	238
6.3.2	Overtwisted contact structures	240
6.3.3	$S^1 \times S^2$	241

A	Asymptotics of Finite Energy Surfaces	245
A.1	Asymptotic operators	245
A.2	Exponential approach	250
A.3	A criterion for finite energy	251
B	Deligne-Mumford For Surfaces with Boundary	254
B.1	Nodal surfaces	254
B.2	Symmetric nodal surfaces and boundaries	257
	Bibliography	263

List of Figures

1.1	Finite energy torus with three punctures	5
1.2	Local foliation by finite energy planes	8
1.3	Planar open book decomposition of S^3	11
1.4	Stable finite energy foliation of S^3	12
1.5	Morse-Bott foliation of overtwisted S^3	18
1.6	Nondegenerate perturbed foliation of overtwisted S^3	19
2.1	The standard contact structure as a trajectory in \mathbb{R}^2	29
2.2	The standard contact structure after Dehn surgery	29
2.3	Half-Lutz twist	29
2.4	Full-Lutz twist	29
3.1	Finite energy cylinders spanning concentric Morse-Bott tori	39
3.2	Finite energy planes and cylinders inside a Morse-Bott torus	43
3.3	Holomorphic cylinder of type (p, q)	44
3.4	Cylinder of type (p, q) with $\rho_- = 0$	44
3.5	Integral curves for constructing a nondegenerate foliation	54
3.6	Foliations of T^3	57
3.7	Foliation of $S^1 \times S^2$	58
3.8	More foliations of $S^1 \times S^2$	58
4.1	The partition $S = S_\epsilon \cup A_\epsilon$	79
5.1	Smooth family of reparametrizations	189
5.2	Twisting the contact form on a torus	190
5.3	A closed braid with one component and its 3-fold cover	195
5.4	Topological obstructions to bubbling off	199
5.5	Bubbling off tree for holomorphic planes with boundary	202
5.6	Piecewise smooth circles in $\overline{\mathbf{S}}_r$	218
5.7	Perturbed circles in $\varphi_k(\overline{\mathbf{S}}_r)$	220

6.1	Stable foliation \mathcal{F}_1 : tight S^3 , with coherent orientations	239
6.2	Stable foliation \mathcal{F}_0 : an open book decomposition of tight S^3	240
6.3	Foliation near a full-Lutz twist	241
6.4	Foliation \mathcal{F}_2 on $S^1 \times S^2$	242
6.5	Foliations \mathcal{F}_3 and \mathcal{F}_4 on $S^1 \times S^2$	243
B.1	Compactification with circles and arcs at infinity	260
B.2	Degeneration of a stable Riemann surface with boundary	262

Chapter 1

Introduction

1.1 Holomorphic curves in contact geometry

In general, a *pseudoholomorphic curve* is a map $u : S \rightarrow W$ from a Riemann surface (S, j) to a $2n$ -dimensional almost complex manifold (W, J) satisfying

$$Tu \circ j = J \circ Tu. \tag{1.1.1}$$

The *almost complex structure* $J : TW \rightarrow TW$ is, by definition, a smooth fiberwise linear map satisfying $J^2 = -\text{Id}$. We call J *integrable* if it is induced by a family of charts identifying (W, J) locally with (\mathbb{C}^n, i) , i.e. W is a complex manifold. In this case (1.1.1) is locally equivalent to the standard Cauchy-Riemann equations, so its solutions are holomorphic maps. In general though, J need not be integrable except for $n = 1$, and the study of Equation (1.1.1) falls into the realm of elliptic PDE theory rather than complex analysis. As such, the solution spaces can be analyzed in a very elegant way via nonlinear functional analysis and Fredholm theory. The solutions $u : S \rightarrow W$ are also called *J-holomorphic curves*, or abbreviated as “holomorphic” when there’s no ambiguity.

Gromov discovered in his seminal paper [Gr85] that *J-holomorphic curves* provide a natural tool for the study of symplectic manifolds. In this setting, one chooses almost complex structures J that are *tamed* by the symplectic form ω , meaning

$$\omega(X, JX) > 0 \quad \text{for all } X \in TW, X \neq 0.$$

It’s often convenient to strengthen this condition slightly: J is called *compatible* with ω if the bilinear form

$$g_J = \omega(\cdot, J\cdot)$$

defines a Riemannian metric. The spaces of almost complex structures that are tamed by or compatible with a given symplectic form are always nonempty and

contractible, and the particular choice of J is seldom of much importance for any application. The advantage of the taming condition is that one can then bound the area of a closed holomorphic curve in terms of purely topological quantities; this establishes uniform area bounds for the solution spaces, leading to compactness results. Gromov used these properties to prove several startling results in symplectic topology, notably his celebrated “non-squeezing” theorem.

In the late 1980’s, holomorphic curves on noncompact domains were introduced by Floer [F88], in his novel approach to infinite-dimensional Morse theory and the Arnold conjecture. In the noncompact case, it is vital to have a notion of “finite energy,” which establishes some control over the asymptotic behavior of a holomorphic curve. In Hamiltonian Floer homology, for example, one considers cylinders $u : \mathbb{R} \times S^1 \rightarrow W$ that satisfy a version of (1.1.1) which is related to a given Hamiltonian system. Then it turns out that solutions with finite energy always approach periodic orbits of the Hamiltonian vector field at each end of the cylinder.

In what follows, we will be concerned largely with an analogous construction in contact geometry. Let M be a smooth manifold of dimension $2n + 1$, with $n \geq 1$. A *contact form* on M is a smooth 1-form λ with the property that

$$\lambda \wedge (d\lambda)^n \tag{1.1.2}$$

is a volume form. Then the $2n$ -plane distribution $\xi = \ker \lambda$ is called a *contact structure*, and the contact condition (1.1.2) guarantees that ξ is, in some sense, “maximally non-integrable”. In particular, an integral submanifold $L \subset M$ of ξ (called a *Legendrian* submanifold) never has dimension greater than n . On the other hand, there are plenty of n -dimensional Legendrian submanifolds; this follows easily from *Darboux’s theorem*, which states, as in the symplectic case, that all contact manifolds are locally equivalent. In particular, every point has a neighborhood with coordinates $(x_1, y_1, \dots, x_n, y_n, z)$ in which λ takes the canonical form

$$\lambda = dz + \sum_{j=1}^n x_j dy_j.$$

If M is given an orientation, then the contact form is called *positive* if the volume form $\lambda \wedge (d\lambda)^n$ has positive sign. Note that, given any smooth positive function $f : M \rightarrow \mathbb{R}$, λ is positive if and only if $f\lambda$ is also, thus it makes sense to speak of *positive contact structures*, without direct reference to a contact form. It should also be noted that a contact structure can exist without a global contact form; the contact condition only requires the local existence of a 1-form satisfying (1.1.2). Contact forms do exist globally for any contact structure that is *coorientable*, i.e. the quotient TM/ξ is orientable. We will work exclusively with contact structures that are both positive and coorientable.

A *contact manifold* is usually defined to be the pair (M, ξ) , where ξ is a contact structure, and the isomorphisms $(M, \xi) \cong (M', \xi')$ in this category are defined by *contactomorphisms*, i.e. diffeomorphisms $\varphi : M \rightarrow M'$ that satisfy $\varphi_*\xi = \xi'$. Contact topology is thus considered to be the study of the category of manifolds with contact structures. Alternatively, one can work more directly with contact *forms* and call the pair (M, λ) a contact manifold, with contactomorphisms required to satisfy $\varphi^*\lambda' = \lambda$. This definition will be more convenient for our purposes, though we'll use both concepts interchangeably when there is no ambiguity.

There is an important dynamical system associated with every contact form. Given (M, λ) , the *Reeb vector field* X_λ is uniquely defined by the conditions

$$d\lambda(X_\lambda, \cdot) \equiv 0 \quad \text{and} \quad \lambda(X_\lambda) \equiv 1. \quad (1.1.3)$$

The existence of closed orbits for X_λ is a fundamental open question in contact geometry.

Conjecture 1.1.1 (Weinstein). *Every closed contact manifold (M, λ) admits a closed orbit of X_λ .*

A considerable amount has been written about this problem in the literature. For now we just mention the following result, which is of greatest relevance:

Theorem 1.1.2 (Hofer [H93]). *The Weinstein conjecture holds in the following 3-dimensional cases:*

- $M = S^3$
- ξ is overtwisted
- $\pi_2(M) \neq 0$

The definition of an overtwisted contact structure will be given in the next section.

Theorem 1.1.2 follows from a construction involving holomorphic curves in the so-called *symplectization* of a contact manifold. Given (M, λ) , the symplectization is the manifold $\mathbb{R} \times M$, which admits a special class of symplectic structures of the form

$$\Omega_\varphi = d(\varphi\lambda),$$

where $\varphi : \mathbb{R} \rightarrow (0, \infty)$ is an increasing function, considered here as a function on $\mathbb{R} \times M$. The particular choice of φ is unimportant; in fact, we'll see in Sec. 4.6 that it can sometimes be useful to choose a different class of symplectic forms altogether. The key is that there's a special class of almost complex structures tamed by these forms.

The contact condition implies $d\lambda$ is a nondegenerate 2-form on ξ , so $(\xi, d\lambda)$ is a symplectic vector bundle over M .

Definition 1.1.3. An admissible complex multiplication J on ξ is a smooth fiber-wise linear map $J : \xi \rightarrow \xi$ that satisfies $J^2 = -\text{Id}$ and is compatible with $d\lambda$, meaning that

$$|\cdot|_J^2 := d\lambda(\cdot, J\cdot)$$

defines a metric on the bundle $\xi \rightarrow M$.

Given (M, λ) with an admissible $J : \xi \rightarrow \xi$, we exploit the natural splitting $T(\mathbb{R} \times M) = \mathbb{R} \oplus \mathbb{R}X_\lambda \oplus \xi$ to define an almost complex structure \tilde{J} on the symplectization $\mathbb{R} \times M$ by

$$\partial_a \mapsto X_\lambda, \quad X_\lambda \mapsto -\partial_a, \quad v \mapsto Jv \text{ for } v \in \xi.$$

Here $a : \mathbb{R} \times M \rightarrow \mathbb{R}$ is the coordinate function for the \mathbb{R} -factor and ∂_a is the corresponding coordinate vector field. Observe that \tilde{J} is invariant with respect to the natural \mathbb{R} -action on $\mathbb{R} \times M$.

We consider now \tilde{J} -holomorphic curves

$$\tilde{u} : (\dot{\Sigma}, j) \rightarrow (\mathbb{R} \times M, \tilde{J}),$$

where the domain $\dot{\Sigma} = \Sigma \setminus \Gamma$ is a closed Riemann surface (Σ, j) with a finite set of points $\Gamma \subset \Sigma$ removed. The simplest example of a holomorphic curve in this setting is a so-called *orbit cylinder*. Let $x : \mathbb{R} \rightarrow M$ be a closed orbit of X_λ with period $T > 0$; then it's easy to check that the map $\tilde{u} : \mathbb{R} \times S^1 \rightarrow \mathbb{R} \times M$ defined by

$$\tilde{u}(s, t) = (Ts, x(Tt))$$

satisfies the nonlinear Cauchy-Riemann equation $T\tilde{u} \circ i = \tilde{J} \circ T\tilde{u}$. The domain $(\mathbb{R} \times S^1, i)$ is biholomorphic to the Riemann sphere with two punctures.

The following fact is the key to all dynamical applications of holomorphic curves in contact geometry: all solutions satisfying a finite energy condition look approximately like orbit cylinders near the punctures. The *energy* of any \tilde{J} -holomorphic curve $\tilde{u} : S \rightarrow \mathbb{R} \times M$ is defined as

$$E(\tilde{u}) = \sup_{\varphi \in \mathcal{T}_0} \int_S \tilde{u}^* d(\varphi\lambda),$$

where $\mathcal{T}_0 := \{\varphi \in C^\infty(\mathbb{R}, [0, 1]) \mid \varphi' \geq 0\}$. An easy computation shows that the integrand is nonnegative whenever \tilde{u} is \tilde{J} -holomorphic. In the case where $S = \dot{\Sigma}$ is a closed Riemann surface with finitely many punctures and \tilde{u} is a \tilde{J} -holomorphic curve with $E(\tilde{u}) < \infty$, we call \tilde{u} a *finite energy surface*. These objects were first introduced by Hofer to prove Theorem 1.1.2, and have since been studied in a series of papers by Hofer, Wysocki and Zehnder.

The following notation will be used throughout: $\mathbb{D} \subset \mathbb{C}$ is the closed unit disk, and for $r > 0$, $\mathbb{D}_r \subset \mathbb{C}$ is the closed disk of radius r centered at 0. We use dots to indicate punctured surfaces, so for instance $\dot{\mathbb{D}} = \mathbb{D} \setminus \{0\}$.

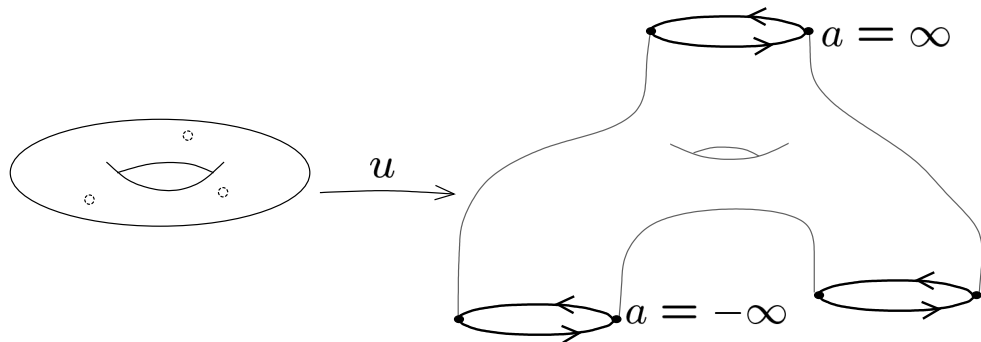

Figure 1.1: A finite energy torus with one positive and two negative punctures.

Proposition 1.1.4 ([H93]). *Suppose $\tilde{u} = (a, u) : \dot{\mathbb{D}} = \mathbb{D} \setminus \{0\} \rightarrow \mathbb{R} \times M$ is a \tilde{J} -holomorphic map with $0 < E(\tilde{u}) < \infty$. If \tilde{u} is bounded, then \tilde{u} extends to a \tilde{J} -holomorphic map $\mathbb{D} \rightarrow \mathbb{R} \times M$. Otherwise, \tilde{u} is a proper map, and for every sequence $s_k \rightarrow \infty$ there is a subsequence such that the loops $t \mapsto u(e^{-2\pi(s_k+it)})$ converge in $C^\infty(S^1, M)$ to a loop $t \mapsto x(Qt)$. Here $x : \mathbb{R} \rightarrow M$ is a periodic orbit of X_λ with period $T = |Q|$, where*

$$Q = -\lim_{\epsilon \rightarrow 0} \int_{\partial \mathbb{D}_\epsilon} u^* \lambda \neq 0 \quad (1.1.4)$$

It follows that any finite energy pseudoholomorphic map $\tilde{u} = (a, u) : \dot{\Sigma} = \Sigma \setminus \Gamma \rightarrow \mathbb{R} \times M$ behaves in this way at each puncture (see Figure 1.1)—this applies equally well when (Σ, j) is a compact Riemann surface *with boundary* and interior punctures $\Gamma \subset \text{int } \Sigma$. The number $Q \in \mathbb{R} \setminus \{0\}$ defined in (1.1.4) is called the *charge* of the puncture, and we call the puncture positive/negative in accordance with the sign of Q . It turns out also that a nonremovable puncture $z_0 \in \Gamma$ is positive if and only if $a(z)$ approaches $+\infty$ as $z \rightarrow z_0$; $a(z) \rightarrow -\infty$ at negative punctures. This partitions the set of punctures into two subsets

$$\Gamma = \Gamma^+ \cup \Gamma^-.$$

One can use the maximum principle to prove that for finite energy surfaces (i.e. when Σ is closed), there is always at least one positive puncture; see [HWZ95a].

It's important to note that the orbit $x(t)$ need not be simply covered: in general there is a minimal period $\tau > 0$ and a positive integer k such that $T = k\tau$. Whenever we talk about a “periodic orbit” $P \subset M$, it is to be understood that P refers to both an embedded circle in M and a covering number $k \in \mathbb{N}$; though we will sometimes abuse the notation and treat P as a set, when there is no ambiguity. We will also

sometimes allow a *negative* covering number $-k$: this is just short-hand notation for a k -fold covered orbit that occurs as the asymptotic limit at a *negative puncture*. The notation makes sense if one observes that $t \mapsto u(e^{-2\pi(s_k+it)})$ converges to a negative cover of the underlying orbit when Q is negative.

Prop. 1.1.4 makes no guarantee about the uniqueness of the orbit $x(t)$; indeed, one cannot exclude the possibility of a finite energy surface that has multiple distinct asymptotic limits at the same puncture. However, this cannot happen if the orbit is nondegenerate or Morse-Bott. Let $\Phi_\lambda^t : M \rightarrow M$ be the flow of the Reeb vector field for time t . It follows from the definition of X_λ that $T\Phi_\lambda^t$ preserves the contact structure.

Definition 1.1.5. *A T -periodic orbit $x(t)$ with $x(0) = p$ is nondegenerate if the linear map $d\Phi_\lambda^T(p)|_{\xi_p} : \xi_p \rightarrow \xi_p$ does not have 1 as an eigenvalue. The contact form λ is called nondegenerate if all periodic orbits are nondegenerate.*

Definition 1.1.6. *A Morse-Bott manifold of T -periodic orbits $N \subset M$ is a submanifold N tangent to X_λ such that for every $p \in N$, $\Phi_\lambda^T(p) = p$ and $\ker(d\Phi_\lambda^T(p) - \text{Id})|_{\xi_p} = T_p N \cap \xi_p$. We call λ Morse-Bott nondegenerate (or simply Morse-Bott) if the set of periods of X_λ is discrete, and if for every $T > 0$, the set $N_T = \{p \in M \mid \Phi_\lambda^T(p) = 0\}$ is a closed Morse-Bott manifold.*

Our main interest will be in Morse-Bott manifolds that have a few extra nice properties.

Definition 1.1.7. *A submanifold $N \subset M$ will be called a simple Morse-Bott submanifold if*

- (i) N is closed,
- (ii) N is foliated by periodic orbits that all have the same minimal period $\tau > 0$,
and
- (iii) for every $k \in \mathbb{N}$, N is a Morse-Bott manifold of $k\tau$ -periodic orbits.

Informally, we will call an orbit *Morse-Bott* if it belongs to a simple Morse-Bott manifold. In this case the asymptotic result of Prop. 1.1.4 can be strengthened considerably.

Proposition 1.1.8 ([HWZ96a], [HWZ96b] and [Bo02]). *Let $\tilde{u} = (a, u) : \mathbb{D} \rightarrow \mathbb{R} \times M$ be a finite energy punctured disk and suppose the T -periodic orbit $x(t)$ provided by Prop. 1.1.4 is either nondegenerate or belongs to a simple Morse-Bott manifold. Then the loops*

$$t \mapsto u(e^{-2\pi(s+it)})$$

converge exponentially fast in $C^\infty(S^1, M)$ to $x(Qt)$ as $s \rightarrow \infty$. Moreover, the functions

$$t \mapsto \frac{a(e^{-2\pi(s+it)})}{s}$$

converge in $C^\infty(S^1, \mathbb{R})$ to the constant Q as $s \rightarrow \infty$.

We defer a more precise discussion of the meaning of “exponentially fast” to Appendix A, Theorem A.2.2.

Definition 1.1.9. A \tilde{J} -holomorphic curve $\tilde{u} : \dot{\Sigma} \rightarrow \mathbb{R} \times M$ will be called asymptotically cylindrical if it behaves as in Prop. 1.1.8 (more precisely Theorem A.2.2) near each puncture $z \in \Gamma$.

Hofer’s proof of the Weinstein conjecture for the cases mentioned in Theorem 1.1.2 establishes a periodic orbit as the asymptotic limit of a finite energy plane. This plane is derived from a sequence of holomorphic disks by a “bubbling off” process, exploiting the noncompactness of the space of holomorphic disks and the properties of its natural compactification. A crucial ingredient here is a uniform energy bound for the holomorphic disks; this guarantees that even as the sequence technically fails to be compact, it gives rise to something with asymptotically cylindrical behavior. We will use a similar line of argument in Chapter 5, constructing finite energy surfaces by degenerating punctured holomorphic curves with boundary.

1.2 Finite energy foliations

From now on, we assume $\dim M = 3$. The more general situation is of course quite interesting: one can use ideas similar to Floer homology and Gromov-Witten theory to derive invariants of contact manifolds in any dimension, cf. [EGH00]. But in dimension 3, holomorphic curves have some especially nice properties resulting from the fact that $3 + 1 = 2 + 2$.

For example, consider a finite energy plane

$$\tilde{u} = (a, u) : \mathbb{C} \rightarrow \mathbb{R} \times M$$

with a nondegenerate asymptotic limit $P \subset M$, and assume \tilde{u} is embedded. Using a symplectic trivialization of the bundle $u^*\xi \rightarrow M$ to define a trivialization of ξ along P , one can associate with any nondegenerate periodic orbit a Conley-Zehnder index $\mu_{\text{CZ}}(P)$. Now, if it happens that $\mu_{\text{CZ}}(P) = 3$, we can use some intersection theory and the Fredholm theory developed in [HWZ99] to conclude the following:

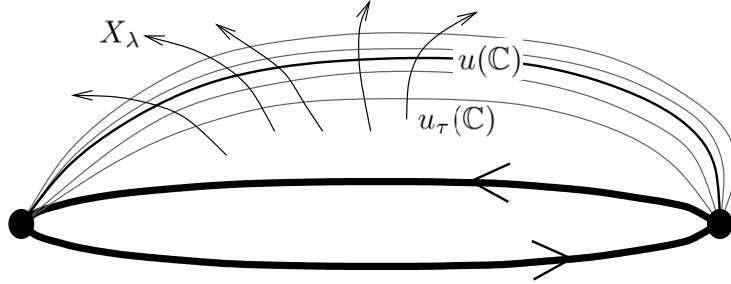

Figure 1.2: If an embedded finite energy plane has an asymptotic limit with Conley-Zehnder index 3, the Fredholm theory gives a smooth family of planes foliating a neighborhood in M and transverse to X_λ .

- (i) There is a 2-dimensional family of embedded finite energy planes $\tilde{u}_\tau = (a_\tau, u_\tau)$ near \tilde{u} , all mutually non-intersecting.
- (ii) The maps $u_\tau : \mathbb{C} \rightarrow M$ are all embedded, and the images of any two are either identical or disjoint.

Thus a single plane \tilde{u} with the right kind of asymptotic data gives rise to a family that foliate a neighborhood of $\tilde{u}(\mathbb{C})$ in $\mathbb{R} \times M$; even better, they foliate a neighborhood of $u(\mathbb{C})$ in M , and it follows easily from the nonlinear Cauchy-Riemann equation that this foliation is transverse to the Reeb vector field (Figure 1.2).

One may ask whether there is any global version of this local behavior. The first results of this type were established by Hofer, Wysocki and Zehnder in [HWZ95b] and [HWZ98], for the standard contact structure on S^3 . They proved that under certain circumstances, S^3 can be presented as a planar open book decomposition, with pages given by finite energy planes that are all asymptotic to the same non-degenerate “binding orbit” P , with $\mu_{CZ}(P) = 3$. This defines a smooth foliation of $S^3 \setminus P$ by an S^1 -parametrized family of open disks with boundary at P (see Figure 1.3). The symplectization $\mathbb{R} \times (S^3 \setminus P)$ is itself foliated by an \mathbb{R} -invariant family of holomorphic planes; adding the orbit cylinder over P , this becomes a holomorphic foliation of $\mathbb{R} \times S^3$.

Finite energy foliations provide a natural generalization of this idea. Let (M, λ) be a closed contact 3-manifold with an admissible complex multiplication J on the contact structure $\xi = \ker \lambda$. The associated almost complex structure on $\mathbb{R} \times M$ is always denoted by \tilde{J} .

Definition 1.2.1. A finite energy foliation for (M, λ, J) is a smooth two-dimensional foliation \mathcal{F} of $\mathbb{R} \times M$ such that

1. Each leaf $F \in \mathcal{F}$ can be presented as the image of an embedded \tilde{J} -holomorphic finite energy surface, and there exists a constant that bounds the energy of every leaf uniformly.
2. For every leaf $F \in \mathcal{F}$, the set $\sigma + F := \{(\sigma + a, m) \mid (a, m) \in F\}$ for $\sigma \in \mathbb{R}$ is also a leaf of the foliation, and thus either disjoint from or identical to F .

A foliation is called spherical if every leaf is a finite energy (punctured) sphere.

We shall often abuse notation and write $\tilde{u} \in \mathcal{F}$, meaning that the finite energy surface \tilde{u} parametrizes a leaf of \mathcal{F} . The \mathbb{R} -invariance assumption says that $\tilde{u} = (a, u) \in \mathcal{F}$ if and only if $\tilde{u}^\sigma := (a + \sigma, u) \in \mathcal{F}$ for all $\sigma \in \mathbb{R}$. This has several consequences for the projection of \mathcal{F} to the underlying contact manifold.

Proposition 1.2.2. *Let \mathcal{F} be a finite energy foliation. Then*

- (i) *If $P \subset M$ is a periodic orbit which is an asymptotic limit for some leaf $\tilde{u} \in \mathcal{F}$, then the orbit cylinder $\mathbb{R} \times P$ is also a leaf of \mathcal{F} .*
- (ii) *For each leaf $\tilde{u} = (a, u) : \dot{\Sigma} \rightarrow \mathbb{R} \times M$ of \mathcal{F} that is not an orbit cylinder, the map $u : \dot{\Sigma} \rightarrow M$ is injective and does not intersect its asymptotic limits.*
- (iii) *If $\tilde{u} = (a, u) : \dot{\Sigma} \rightarrow \mathbb{R} \times M$ and $\tilde{v} = (b, v) : \dot{\Sigma}' \rightarrow \mathbb{R} \times M$ are two leaves of \mathcal{F} , then $u(\dot{\Sigma})$ and $v(\dot{\Sigma}')$ are either disjoint or identical.*

Proof. We prove (i) by an intersection argument: assume P is an asymptotic limit of $\tilde{u} = (a, u) \in \mathcal{F}$, and pick any point $p \in P$. This point is in the image of some finite energy surface $\tilde{v} = (b, v) : \dot{\Sigma}' \rightarrow \mathbb{R} \times M$ which parametrizes another leaf of \mathcal{F} . Suppose \tilde{v} is not an orbit cylinder and $v(z_0) = p \in P$. Since $\mathbb{R} \times P$ is an embedded holomorphic curve, one can apply the similarity principle as in [MS04] to analyze the intersection of \tilde{v} with $\mathbb{R} \times P$, finding a circle $C \subset \dot{\Sigma}'$ around z_0 such that $v(C)$ winds positively around P . Then \tilde{v} must intersect \tilde{u}^σ for some $\sigma \in \mathbb{R}$, and we have a contradiction.

A useful immediate consequence is that if $\tilde{u} = (a, u)$ is not an orbit cylinder, all of its asymptotic limits are disjoint from the image of $u : \dot{\Sigma} \rightarrow M$.

To prove (iii), suppose $\tilde{u} = (a, u)$ and $\tilde{v} = (b, v)$ are two leaves such that $u(z_1) = v(z_2)$. Then there is a number $\sigma \in \mathbb{R}$ such that $\tilde{u}(z_1) = \tilde{v}^\sigma(z_2)$, hence \tilde{u} and \tilde{v}^σ parametrize the same leaf of \mathcal{F} . So u and v have the same image.

For (ii), assume $\tilde{u} = (a, u)$ is a leaf and $u(z_1) = u(z_2)$ for two distinct points $z_1, z_2 \in \dot{\Sigma}$. Then there is a number $\sigma \in \mathbb{R}$ such that $\tilde{u}^\sigma(z_1) = \tilde{u}(z_2)$, thus \tilde{u} and \tilde{u}^σ have identical images; in fact, $\tilde{u}^{k\sigma}(\dot{\Sigma}) = \tilde{u}(\dot{\Sigma})$ for all $k \in \mathbb{Z}$. Now pick $z_0 \in \dot{\Sigma}$ and $z_k \in \dot{\Sigma}$ such that $\tilde{u}(z_k) = \tilde{u}^{k\sigma}(z_0)$, so

$$u(z_k) = u(z_0) \quad \text{and} \quad a(z_k) = a(z_0) + k\sigma.$$

Clearly a subsequence of z_k approaches a puncture as $k \rightarrow \pm\infty$, so by the asymptotic behavior of \tilde{u} , a subsequence of $u(z_k)$ converges to one of the asymptotic limits of \tilde{u} . Thus $u(z_0)$ belongs to such an orbit, and as remarked earlier, this can only happen if \tilde{u} is an orbit cylinder. \square

We'll denote by $\mathcal{P}_{\mathcal{F}} \subset M$ the union of all the closed orbits that occur as asymptotic limits for leaves of \mathcal{F} ; equivalently, this is the projection down to M of all the orbit cylinders in \mathcal{F} . Then Prop. 1.2.2 can be rephrased by saying that an \mathbb{R} -invariant holomorphic foliation of $\mathbb{R} \times M$ induces a *continuous* foliation of $M \setminus \mathcal{P}_{\mathcal{F}}$.

Example 1.2.3. *There is a simple foliation for the standard contact form on S^3 that can be written down explicitly. We define this by regarding S^3 as the unit sphere in \mathbb{C}^2 ; then using the Euclidean inner product $\langle \cdot, \cdot \rangle$ on \mathbb{C}^2 , one can write the contact form λ_0 as*

$$\lambda_0(z)v := \frac{1}{2}\langle iz, v \rangle$$

for $z \in S^3 \subset \mathbb{C}^2$ and $v \in T_z S^3 \subset \mathbb{C}^2$. The Reeb vector field for λ_0 generates the Hopf fibration, so all orbits are periodic (and have the same period). The standard contact structure $\xi_0 = \ker \lambda_0$ consists of complex lines in $TS^3 \subset S^3 \times \mathbb{C}^2$, so there is a natural choice of admissible complex multiplication $J = i : \xi_0 \rightarrow \xi_0$. This defines an almost complex structure \tilde{J} on $\mathbb{R} \times S^3$ which turns out to be integrable; indeed, the diffeomorphism

$$\Phi : (\mathbb{R} \times S^3, \tilde{J}) \rightarrow (\mathbb{C}^2 \setminus \{0\}, i) : (a, m) \rightarrow e^{2a}m$$

is holomorphic. For each $\zeta \in \mathbb{C} \setminus \{0\}$ we now define a \tilde{J} -holomorphic plane

$$\tilde{u}_{\zeta} = (a_{\zeta}, u_{\zeta}) : \mathbb{C} \rightarrow \mathbb{R} \times S^3 : z \mapsto \Phi^{-1}(z, \zeta),$$

and for $\zeta = 0$ there is a cylinder (i.e. punctured plane)

$$\tilde{u}_0 = (a_0, u_0) : \mathbb{C} \setminus \{0\} \rightarrow \mathbb{R} \times S^3 : z \mapsto \Phi^{-1}(z, \zeta).$$

One can check that all of these maps have finite energy; indeed, they are all asymptotic to the Hopf circle $P_{\infty} := \{(e^{2\pi i\theta}, 0)\}$, and \tilde{u}_0 is the orbit cylinder over P_{∞} . The images of u_{ζ} for $\zeta \neq 0$ foliate $S^3 \setminus P_{\infty}$, forming an open book decomposition (Figure 1.3).

It is often desirable to impose some additional conditions on a finite energy foliation. Recall from [HWZ99] that every embedded finite energy surface $\tilde{u} : \Sigma \setminus \Gamma \rightarrow \mathbb{R} \times M$ with nondegenerate asymptotic limits has an associated Fredholm index:

$$\text{Ind}(\tilde{u}) = \mu_{\text{CZ}}(\tilde{u}) - \chi(\Sigma) + \#\Gamma,$$

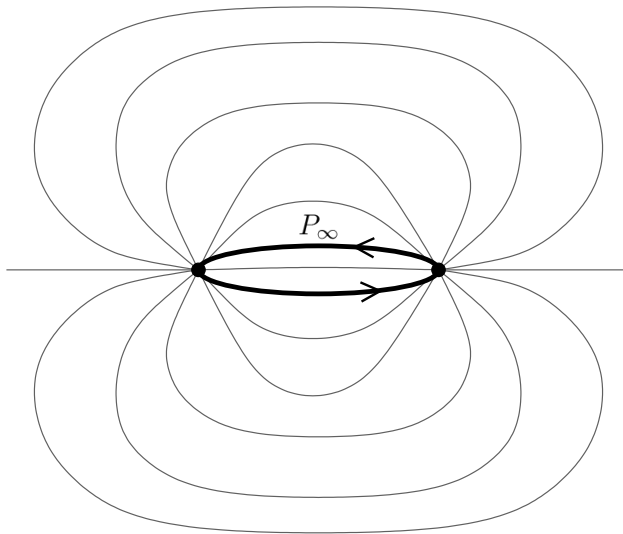

Figure 1.3: A planar open book decomposition of $S^3 = \mathbb{R}^3 \cup \{\infty\}$, with binding orbit P_∞ .

where $\mu_{\text{CZ}}(\tilde{u})$ is the Conley-Zehnder index, as defined in [HWZ95a]. This is the index of the linearized Cauchy-Riemann operator which detects embedded holomorphic curves in a neighborhood of \tilde{u} with the same asymptotic limits. If this operator is surjective, then every finite energy surface sufficiently close to \tilde{u} is part of a smooth family with dimension $\text{Ind}(\tilde{u})$, and one would of course like to assume that this family is the same as the obvious family defined by the foliation. In this case the foliation is stable under perturbations of the data, since one can apply the implicit function theorem to deform each leaf when the complex structure is perturbed. This motivates the following definition.

Definition 1.2.4. *A finite energy foliation \mathcal{F} is called stable if $\mathcal{P}_{\mathcal{F}}$ is a finite union of nondegenerate Reeb orbits, and for every leaf $F \in \mathcal{F}$ outside of $\mathbb{R} \times \mathcal{P}_{\mathcal{F}}$, F is parametrized by a finite energy surface $\tilde{u} = (a, u)$ such that*

1. *The linearized Cauchy-Riemann operator at \tilde{u} is surjective, and all neighboring finite energy surfaces obtained by the implicit function theorem are also leaves of the foliation.*
2. *The map $u : \dot{\Sigma} \rightarrow M$ has no critical points.*

Both conditions in this definition are essentially algebraic: we require that each leaf should have “the right Fredholm index” and that the algebraic count of its

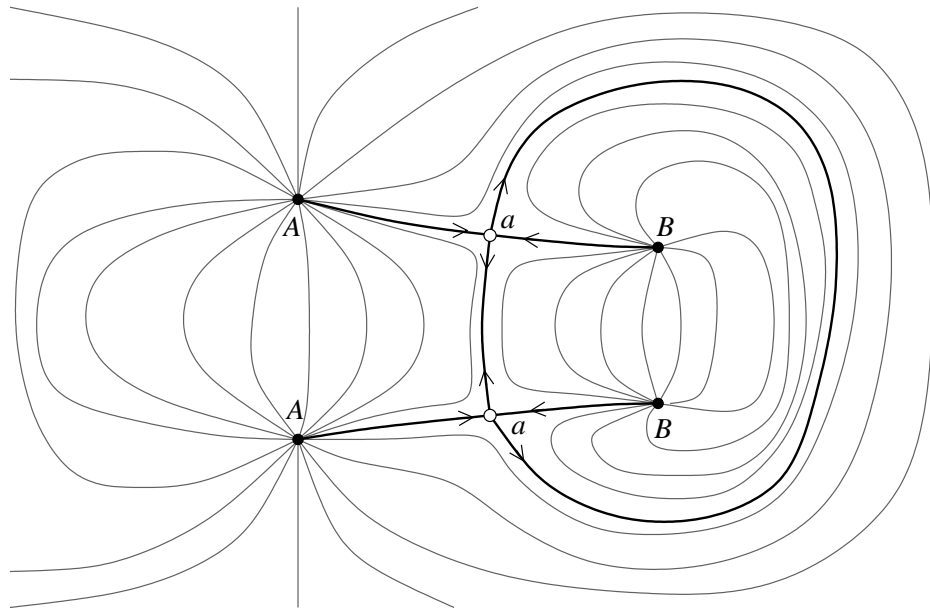

Figure 1.4: A cross section of a stable finite energy foliation on $S^3 = \mathbb{R}^3 \cup \{\infty\}$, with three asymptotic orbits cutting transversely through the page. The hyperbolic orbit a is the limit of two rigid planes, and is connected to two elliptic orbits A and B by rigid cylinders. All other leaves are index 2 planes asymptotic to A or B . Arrows represent the signs of the punctures at a : a puncture is positive/negative if the arrow points away/toward the orbit.

critical points is zero. The latter implies immediately that if $\tilde{u} = (a, u) \in \mathcal{F}$ is not an orbit cylinder, then $u : \dot{\Sigma} \rightarrow M$ is an embedding. As for the Fredholm index, it must be either 1 or 2; it cannot be 0 except for \mathbb{R} -invariant leaves, which are necessarily orbit cylinders. Leaves with $\text{Ind}(\tilde{u}) = 1$ are called *rigid surfaces*. These belong to 1-parameter families determined by the \mathbb{R} -action, and thus appear to be isolated when projected down to M . Likewise, index 2 leaves belong to 2-parameter families, which project down to 1-parameter families in M . In this way, stable finite energy foliations give a geometric decomposition of the underlying contact manifold:

Proposition 1.2.5. *Let $p : \mathbb{R} \times M \rightarrow M$ be the projection onto the second factor. Given a stable finite energy foliation \mathcal{F} for (M, λ, J) , the surfaces*

$$p(\mathcal{F}) := \{p(F) \mid F \in \mathcal{F} \text{ such that } F \subset \mathbb{R} \times (M \setminus \mathcal{P}_{\mathcal{F}})\}$$

form a smooth 1-dimensional foliation of $M \setminus \mathcal{P}_{\mathcal{F}}$, with all leaves transverse to the Reeb vector field X_{λ} .

The transversality $u \pitchfork X_{\lambda}$ holds whenever $\tilde{u} = (a, u)$ is a \tilde{J} -holomorphic curve in $\mathbb{R} \times M$ with $u : \dot{\Sigma} \rightarrow M$ immersed.

Remark 1.2.6. *The foliation of (S^3, λ_0, i) described in Example 1.2.3 is not technically stable since all the Reeb orbits on (S^3, λ_0) are degenerate, but with an intelligent choice of coordinates near P_{∞} it can be turned into a stable foliation by a small perturbation of λ_0 . See Example 3.2.1.*

One expects that stable finite energy foliations should generally be spherical, due to algebraic relations that connect the topology of Σ with the the Fredholm index $\text{Ind}(\tilde{u})$ and the number of critical points of $u : \dot{\Sigma} \rightarrow M$. In particular, a necessary and sufficient condition for u to be immersed is the vanishing of the homotopy invariant $\text{wind}_{\pi}(\tilde{u})$ defined in [HWZ95a], and we have the inequality

$$2 \text{wind}_{\pi}(\tilde{u}) \leq \text{Ind}(\tilde{u}) + 2g + \#\Gamma_0 - 2, \tag{1.2.1}$$

where g is the genus of Σ and $\Gamma_0 \subset \Gamma$ is the set of punctures with even Conley-Zehnder index. (We will prove a generalization of this formula for punctured holomorphic curves with boundary in Chapter 4.) We see that the right hand side of (1.2.1) cannot be zero if the genus is positive. In this situation, one can use Fredholm theory with exponential weights to prove that finite energy surfaces with $\text{wind}_{\pi}(\tilde{u}) = 0$ do not exist generically. On the other hand, C. Abbas, K. Cieliebak and H. Hofer [ACH04] have recently considered a generalization of the holomorphic curve equation which may provide a suitable setup for defining stable finite energy foliations with higher genus.

In the present work, we will discuss only spherical foliations. Their existence has previously been established for generic contact forms on the tight 3-sphere, see [HWZ03b]. Recall that contact structures ξ on a 3-manifold M can be classified as either *tight* or *overtwisted*, where overtwisted means there exists an embedded disk $D \subset M$ such that $T(\partial D) \subset \xi$ but $TD|_{\partial D} \neq \xi|_{\partial D}$. The standard contact structure ξ_0 on S^3 is tight, and in fact by a theorem of Eliashberg [E92], all tight contact structures ξ on S^3 are contactomorphic to ξ_0 . Thus every tight contact form on S^3 is equivalent to $f\lambda_0$ for some smooth positive function f .

Theorem 1.2.7 ([HWZ03b]). *There exist stable spherical finite energy foliations on $(S^3, f\lambda_0, J)$ for a generic set of f and J .*

This has some remarkable dynamical consequences since the induced singular foliation on S^3 is transverse to the Reeb flow. Thus a stable foliation produces a global system of transversal sections, with which one can prove:

Corollary 1.2.8 ([HWZ03b]). *For a generic set of smooth functions $f : S^3 \rightarrow (0, \infty)$, the Reeb vector field defined by $\lambda = f\lambda_0$ on S^3 has precisely either two or infinitely many periodic orbits.*

1.3 Main result: Morse-Bott foliations in the overtwisted case

The present work is motivated by the goal of extending the existence result of [HWZ03b] to other manifolds and other contact structures. To accomplish this, we develop a technique for modifying families of holomorphic curves $\tilde{u} : \dot{\Sigma} \rightarrow \mathbb{R} \times M$ under surgery along links $K \subset M$ that are transverse to both the contact structure and the holomorphic curves. Roughly, the idea is to cut pieces out of the domain $\dot{\Sigma}$, replacing \tilde{u} with a solution to a boundary value problem whose image stays outside of a neighborhood of K . After performing surgery, we can then use a “noncompactness argument” to obtain a new family of punctured holomorphic curves by degenerating the boundary.

In the case considered here, this procedure takes a holomorphic open book decomposition of the tight 3-sphere and uses it to create a finite energy foliation with infinitely many asymptotic limits lying in Morse-Bott families.

Recall from [HWZ99] that for a finite energy surface $\tilde{u} : \dot{\Sigma} \rightarrow \mathbb{R} \times M$ with degenerate asymptotic limits, one can use exponential weights to define a suitable Cauchy-Riemann operator whose linearization is Fredholm. This works especially nicely if the asymptotic limits belong to Morse-Bott families of periodic orbits:

then for instance, an embedded index 2 curve has neighbors that are asymptotic to neighboring orbits in a Morse-Bott family. (We'll work out the details of this in Chapter 4.)

Definition 1.3.1. *A finite energy foliation \mathcal{F} is said to be of stable Morse-Bott type if $\mathcal{P}_{\mathcal{F}}$ consists of a finite union of nondegenerate orbits and/or simple 2-dimensional Morse-Bott submanifolds, and for every leaf $F \in \mathcal{F}$ outside of $\mathbb{R} \times (M \setminus \mathcal{P}_{\mathcal{F}})$, F is parametrized by a finite energy surface $\tilde{u} = (a, u)$ such that*

1. *The linearized Cauchy-Riemann operator at \tilde{u} (defined with exponential weights if necessary) is surjective, and all neighboring finite energy surfaces obtained by the implicit function theorem are also leaves of the foliation.*
2. *The map $u : \Sigma \setminus \Gamma \rightarrow M$ has no critical points.*

Just as in the stable case, a foliation \mathcal{F} of stable Morse-Bott type defines a 1-dimensional foliation $p(\mathcal{F})$ of $M \setminus \mathcal{P}_{\mathcal{F}}$ transverse to X_{λ} , where now the singular set $\mathcal{P}_{\mathcal{F}}$ is a union of finitely many nondegenerate periodic orbits and finitely many compact surfaces foliated by Morse-Bott periodic orbits. (The surfaces are tori in particular, since they admit nonvanishing vector fields.)

Here is the main result.

Theorem 1.3.2. *Every homotopy class of coorientable two-plane distributions on a closed orientable three-manifold M contains a contact structure ξ with the following property: there exists a contact form λ with $\ker \lambda = \xi$ and an admissible complex multiplication $J : \xi \rightarrow \xi$ such that (M, λ, J) admits a spherical finite energy foliation of stable Morse-Bott type. The foliation may be assumed to have the following properties for every leaf that is not an orbit cylinder:*

- (i) *all punctures are positive*
- (ii) *all asymptotic limits are simply covered*
- (iii) *each puncture has a different asymptotic limit*

Eliashberg proved in [E89] that two overtwisted contact structures on a closed 3-manifold are contactomorphic if and only if they are homotopic as 2-plane distributions. Combining this with the above theorem yields:

Theorem 1.3.3. *Every closed contact three-manifold with a coorientable overtwisted contact structure can be represented by a contact form that admits a spherical finite energy foliation of stable Morse-Bott type.*

Though we will not prove this here, it should be possible to perturb a Morse-Bott foliation along with a nondegenerate perturbation of the contact form, thus producing a stable finite energy foliation (compare Figures 1.5 and 1.6). This would follow by a gluing argument, using the ideas in [Bo02] to relate moduli spaces of holomorphic curves in a Morse-Bott setup with the moduli spaces in a nondegenerate perturbation. We'll see some explicit examples of such perturbed foliations in Chapter 3. The result of such a gluing argument would be the proof of:

Conjecture 1.3.4. *Every closed contact three-manifold with a coorientable over-twisted contact structure can be represented by a nondegenerate contact form that admits a stable spherical finite energy foliation.*

The stable foliation will generally include some rigid cylinders that have one negative puncture. But it should still be possible to guarantee that all orbits of each leaf are simply covered and distinct.

1.4 Outline of the proof

Our existence result is made possible by the theorem of Martinet [Ma71] and Lutz [Lu71] on the existence of contact structures in closed 3-manifolds. Their work provides a blueprint for creating a contact structure in any given homotopy class of 2-plane distributions on any closed oriented 3-manifold. This can be achieved by a combination of Dehn surgery and so-called *Lutz twists* along transverse links in the tight 3-sphere. We review the result in Chapter 2, and present also a lemma that allows us to work only with links that are presented as closed braids near a particular Hopf circle in S^3 .

In addition, we'll make use of the existence of a particular type of stable finite energy foliation on the tight 3-sphere: for this one can use either a stabilized version of Example 1.2.3, or alternatively the open book decompositions constructed in [HWZ95b]. We will use ingredients from such an open book decomposition of (S^3, ξ_0) to construct a new foliation on some (M, ξ) obtained by surgery and Lutz twists.

To be more precise, we can choose a contact form λ_1 on S^3 with $\ker \lambda_1 = \xi_0$, such that the periodic orbits of X_{λ_1} include two linked Hopf circles P_0 and P_∞ , of which P_∞ is nondegenerate and $\mu_{CZ}(P_\infty) = 3$. There is then an admissible complex multiplication $J_1 : \xi_0 \rightarrow \xi_0$, which determines a corresponding almost complex structure \tilde{J}_1 on $\mathbb{R} \times S^3$, such that there is a smooth S^1 -parametrized family $\tilde{u}_\tau = (a_\tau, u_\tau) : \mathbb{C} \rightarrow \mathbb{R} \times S^3$ of pairwise disjoint, embedded finite energy planes which are all \tilde{J}_1 -holomorphic and asymptotic to P_∞ . The maps $u_\tau : \mathbb{C} \rightarrow S^3$ are embeddings transverse to X_{λ_1} , and they foliate $S^3 \setminus P_\infty$. If we were to include all the

\mathbb{R} -translations of \tilde{u}_τ as well as the orbit cylinder $\mathbb{R} \times P_\infty$, this would give a stable finite energy foliation for (S^3, λ_1, J_1) . Now take an arbitrary oriented link $K \subset S^3$, positively transverse to ξ_0 . By the lemma proved in Chapter 2, we can assume after a transverse isotopy that each component of K is C^∞ -close to some positive cover of the periodic orbit P_0 . Thus we can assume that K is transverse to each of the planes u_τ . The goal will then be to perform surgery on a neighborhood of K and somehow obtain a holomorphic foliation after such a discontinuous change in the data.

The new foliation will include an S^1 -parametrized family derived from the one above, but the surfaces in this family will have extra punctures, and they will not fill all of the new manifold M . In particular, these surfaces will fill only the region outside a set of tori that bound a tubular neighborhood of K (Figure 1.5). Let $K_j \subset K$ be a knot, and choose a small tubular neighborhood N_j bounded by a torus L_j . One result of the surgery will be to modify the contact form so that L_j is a simple Morse-Bott manifold, foliated by periodic orbits which are meridians. In principle, the fate of each of the planes \tilde{u}_τ cutting transversely through K_j is to acquire a new puncture asymptotic to one of the orbits on L_j . *Inside* L_j , we need to create a new foliation from scratch, and this is the subject of Chapter 3. It is in fact the easy part of the argument, because we have enough freedom to choose a contact form with a great deal of symmetry in N_j , so that it becomes possible to write down the Cauchy-Riemann equations and, with a reasonable ansatz, solve them. The foliation thus produced consists of an index 2 family of planes, which project to a 1-dimensional family of disks in S^3 , bounded by the 1-parameter family of periodic orbits on L_j (see Figure 3.2 in Chapter 3). This is the situation after performing a Lutz twist in N_j . If we wish to change the topological type of S^3 to a new manifold M by Dehn surgery, the problem is hardly more complicated: in effect, this just means looking at a solid torus N_j whose periodic orbits belong to a different homotopy class (not meridians) on the boundary L_j . We can similarly solve the Cauchy-Riemann equations and foliate N_j by finite energy cylinders, with one puncture asymptotic to an orbit on L_j and the other one asymptotic to the central axis of N_j . These constructions have much in common with the families of holomorphic curves in an overtwisted $S^1 \times S^2$ considered by Taubes in [T02]. As a bonus, we obtain explicit constructions of foliations for some simple manifolds such as $S^1 \times S^2$ and T^3 , and we will also see how to perturb these Morse-Bott constructions to stable foliations with nondegenerate asymptotic limits.

The hard part is dealing with the situation outside of the neighborhoods N_j , where the family \tilde{u}_τ must be converted into a new S^1 -family of holomorphic curves \tilde{v}_τ with an additional puncture replacing each intersection point of \tilde{u}_τ with K . We accomplish this by considering holomorphic curves defined on Riemann surfaces with

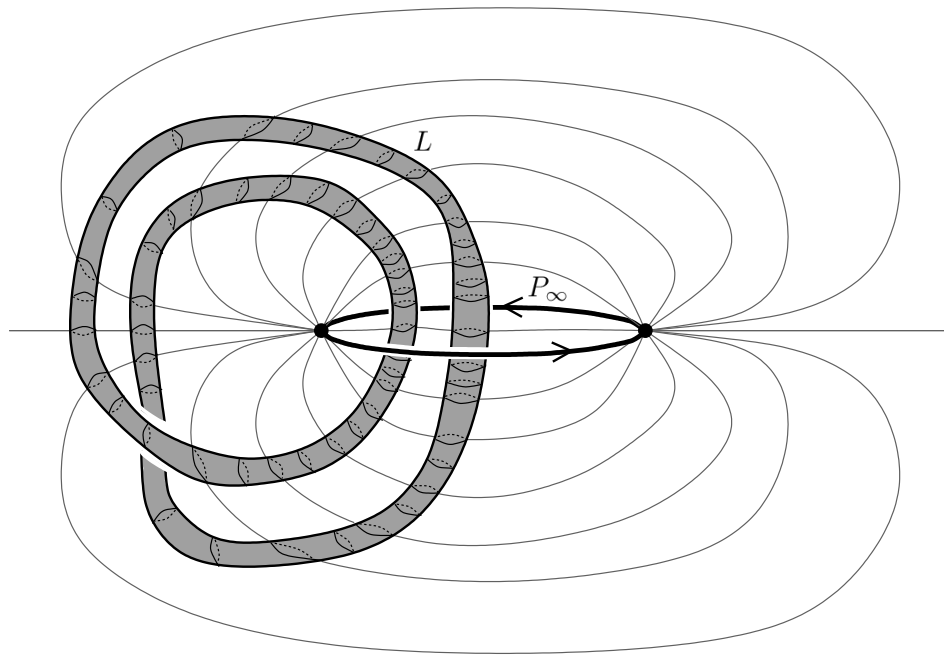

Figure 1.5: The foliation of Morse-Bott type constructed from an open book decomposition of S^3 by surgery along a transverse knot. Here the knot has linking number 2 with the binding orbit P_∞ , and a tubular neighborhood is bounded by the Morse-Bott torus L . Each page of the former open book has two new punctures asymptotic to orbits on L .

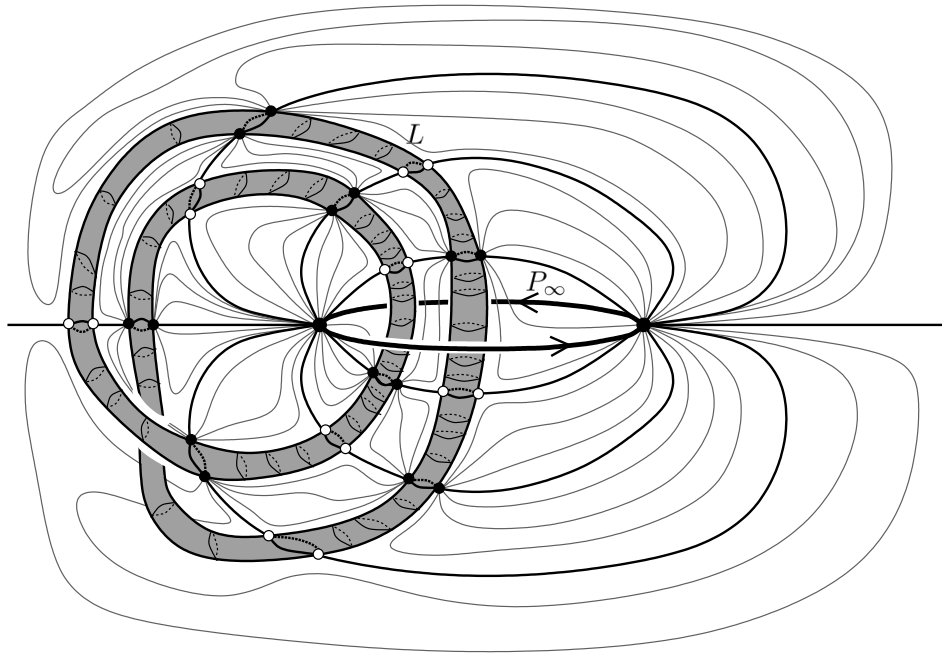

Figure 1.6: A conjectured nondegenerate perturbation of Figure 1.5: here λ is perturbed near L so that most closed orbits are killed, but fourteen nondegenerate orbits remain, alternating between hyperbolic and elliptic. These are connected by rigid cylinders along L . Seven of the original leaves from the Morse-Bott construction are now rigid surfaces, each with two punctures at elliptic orbits (including P_∞) and one hyperbolic. The others are all index 2 surfaces with three punctures at elliptic orbits (including P_∞).

both punctures and boundary. To begin, we take advantage of the fact that K_j is close to P_0 in order to make a C^1 -small change in λ_1 , so that the new contact form λ has its Reeb vector field X_λ tangent to L_j . The implicit function theorem and a simple compactness result allow us to perturb the open book decomposition $\{\tilde{u}_\tau\}$ along with this change in the data. Since u_τ cuts transversely through L_j , there is a unique open disk $\mathcal{D}_j \subset \mathbb{C}$ that can be cut out of the domain so that the restriction of u to $\dot{\Sigma} = \mathbb{C} \setminus \mathcal{D}_j$ has its image in $S^3 \setminus N_j$ and maps the boundary $\partial\Sigma$ into L_j . It turns out that for any smooth function $G_j : L_j \rightarrow \mathbb{R}$, the graph

$$\tilde{L}_j = \{(G_j(x), x) \in \mathbb{R} \times M \mid x \in L_j\}$$

is a totally real submanifold of $\mathbb{R} \times S^3$. Clearly then, we can define such a surface \tilde{L}_j so that any of the restricted maps $\tilde{u}_\tau : \dot{\Sigma} \rightarrow \mathbb{R} \times S^3$ satisfies the totally real boundary condition $\tilde{u}_\tau(\partial\Sigma) \subset \tilde{L}_j$. The properties of this mixed boundary value problem are explored in detail in Chapter 4. In particular, we develop analogs of many of the standard results for finite energy surfaces that were proved in [HWZ96a], [HWZ95a] and [HWZ99], involving asymptotic behavior, algebraic embedding controls, Fredholm theory and transversality. A technical complication arises due to the fact that the totally real submanifolds \tilde{L}_j are not generally Lagrangian with respect to the usual symplectic form $d(e^a\lambda)$, thus one cannot obtain *a priori* energy bounds for this problem. We fix this in Sec. 4.6 by developing a generalized concept of energy, which does satisfy an *a priori* bound if \tilde{L}_j is made to satisfy a milder requirement, called the *pseudo-Lagrangian* condition. This requirement is not very flexible, but it doesn't need to be, because we will see there is a trick for turning a solution with pseudo-Lagrangian boundary conditions into one whose boundary is actually Lagrangian.

After dealing with the technical preparations in Chapter 4, Chapter 5 completes the proof of Theorem 1.3.2. Most of the technical work here consists of bubbling off arguments: we must prove that if our solutions can be perturbed by the implicit function theorem, then they also allow more than a *small* perturbation. This enables us to homotop the S^1 -family of punctured holomorphic curves with boundary $\tilde{u}_\tau : \dot{\Sigma} \rightarrow \mathbb{R} \times S^3$, as the contact form is gradually twisted near the tori L_j . (The twist is somewhat more violent inside L_j , but this doesn't matter because our solutions stay outside.) Eventually, a *noncompactness* result is used to produce the final product: as λ is twisted so that the Reeb orbits on L_j become meridians, the solutions \tilde{u}_τ cannot survive as punctured holomorphic curves with boundary. What happens instead is that the complex structure on the domain $\dot{\Sigma}$ degenerates until, in the limit, each component of $\partial\Sigma$ shrinks to a new puncture. The result is an S^1 -parametrized family of finite energy surfaces asymptotic to both P_∞ and the new family of periodic orbits foliating L_j .

1.5 Toward a homotopy theory of finite energy foliations

Concordance of foliations and the Weinstein conjecture

Let us make some remarks about the larger context that this work fits into. Theorem 1.3.2 and the corollary for overtwisted contact structures make up one ingredient in a joint project with H. Hofer and two other Ph.D. students, R. Siefring and J. Fish, to develop what might be called a *homotopy theory* for finite energy foliations. Another important step in this program would be to formalize and prove the following:

Assume (M, λ_0, J_0) are generic and admit a stable finite energy foliation \mathcal{F}_0 . Then for generic data (λ_1, J_1) with $\ker \lambda_1 = \ker \lambda_0$, there should also be a stable finite energy foliation \mathcal{F}_1 for (M, λ_1, J_1) . The two foliations should be related to each other by a foliation \mathcal{F}_{10} of $\mathbb{R} \times M$ by embedded \tilde{J}_{01} -holomorphic curves, where \tilde{J}_{01} is a non- \mathbb{R} -invariant almost complex structure interpolating between \tilde{J}_0 and \tilde{J}_1 .

The idea here is that one could use a foliation \mathcal{F}_0 to produce not only a foliation for the new data (λ_1, J_1) , but also a non- \mathbb{R} -invariant holomorphic foliation \mathcal{F}_{10} of a symplectic cobordism connecting (M, λ_0, J_0) to (M, λ_1, J_1) . \mathcal{F}_{10} may be called a *concordance of foliations*. For any such object, there should be a well defined notion of *asymptotic foliations* \mathcal{F}_{10}^\pm , defined by taking “limits” of the foliations \mathcal{F}_{10}^σ defined by translation $(a, m) \mapsto (a + \sigma, m)$ as $\sigma \rightarrow \pm\infty$. The conjecture then says that one can find \mathcal{F}_1 and \mathcal{F}_{10} such that $\mathcal{F}_{10}^+ = \mathcal{F}_0$ and $\mathcal{F}_{10}^- = \mathcal{F}_1$.

A simple (though trivial) example of a concordance of foliations can be constructed as follows: given a foliation \mathcal{F} of (M, λ, J) , choose a smooth function $f : \mathbb{R} \rightarrow (0, \infty)$ such that $f' \geq 0$ and $f(a)$ is constant for sufficiently large $|a|$, and define a new almost complex structure \hat{J} that matches \tilde{J} on $\xi = \ker \lambda$ but takes ∂_a to $X_{f\lambda} = \frac{1}{f(a)}X_\lambda$ at $(a, m) \in \mathbb{R} \times M$. If $\tilde{u} = (a, u)$ parametrizes a leaf of \mathcal{F} , one can find a smooth function $g : \mathbb{R} \rightarrow \mathbb{R}$ so that the map $\tilde{v} = (g(a), u)$ is \hat{J} -holomorphic. All of these together form a \hat{J} -holomorphic foliation $\hat{\mathcal{F}}$ of $\mathbb{R} \times M$, whose asymptotic foliations $\hat{\mathcal{F}}^\pm$ are just \mathcal{F} with the \mathbb{R} -factor rescaled. This construction is the first step in a proposed plan for constructing nontrivial concordances between foliations for distinct contact forms.

Combined with Theorem 1.3.3, this would establish the existence of a stable finite energy foliation for generic overtwisted contact forms on a closed three-manifold.

One might next extend this result to generic tight contact forms by the following trick. Given (M, λ) , let (M, λ') be the connected sum of M with a generic overtwisted three-sphere. Then this would admit a finite energy foliation, and one can imagine pinching off the overtwisted sphere by a stretching argument, thus obtaining a finite energy foliation on (M, λ) . If this succeeds, we obtain:

Every generic (M, λ, J) admits a (singular) finite energy foliation.

The word “singular” has been added here because there are known examples of closed contact 3-manifolds that generically *cannot* admit stable finite energy foliations, as we have defined them—though the methods used for studying holomorphic foliations may still yield interesting results in these cases. Take for instance a closed Riemann surface S with $\chi(S) < 0$, and consider the unit tangent bundle $M = S^1TS$ defined by the complete hyperbolic metric h . This has a natural contact form whose closed orbits correspond to closed geodesics of h , and they all have Conley-Zehnder index 0. This last fact presents a problem because, as we will see in Sec. 4.5.5, an abundance of even punctures tends to kill the transversality and embeddedness results that make this theory work. Indeed, combining the index formula $\text{Ind}(\tilde{u}) = \mu_{\text{CZ}}(\tilde{u}) - \chi(\Sigma) + \#\Gamma = 2g - 2 + \#\Gamma_0$ with the inequality (1.2.1), we have

$$\text{wind}_\pi(\tilde{u}) \leq \text{Ind}(\tilde{u}).$$

Thus if \tilde{u} is an index 1 or 2 leaf of a stable foliation, this must be a strict inequality, and a weighted Fredholm theory argument can then be used to prove that such curves do not exist generically. Similar inequalities appear in the Fredholm theory and intersection theory, showing that generically, embedded finite energy surfaces in this setting must be expected to have a fixed finite number of intersections with their neighbors.

If the theory can be extended to this case, then one must introduce a more general notion of “singular” finite energy foliations, for which different leaves may have isolated intersections and the projected leaves are not embedded but have self-intersections on some one-dimensional subset of M . We will not explore these ideas further here.

Singular or otherwise, the generic existence of foliations would have the following nice consequence. Given *any* contact form λ on a three-manifold M , we can approximate it by generic contact forms λ_k which admit finite energy foliations. The foliations come with a crude energy bound $c = c(\lambda)$, which also bounds the periods of their spanning orbits. Thus for each λ_k there is a periodic orbit $x_k(t)$ with period bounded by $c(\lambda)$, and in the limit, Arzelá-Ascoli yields a periodic orbit $x(t)$ for λ . This would then settle the Weinstein conjecture in dimension three.

Actually the result would prove more than just existence of a periodic orbit: as was shown in [HWZ03b], the existence of a stable finite energy foliation leads to the conclusion that generic tight contact forms on S^3 admit either two or infinitely many periodic orbits. It has been suggested that similar results may hold for all closed contact three-manifolds as long as λ is sufficiently generic (e.g. one would have to assume that all stable and unstable manifolds of hyperbolic orbits intersect transversely).

Floer-type invariants

In addition to the potential dynamical results described above, a homotopy theory of foliations may provide insight into contact geometry and topology. It should for instance be possible to encode the data of a finite energy foliation algebraically in the form of a Floer-type theory, leading potentially to new invariants that would combine topological and contact information in an interesting way. We'll explore this idea speculatively in Chapter 6. The inspiration comes from observing the relationship between index 2 families of leaves and index 1 rigid surfaces in stable foliations: projecting down to the contact manifold, an index 2 family looks like a 1-parameter family that is either compact (parametrized by S^1) or degenerates into a “broken” rigid surface with two levels (cf. Figures 1.4 and 1.6). The crucial observation is that both this compactness statement and the corresponding gluing theorem can be expressed without reference to any holomorphic curves other than those that make up the foliation. This suggests that such behavior could be encoded algebraically as in contact homology or rational symplectic field theory, creating a version of these theories that sees only the moduli space of embedded holomorphic curves belonging to a particular foliation. This would *not* be a contact invariant—it would depend on the given foliation—but it should behave functorially with respect to concordance. Then one could possibly construct invariants by considering, for a given (M, ξ) , the set of all stable foliations, up to equivalence by concordance. Such a theory would likely have relations to the various other holomorphic curve and gauge theoretic invariants that have found application to three-dimensional contact geometry in recent years: e.g. Hutchings' embedded contact homology [Hu02], Ozsváth and Szabó's Heegaard Floer homology [OS02], the Seiberg-Witten Floer homology of Kronheimer and Mrowka [K98], and of course symplectic field theory [EGH00].

In Chapter 6, we will outline in more detail what such a theory might look like and, without worrying about the technical complications, do some simple computations based on the stable foliations constructed in Chapter 3. This leads to some conjectures about concordance of foliations e.g. there is a contact manifold admit-

ting two foliations that are not concordant. We will also argue (but not prove) that the algebraic invariants, defined initially only for stable foliations, are also well defined for foliations of stable Morse-Bott type.

Chapter 2

Contact Structures and Transverse Surgery

2.1 The theorem of Martinet and Lutz

Our construction of finite energy foliations rests fundamentally on a procedure due to Martinet [Ma71] and Lutz [Lu71] for creating contact structures on general closed oriented 3-manifolds. We begin with a review of this construction, skipping the proofs, which can be found in the excellent lecture notes by Geiges [Ge03]. Sec. 2.2 will then prove a lemma about transverse links in S^3 which is needed for the compactness arguments later on.

Dehn surgery

A basic fact in three-dimensional topology is that all closed oriented 3-manifolds can be produced by integral Dehn surgery along links in S^3 . We review the basic ideas here, referring to [Sa99] or [PS] for the details. Let $K \subset S^3$ be an oriented knot, with tubular neighborhood N_K , and denote by $\overline{B^2(0)}$ the closed unit ball in \mathbb{R}^2 . A *rational Dehn surgery* along K is accomplished by cutting N_K out of S^3 and replacing it by another solid torus $S^1 \times \overline{B^2(0)}$, gluing the boundaries by some homeomorphism $\psi : \partial(S^1 \times \overline{B^2(0)}) \rightarrow \partial N_K$. This surgery can be described by a number $p/q \in \mathbb{Q} \cup \{\infty\}$ as follows.

Identify $\partial\overline{B^2(0)}$ with $S^1 = \mathbb{R}/\mathbb{Z}$ via $e^{2\pi i\bar{\eta}} \leftrightarrow \bar{\eta}$, and define the standard coordinates $(\bar{\theta}, \bar{\eta})$ on $\partial(S^1 \times \overline{B^2(0)}) = S^1 \times \partial\overline{B^2(0)} = S^1 \times S^1$. Let $\lambda_1 := S^1 \times \{0\}$ and $\mu_1 := \{0\} \times S^1$ be the standard oriented longitude and meridian respectively. We identify these loops with the homology classes they represent, which form a basis of $H_1(\partial(S^1 \times \overline{B^2(0)})) \cong \mathbb{Z} \oplus \mathbb{Z}$. A similar canonical basis (λ_2, μ_2) of $H_1(\partial N_K)$ can be

chosen by requiring λ_2 to be the unique longitude of ∂N_K that is oriented in the same direction as K and is homologically trivial in $H_1(S^3 \setminus K) \cong \mathbb{Z}$. Then the isotopy class of ψ is entirely determined by the isomorphism $\psi_* : H_1(\partial(S^1 \times \overline{B^2(0)})) \rightarrow H_1(\partial N_K)$, which, in terms of the bases (λ_i, μ_i) , is represented by a matrix

$$\begin{pmatrix} n & q \\ m & p \end{pmatrix} \in \mathrm{GL}(2, \mathbb{Z}).$$

As it turns out, different surgeries produce diffeomorphic manifolds if the image of the meridian $\mu_1 \mapsto q\lambda_2 + p\mu_2$ is the same. One can prove this by constructing a diffeomorphism explicitly, using the fact that certain homeomorphisms of the boundary $\partial(S^1 \times \overline{B^2(0)})$ extend to homeomorphisms of the full solid torus. A more clever argument (see [Sa99]) would glue in the solid torus in two stages, beginning with a contractible segment around the meridian, then using the fact that every orientation preserving homeomorphism of S^2 is isotopic to the identity. In any case, we see that the numbers p and q determine the surgered manifold, and since $np - mq = \pm 1$ implies that these are relatively prime, the surgery can be described by the number $p/q \in \mathbb{Q} \cup \{\infty\}$, which we call the *framing*. The resulting manifold is independent of the choice of orientation for K , and we lose no generality in requiring ψ to preserve orientation (in which case the matrix of ψ_* is in $\mathrm{SL}(2, \mathbb{Z})$).

By a slight abuse of terminology, we refer to any identification of ∂N_K with $S^1 \times S^1$ as a *coordinate system* and call $(\theta, \eta) \in S^1 \times S^1$ *coordinates* on ∂N_K . Such coordinates will be called *canonical* if they generate the homology basis (λ_2, μ_2) in $H_1(\partial N_K)$. Then since all homeomorphisms of a torus that generate the same map on homology are isotopic, all surgeries can be obtained from gluing maps of the form

$$\psi(\bar{\theta}, \bar{\eta}) = \begin{pmatrix} \theta(\bar{\theta}, \bar{\eta}) \\ \eta(\bar{\theta}, \bar{\eta}) \end{pmatrix} = \begin{pmatrix} n & q \\ m & p \end{pmatrix} \begin{pmatrix} \bar{\theta} \\ \bar{\eta} \end{pmatrix}. \quad (2.1.1)$$

We shall always use gluing maps of this form.

A surgery with framing p/q is called *integral* if $q = \pm 1$, in which case we may as well assume $q = 1$ by appropriate choice of p . One can then interpret the framing as a linking number: the surgery identifies the meridian of $S^1 \times \overline{B^2(0)}$ with the homology class $\lambda_2 + r\mu_2$, whose linking number with K is p . Thus, roughly speaking, the framing p is equivalent to a choice of a loop parallel to K that winds around it p times. This loop is the unique longitude on ∂N_K that will become contractible in the surgered manifold.

One easily extends these notions from knots to links: a *framed link* in S^3 is a finite disjoint set of knots $\{K_j \subset S^3\}$, each given with a framing $r_j \in \mathbb{Q} \cup \{\infty\}$. Taking mutually disjoint tubular neighborhoods of the knots K_j , one then constructs a new manifold by surgery in each of these neighborhoods as described above. The surgery is called *integral* if all the framings are integers.

Theorem 2.1.1 (Lickorish [Li62], Wallace [Wa60]). *Every closed orientable 3-manifold can be obtained by integral Dehn surgery along some framed link in S^3 .*

This was used by Martinet [Ma71] to prove that every closed orientable 3-manifold admits a contact form. The construction is rather simple: start with the standard contact structure ξ_0 on S^3 , and let $K \subset S^3$ be an oriented framed knot. By a C^0 -small perturbation, we can assume K is *positively transverse* to ξ_0 , meaning that if $\gamma : S^1 \rightarrow S^3$ is an oriented parametrization of K and λ is a positive contact form with $\ker \lambda = \xi_0$, then $\lambda(\dot{\gamma}(t)) > 0$ for all $t \in S^1$. Then by the contact neighborhood theorem, one can identify a tubular neighborhood N_K of K with $S^1 \times B_\epsilon^2(0)$, where $B_\epsilon^2(0)$ is a ball around the origin in \mathbb{R}^2 , such that $K = S^1 \times \{0\}$ and ξ_0 is expressed in coordinates as the kernel of

$$\lambda_0 = d\theta + \rho^2 d\phi.$$

Here θ is the standard coordinate on S^1 and $(\rho, \phi) \in (0, \infty) \times (\mathbb{R}/2\pi\mathbb{Z})$ are polar coordinates on $B_\epsilon^2(0) \subset \mathbb{R}^2$; we can also choose this identification so that $(\theta, \eta) := (\theta, \phi/2\pi)$ define canonical coordinates on $\partial N_K \subset S^3$. Similarly, choose coordinates $(\bar{\theta}, \bar{\rho}, \bar{\phi})$ on the standard solid torus $S^1 \times B_\epsilon^2(0)$, and write $\bar{\eta} = \bar{\phi}/2\pi \in S^1$. Then we can perform surgery along K by cutting out K and attaching $S^1 \times B_\epsilon^2(0)$ via the embedding

$$\psi : S^1 \times (B_\epsilon^2(0) \setminus B_\delta^2(0)) \hookrightarrow S^3 \setminus K : (\bar{\theta}, \bar{\rho}, \bar{\phi}) \mapsto (\theta, \rho, \phi)$$

where $\rho = \bar{\rho}$, and (θ, ϕ) are determined by an invertible linear map

$$\begin{pmatrix} \theta \\ \eta \end{pmatrix} = \begin{pmatrix} n & q \\ m & p \end{pmatrix} \begin{pmatrix} \bar{\theta} \\ \bar{\eta} \end{pmatrix},$$

for some matrix in $\text{SL}(2, \mathbb{Z})$, with p/q dictated by the framing. Denoting the new manifold by M_K , we see that there is a contact form λ_K on $M_K \setminus (S^1 \times B_\delta^2(0))$ with $\ker \lambda_K = \xi_0$, so it remains to extend λ_K to the center of the solid torus. On $S^1 \times (B_\epsilon^2(0) \setminus B_\delta^2(0)) \subset M_K$, we can write

$$\begin{aligned} \lambda_K &= \psi^* \lambda_0 = \psi^*(d\theta + 2\pi\rho^2 d\eta) = d(n\bar{\theta} + q\bar{\eta}) + 2\pi\bar{\rho}^2 d(m\bar{\theta} + p\bar{\eta}) \\ &= (n + 2\pi\bar{\rho}^2 m)d\bar{\theta} + \left(\frac{q}{2\pi} + \bar{\rho}^2 p\right) d\bar{\phi}. \end{aligned}$$

Thus λ_K can be written in the form $f(\bar{\rho})d\bar{\theta} + g(\bar{\rho})d\bar{\phi}$ for some smooth real-valued functions f and g . We will have much more to say about 1-forms of this type, but for now it suffices to observe that such forms are positive contact forms for

$\bar{\rho} > 0$ if and only if the Wronskian $fg' - f'g$ is positive, which means that the curve $\bar{\rho} \mapsto (f(\bar{\rho}), g(\bar{\rho}))$ through \mathbb{R}^2 winds around the origin in the counterclockwise direction. One can define $(f(\bar{\rho}), g(\bar{\rho})) = (1, \bar{\rho}^2)$ or $(-1, -\bar{\rho}^2)$ for $\bar{\rho}$ close to 0, so that $f(\bar{\rho})d\bar{\theta} + g(\bar{\rho})d\bar{\phi}$ extends to $\bar{\rho} = 0$ as a contact form. In this way, λ_K can be extended over M_K as a contact form; see for instance Figure 2.2. Repeating this procedure for every connected component of a given framed link in S^3 , we obtain the existence result from [Ma71]:

Theorem 2.1.2 (Martinet). *Every closed oriented 3-manifold admits a positive contact form.*

Lutz twists

The existence result of Martinet can be improved substantially by supplementing Dehn surgeries with so-called *Lutz twists*, which alter the homotopy class of the contact structure while leaving the topology of the manifold unchanged. Let (M, ξ) be a contact 3-manifold with a positively transverse knot $K \subset M$. Then we can again choose coordinates (θ, ρ, ϕ) , identifying a neighborhood N_K of K with $S^1 \times B_\epsilon^2(0)$ such that $K = S^1 \times \{0\}$ and ξ is the kernel of $\lambda_0 = d\theta + \rho^2 d\phi$. Now define a new contact form $\lambda = f(\rho)d\theta + g(\rho)d\phi$ such that

- (i) $(f(\rho), g(\rho)) = (1, \rho^2)$ for ρ larger than some number $\delta \in (0, \epsilon)$, and
- (ii) If $\alpha(\rho)$ is the angular coordinate of the point $(f(\rho), g(\rho))$ in polar coordinates on \mathbb{R}^2 , then α is an increasing function with $\alpha(0) = -\pi$ and $\alpha(\rho) \in (0, \pi/2)$ for $\rho \geq \delta$ (Figure 2.3).

Again we can make sure that λ is a smooth contact form at $\rho = 0$ by setting $(f(\rho), g(\rho)) = (-1, -\rho^2)$ for ρ near 0. The new contact structure matches the old one outside a neighborhood of N_K , and we shall refer to this particular type of modification as a *half-Lutz twist*. Similarly, a *full-Lutz twist* would have $\alpha(0) = -2\pi$ (Figure 2.4). A full-Lutz twist is less interesting for our purposes though, as it produces a new contact structure which is homotopic to the old one through two-plane distributions (Bennequin [Be83] gives an explicit homotopy). The half-Lutz twist, on the other hand, does change the homotopy class of ξ , and so does an $\frac{n}{2}$ -Lutz twist whenever n is odd.

It turns out that half-Lutz twists can be used to change a given contact structure ξ on M to a new contact structure ξ_K which is homotopic to *any* prescribed cooriented 2-plane distribution α . Lutz proved this for S^3 in his thesis [Lu71], and the result can be extended to all closed oriented 3-manifolds by an obstruction theory

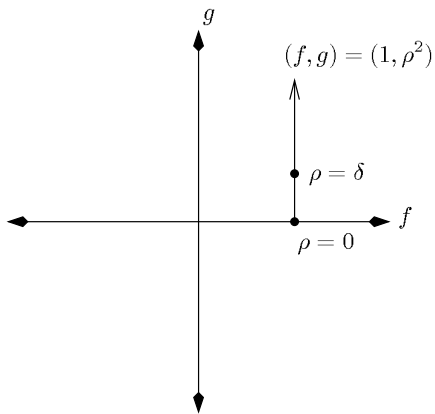

Figure 2.1: The trajectory $\rho \mapsto (f(\rho), g(\rho))$ for the contact structure $\lambda_0 = f(\rho)d\theta + g(\rho)d\phi = d\theta + \rho^2 d\phi$

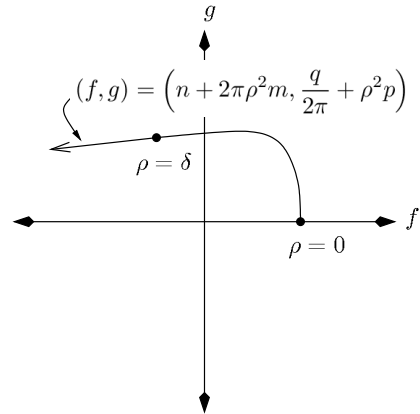

Figure 2.2: Modification of λ_0 under nontrivial Dehn surgery

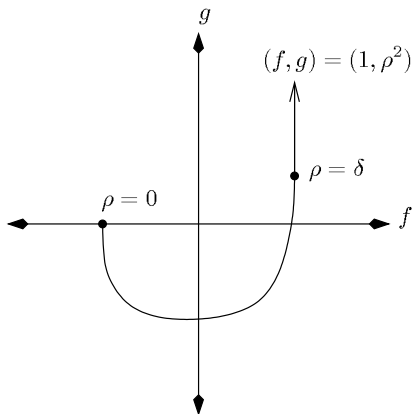

Figure 2.3: Half-Lutz twist of λ_0

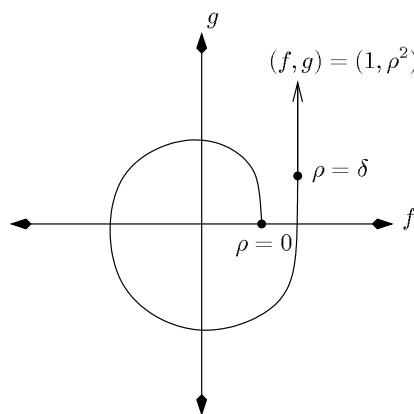

Figure 2.4: Full-Lutz twist of λ_0

argument. In brief, one can define obstruction classes

$$\begin{aligned} d^2(\alpha, \xi) &\in H^2(M; \pi_2(S^2)) \cong H^2(M; \mathbb{Z}) \\ d^3(\alpha, \xi) &\in H^3(M; \pi_3(S^2)) \cong H^3(M; \mathbb{Z}) \cong \mathbb{Z} \end{aligned}$$

which measure whether two distributions α and ξ are homotopic over the 2-skeleton and 3-skeleton respectively. Then one proves that the modification $\xi \rightarrow \xi_K$ can be used to change both of these classes to any desired value, so long as one allows sufficiently arbitrary homology classes and self-linking numbers for the transverse link $K \subset M$. A detailed account of this argument may be found in [Ge03].

The Lutz-Martinet result can be summarized using the concept of a *partially framed link*. We define this to be an oriented link $K \subset S^3$ with integer framings associated to *some* (but not necessarily all) of its components; these integers constitute a *partial framing* of K . There is a unique closed cooriented contact manifold (M_K, ξ_K) associated to every partially framed link $K \subset S^3$ in the following way: after perturbing K to be positively transverse to the standard contact structure ξ_0 on S^3 , we can perform Dehn surgery on each component for which a framing is given, and modify ξ_0 as described above, producing the manifold M_K with some contact structure ξ . (One must settle on a convention for how to extend ξ_0 to $S^1 \times \{0\}$ in each new solid torus; here there are choices to be made, but they aren't important for the present discussion.) Then for each remaining component of K we perform a half-Lutz twist, changing ξ to ξ_K .

Theorem 2.1.3 (Lutz, Martinet). *Given a closed oriented 3-manifold M with a cooriented 2-plane distribution α , there exists a partially framed link $K \subset S^3$ such that $M_K = M$ and the distribution ξ_K is homotopic to α .*

Note that the contact manifold (M_K, ξ_K) produced in this way is usually overtwisted, and in fact the classification result of Eliashberg [E89] shows that this procedure produces *every* overtwisted contact structure up to isomorphism.

Remark 2.1.4. *For the sake of later constructions, it will help to know that we can assume our contact structure is always overtwisted. Indeed, the Martinet construction of ξ on M_K allows considerable freedom in the way that we extend ξ_0 to the center of each solid torus being glued in; in particular we can choose to replace the trajectory $\rho \mapsto (f(\rho), g(\rho))$ of Figure 2.2 with one that winds an extra time around the origin. This may change the homotopy class of ξ , but we can use Lutz twists along other knots to change it back.*

We can therefore assume without loss of generality that we have a contact structure ξ' on M , homotopic to α , constructed from (S^3, ξ_0) by Dehn surgery and Lutz twists along a transverse link $K \subset S^3$, and having the following additional property.

Near each connected component $K_j \subset K \subset S^3$, we have chosen canonical coordinates (θ, ρ, ϕ) , which are also valid coordinates on an open subset of M for ρ larger than some small number δ : then in this subset, ξ' is the kernel of

$$f(\rho)d\theta + g(\rho)d\phi$$

for some smooth functions f and g , and there is a radius ρ_0 at which $g(\rho_0) < 0$ and $g'(\rho_0) = 0$. In other words, outside of this radius ρ_0 , the new contact structure looks just like a half-Lutz twist of ξ_0 along $K_j \subset S^3$. We will use this fact in Chapter 5 to facilitate the construction of a finite energy foliation in the region outside of these open subsets.

2.2 Transverse links are almost Hopf circles

For technical reasons, it will be useful later on to assume that the transverse links where we do surgery are “close” to a particular loop in S^3 , one which is a periodic orbit for the standard contact form. The goal of this section is to prove that we can make such an assumption without loss of generality.

Lemma 2.2.1. *Let $K \subset S^3$ be a link positively transverse to the standard contact structure ξ_0 , and let P be an oriented Hopf circle. Then K is transversally isotopic to a link whose components are each C^∞ -close to a positive cover of P . To be precise, if P is parametrized by an embedding $x : S^1 \rightarrow S^3$, then for each component $K_j \subset K$ there is a smooth immersion $F_j : [0, 1] \times S^1 \rightarrow S^3$ such that $F_j(1, \cdot) : S^1 \rightarrow S^3$ parametrizes K_j , $F_j(0, t) = x(k_j t)$ for some $k_j \in \mathbb{N}$, and for all fixed $\tau \in (0, 1]$, the maps $F_j(\tau, \cdot) : S^1 \rightarrow S^3$ are mutually non-intersecting embeddings transverse to ξ_0 .*

A version of this was stated as Theorem 10 in [Be83], but without explicit proof. It follows from a similar result for \mathbb{R}^3 which is proved earlier in the same paper (Theorem 8). To set the stage, define a contact structure ζ_0 on \mathbb{R}^3 in cylindrical coordinates (ρ, ϕ, z) as the kernel of $dz + \rho^2 d\phi$. This is isomorphic to the standard contact form $dz + xdy$. (The proof of this fact is a diverting exercise in Moser’s deformation technique!)

Theorem 2.2.2 (Bennequin [Be83]). *Let $K \subset \mathbb{R}^3$ be a link positively transverse to ζ_0 . Then K is transversally isotopic to a closed braid around the z -axis; that is, a link in which every component can be parametrized as $(\rho(t), \phi(t), z(t))$ with $\rho(t) > 0$ and $\dot{\phi}(t) > 0$ for all $t \in S^1$.*

Proof of Lemma 2.2.1. As usual, identify S^3 with the unit sphere in \mathbb{C}^2 . There are contactomorphisms taking any Hopf circle to any other Hopf circle (e.g. 2-by-2

unitary matrices), thus we may assume $P = \{(e^{2\pi i\theta}, 0) \mid \theta \in S^1\}$. Identify \mathbb{R}^3 with $\mathbb{C} \times \mathbb{R} \subset \mathbb{C}^2$, using (ρ, ϕ) as polar coordinates on \mathbb{C} and z as the coordinate on the \mathbb{R} factor. Let $p = (0, -1) \in \mathbb{C}^2$ and define

$$\varphi : S^3 \setminus \{p\} \rightarrow \mathbb{R}^3 : (z_1, z_2) \mapsto \left(\frac{z_1}{1 + z_2}, -\frac{i(z_2 - \bar{z}_2)}{2|1 + z_2|^2} \right).$$

This is a contactomorphism $(S^3 \setminus \{p\}, \xi_0) \rightarrow (\mathbb{R}^3, \zeta_0)$; see [Ge03], Sec. 2.1. We can perturb K if necessary so that $p \notin K$ and then reduce the problem to the following question: is there a transverse isotopy of the link $\varphi(K) \subset \mathbb{R}^3$, bringing it close to the loop $\varphi(P) = \{(e^{2\pi i\theta}, 0) \mid \theta \in S^1\} \subset \mathbb{R}^3$?

Let us now change notation and assume K is a positively transverse link in (\mathbb{R}^3, ζ_0) and $P = \{(e^{2\pi i\theta}, 0) \mid \theta \in S^1\} \subset \mathbb{R}^3$. From Theorem 2.2.2 we can assume after transverse isotopy that K is a closed braid about the z -axis. Thus we can parametrize the components of K by non-intersecting embeddings $\gamma_1, \dots, \gamma_N : S^1 \rightarrow \mathbb{R}^3$, which appear in the (ρ, ϕ, z) -coordinates as

$$\gamma_j(t) = (\rho_j(t), 2\pi n_j t, z_j(t)) \quad \text{for some } n_j \in \mathbb{N}.$$

A knot of this form is positively transverse to ζ_0 if and only if $[\rho_j(t)]^2 > -\frac{\dot{z}_j(t)}{2\pi n_j}$. Now let

$$\tau_0 = \frac{2\pi n_j}{\max_{j,t} |\dot{z}_j(t)|}$$

if the functions $z_j(t)$ are not all constant; else set $\tau_0 = 1$. Choose a smooth nondecreasing function $\beta : [0, 1] \rightarrow [0, 1]$ with $\beta(0) = 0$, $\beta'(0) > 0$, $\beta(1) = 1$, and $\beta(\tau) = 1$ for all $\tau \in [\tau_0, 1]$ if $\tau_0 < 1$. Now consider a homotopy of the form

$$\gamma_j^\tau(t) = (\beta(\tau)\rho_j(t) + (1 - \beta(\tau)), 2\pi n_j t, \tau z_j(t)) \quad \text{for } \tau \in [0, 1].$$

This defines an isotopy of K for $\tau \in (0, 1]$, and γ_j^0 is an n_j -fold cover of P . To verify that it's a *transverse* isotopy, we must check that

$$[\beta(\tau)\rho_j(t) + (1 - \beta(\tau))]^2 > -\frac{\tau \dot{z}_j(t)}{2\pi n_j}, \quad (2.2.1)$$

for all $t \in S^1$ and $\tau \in (0, 1]$. This is trivial whenever $\dot{z}_j(t) \geq 0$, so assume $\dot{z}_j(t) < 0$ for some t . If $\tau \geq \tau_0$, the left hand side of (2.2.1) is simply $[\rho_j(t)]^2$, and since γ_j^1 is transverse, $[\rho_j(t)]^2 > \frac{-\dot{z}_j(t)}{2\pi n_j} \geq \tau \frac{-\dot{z}_j(t)}{2\pi n_j}$. For $\tau < \tau_0$, we observe that $\beta(\tau)\rho_j(t) + (1 - \beta(\tau))$ is an interpolation between $\rho_j(t)$ and 1, so this number is either greater

than $\rho_j(t)$ or greater than 1. In the former case, we again use the fact that γ_j^1 is transverse to conclude that (2.2.1) holds. In the latter case, we have

$$\begin{aligned} [\beta(\tau)\rho_j(t) + (1 - \beta(\tau))]^2 \geq 1 &\geq \left(\frac{2\pi n_j}{\max_{j,t} |\dot{z}_j(t)|} \right) \frac{|\dot{z}_j(t)|}{2\pi n_j} \\ &= \tau_0 \frac{|\dot{z}_j(t)|}{2\pi n_j} > \tau \frac{-\dot{z}_j(t)}{2\pi n_j}. \end{aligned}$$

Using the contactomorphism φ^{-1} , this result transfers back to (S^3, ξ_0) , proving the lemma. \square

Chapter 3

Explicit Constructions of Foliations

By the Lutz-Martinet theorem, all of the contact manifolds in which we are interested can be constructed from the tight 3-sphere (S^3, ξ_0) by surgery along partially framed links $K \subset S^3$. This produces a new manifold (M, ξ) , which contains a link $K' \subset M$ such that there are tubular neighborhoods $K \subset N_K \subset S^3$ and $K' \subset N_{K'} \subset M$ with

$$(S^3 \setminus N_K, \xi_0) \cong (M \setminus N_{K'}, \xi).$$

The construction of a finite energy foliation on (M, ξ) will be done in two stages, with separate families of holomorphic curves filling the the regions $N_{K'}$ and $M \setminus N_{K'}$. In this chapter we solve the problem for the neighborhood $N_{K'}$, by choosing a Morse-Bott contact form with enough symmetry so that the Cauchy-Riemann equations can be solved, more or less explicitly. This is the task of Sec. 3.1, which will fit together with the work of Chapters 4 and 5 to prove the main existence result. In Sec. 3.2, we extend the local analysis to address the problem of continuing a given foliation from outside of $N_{K'}$ to the inside. This only works under some restrictive assumptions and is not sufficient to prove the main result, but it does allow a construction of foliations for which J becomes singular at K' ; this will turn out to be useful for a technical argument in Chapter 5. Finally Sec. 3.3, which will not be used elsewhere except in the speculative discussions of Chapter 6, shows how the Morse-Bott construction on $N_{K'}$ can be perturbed to a stable foliation with nondegenerate data.

3.1 Morse-Bott contact structures in $S^1 \times \mathbb{R}^2$

We now investigate the following situation as a model of a contact manifold in the neighborhood of some periodic orbit of the Reeb vector field. In particular, we have in mind the neighborhood $N_{K'} = S^1 \times B_\epsilon^2(0)$ of a knot $K' = S^1 \times \{0\}$ that is glued into $S^3 \setminus N_K$.

Let $M = S^1 \times \mathbb{R}^2$. Denote by (ρ, ϕ) polar coordinates on the \mathbb{R}^2 factor, with corresponding Cartesian coordinates $(x, y) = (\rho \cos \phi, \rho \sin \phi)$, and let θ be the coordinate on $S^1 = \mathbb{R}/\mathbb{Z}$. Assume M is oriented so that at each point the basis $\left(\frac{\partial}{\partial \theta}, \frac{\partial}{\partial \rho}, \frac{\partial}{\partial \phi}\right)$ is positive. We can define a 1-form by

$$\lambda = f(\rho)d\theta + g(\rho)d\phi,$$

where the functions f and g are defined for $\rho \geq 0$ and chosen so that $(\rho, \phi) \mapsto f(\rho)$ and $(\rho, \phi) \mapsto g(\rho)/\rho^2$ define smooth functions on \mathbb{R}^2 . This implies, among other things, that $f'(0) = g'(0) = g(0) = 0$. Then λ is a smooth 1-form on M and is also a positive contact form if we make the following assumptions:

- (i) The Wronskian $D(\rho) := f(\rho)g'(\rho) - f'(\rho)g(\rho) > 0$ for all $\rho > 0$.
- (ii) $f(0)g''(0) > 0$.

Indeed, a simple calculation shows that

$$\lambda \wedge d\lambda = D(\rho)d\theta \wedge d\rho \wedge d\phi = \frac{D(\rho)}{\rho}d\theta \wedge dx \wedge dy,$$

and $\lim_{\rho \rightarrow 0} D(\rho)/\rho = D'(0) = f(0)g''(0)$. Intuitively, these conditions mean that the curve $\rho \mapsto (f(\rho), g(\rho))$ always winds counterclockwise around the origin in the xy -plane, beginning on the x -axis with zero velocity and nonzero angular acceleration. We will impose additional conditions on f and g as the need arises.

Denote by $\xi = \ker \lambda$ the contact structure on (M, λ) . The Reeb vector field X_λ satisfies $d\lambda(X_\lambda, \cdot) = 0$ and $\lambda(X_\lambda) = 1$, which imply

$$X_\lambda(\theta, \rho, \phi) = \frac{1}{D(\rho)} \left(g'(\rho) \frac{\partial}{\partial \theta} - f'(\rho) \frac{\partial}{\partial \phi} \right). \quad (3.1.1)$$

A general orbit of the Reeb vector field is then of the form

$$x(t) = (\theta(t), \rho(t), \phi(t)) = \left(\theta_0 + \frac{g'(r)}{D(r)}t, r, \phi_0 - \frac{f'(r)}{D(r)}t \right),$$

given fixed constants θ_0 , r and ϕ_0 , and we see that for $r > 0$, the orbit is periodic whenever $\frac{f'(r)}{2\pi g'(r)} = \frac{p}{q} \in \mathbb{Q} \cup \{\infty\}$. Here we take p and q to be relatively prime integers with signs chosen to match those of $f'(r)$ and $g'(r)$ respectively; the minimal period is then

$$T = q \frac{D(r)}{g'(r)} = 2\pi p \frac{D(r)}{f'(r)} \quad (3.1.2)$$

(in the cases where $f'(r) = p = 0$ or $g'(r) = q = 0$, pick whichever one of these expressions makes sense). Thus the torus $L_r := \{\rho = r\} \subset M$ is foliated by periodic orbits whenever $f'(r)/2\pi g'(r)$ is rational or $g'(r) = 0$.

Recall that a closed submanifold $L \subset M$ foliated by periodic orbits of the same minimal period T is called a *simple Morse-Bott manifold* if for every $x \in L$ and $k \in \mathbb{N}$, $T_x L = \{v \in T_x M \mid d\varphi^{kT}(x)v = v\}$, where Φ^t is the time- t flow of X_λ . For the torus L_r , this would amount to the statement that $\frac{\partial}{\partial \rho}$ is never an eigenvector of $d\Phi^{kT}$ with eigenvalue 1. From the expression

$$\Phi^{kT}(\theta, \rho, \phi) = \left(\theta + \frac{g'(\rho)}{D(\rho)} kT, \rho, \phi - \frac{f'(\rho)}{D(\rho)} kT \right), \quad (3.1.3)$$

we compute

$$\frac{\partial \Phi^{kT}}{\partial \rho}(\theta, r, \phi) = \frac{\partial}{\partial \rho} + (f''g' - f'g'')kT \left(\frac{g}{D^2} \frac{\partial}{\partial \theta} - \frac{f}{D^2} \frac{\partial}{\partial \phi} \right),$$

where all functions are evaluated at r . The condition $D > 0$ implies that f and g are never both 0, so the desired result is obtained if and only if $f''g' - f'g'' \neq 0$, which is equivalent to the statement that the slope g'/f' of the curve $\rho \mapsto (f(\rho), g(\rho))$ (or the slope's reciprocal, if $f'(r) = 0$) has nonzero derivative at r . We've proved:

Proposition 3.1.1. *If $f'(r)/2\pi g'(r) = p/q \in \mathbb{Q} \cup \{\infty\}$ and the function $\rho \mapsto f'(\rho)/g'(\rho)$ (or its reciprocal) has nonvanishing derivative at r , then the torus $L_r = \{\rho = r\} \subset M$ is a simple Morse-Bott manifold of periodic orbits, with minimal period given by (3.1.2).*

At $\rho = 0$ we have $X_\lambda(\theta, 0, 0) = \frac{1}{f'(0)} \frac{\partial}{\partial \theta}$, thus the circle $P := \{\rho = 0\} \subset M$ is also a periodic orbit, with period $T = |f(0)|$. For $k \in \mathbb{N}$, denote by P^k the k -fold cover of P , with period kT .

Proposition 3.1.2. *The circle $P = \{\rho = 0\} \subset M$ is a periodic orbit with period $T = |f(0)|$. Its k -fold cover P^k is degenerate if and only if*

$$\frac{k f''(0)}{2\pi g''(0)} \in \mathbb{Z},$$

and otherwise has Conley-Zehnder index

$$\mu_{CZ}(P^k) = 2 \left\lfloor -\frac{kf''(0)}{2\pi g''(0)} \right\rfloor + 1$$

with respect to the natural symplectic trivialization of ξ along P induced by the coordinates. Here $\lfloor x \rfloor$ represents the greatest integer $\leq x$.

The proof is a routine computation. The moral is that the nondegeneracy and index of any cover of P depends on the slope of the trajectory $\rho \mapsto (f(\rho), g(\rho))$ as it pushes off from the x -axis at $\rho = 0$. So by choosing f and g of the form

$$(f(\rho), g(\rho)) = (\pm 1 + \alpha\rho^2, \pm\rho^2) \quad \text{for } \rho \text{ near } 0$$

with $\alpha \in \mathbb{R}$, we can arrange any desired odd value for $\mu_{CZ}(P^k)$.

The goal is to construct various finite energy foliations in a neighborhood of $P \subset M$. We must first pick a suitable complex structure $J : \xi \rightarrow \xi$. Define a pair of vector fields on $M \setminus P$ by

$$v_1 = \frac{\partial}{\partial \rho}, \quad v_2 = \frac{1}{D} \left(-g \frac{\partial}{\partial \theta} + f \frac{\partial}{\partial \phi} \right). \quad (3.1.4)$$

These vectors form a basis of ξ on $M \setminus P$, with $d\lambda(v_1, v_2) \equiv 1$, and we can use them to define an admissible complex multiplication by

$$Jv_1 = \beta(\rho)v_2, \quad Jv_2 = -\frac{1}{\beta(\rho)}v_1 \quad (3.1.5)$$

for some smooth function $\beta(\rho)$. The behavior of β near 0 can be chosen to ensure that J is smooth at $\rho = 0$. We now define \tilde{J} as the standard \mathbb{R} -invariant almost complex structure on $\mathbb{R} \times M$ determined by λ and J . Then we seek maps $\tilde{u} : (S, j) \rightarrow (\mathbb{R} \times M, \tilde{J})$ defined on a Riemann surface (S, j) and satisfying $T\tilde{u} \circ j = \tilde{J} \circ T\tilde{u}$. In conformal coordinates (s, t) on S , this is equivalent to $\tilde{u}_s + \tilde{J}(\tilde{u})\tilde{u}_t = 0$, or, writing $\tilde{u} = (a, u)$, the three equations

$$\begin{aligned} a_s - \lambda(u_t) &= 0 \\ a_t + \lambda(u_s) &= 0 \\ \pi_\lambda u_s + J\pi_\lambda u_t &= 0 \end{aligned} \quad (3.1.6)$$

where $\pi_\lambda : TM \rightarrow \xi$ is the projection along X_λ onto the contact structure. The map u can be written in coordinates as $u(s, t) = (\theta(s, t), \rho(s, t), \phi(s, t))$, and then

the equations (3.1.6) become

$$\begin{aligned} a_s &= f\theta_t + g\phi_t & \rho_s &= \frac{1}{\beta}(f'\theta_t + g'\phi_t) \\ a_t &= -f\theta_s - g\phi_s & \rho_t &= -\frac{1}{\beta}(f'\theta_s + g'\phi_s) \end{aligned} \quad (3.1.7)$$

It seems reasonable that given two concentric tori $L_{\pm} = \{\rho = \rho_{\pm}\}$, each foliated by periodic orbits that are homologous in $H_1(M \setminus P)$, one might be able to find a finite energy foliation of the region between them, each leaf being a finite energy cylinder with ends asymptotic to orbits at L_- and L_+ respectively (Figure 3.1). Indeed, suppose there are two radii ρ_{\pm} with $0 < \rho_- < \rho_+$, such that the following conditions are met:

- (i) $\frac{f'(\rho_{\pm})}{2\pi g'(\rho_{\pm})} = \frac{p}{q} \in \mathbb{Q} \cup \{\infty\}$
- (ii) $\frac{f'(\rho)}{2\pi g'(\rho)} \neq \frac{p}{q}$ for $\rho \in (\rho_-, \rho_+)$

A choice of sign must be made for p and q : for reasons that will become clear shortly, let us choose p and q such that the quantity $qf'(\rho) - 2\pi pg'(\rho)$ is positive for $\rho \in (\rho_-, \rho_+)$. The two tori L_{\pm} are each foliated by families of periodic orbits, of the form

$$x_{\pm}(t) = \left(\theta_0 + \frac{q_{\pm}}{T_{\pm}}t, \rho_{\pm}, \phi_0 - \frac{2\pi p_{\pm}}{T_{\pm}}t \right).$$

Here p_{\pm} and q_{\pm} are the same as p and q up to a sign, which must be chosen so that the periods $T_{\pm} = \frac{q_{\pm}D(\rho_{\pm})}{g'(\rho_{\pm})} = \frac{2\pi p_{\pm}D(\rho_{\pm})}{f'(\rho_{\pm})}$ are positive. Fixing values of θ_0 and ϕ_0 , we aim to find a finite energy cylinder $\tilde{u} = (a, u) : \mathbb{R} \times S^1 \rightarrow \mathbb{R} \times M$ that is asymptotic at one end to x_+ , and at the other to x_- , i.e.

$$\lim_{s \rightarrow \pm\infty} u(s, t) = x_{\pm}(T_{\pm}t) \text{ or } x_{\pm}(-T_{\pm}t). \quad (3.1.8)$$

Optimistically, such a map might take the form

$$(a(s, t), \theta(s, t), \rho(s, t), \phi(s, t)) = (a(s), \theta_0 + qt, \rho(s), \phi_0 - 2\pi pt). \quad (3.1.9)$$

Taking this as an ansatz, we find that (3.1.7) reduces to the pair of ordinary differential equations

$$\frac{d\rho}{ds} = \frac{1}{\beta(\rho)}(qf'(\rho) - 2\pi pg'(\rho)), \quad (3.1.10a)$$

$$\frac{da}{ds} = qf(\rho) - 2\pi pg(\rho). \quad (3.1.10b)$$

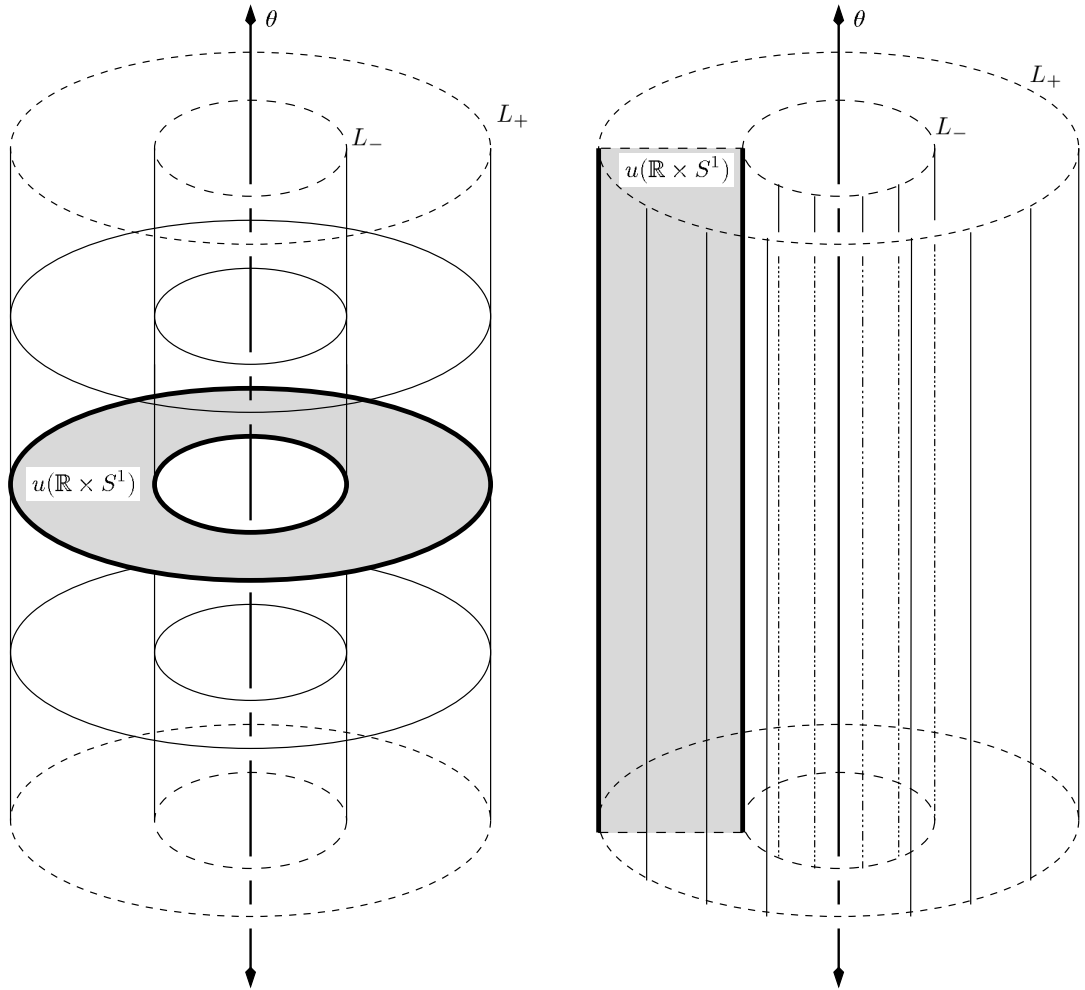

Figure 3.1: Concentric tori with homologous periodic orbits connected by a finite energy cylinder. On the left is the case where $g'(\rho_\pm) = 0$, so the orbits are parallel to ∂_ϕ . On the right, $f'(\rho_\pm) = 0$ gives orbits parallel to ∂_θ .

These have unique solutions for any choice of $\rho(0) \in (\rho_-, \rho_+)$ and $a(0) \in \mathbb{R}$. Notice that due to our sign convention for p and q , the right hand side of (3.1.10a) is always positive, thus $\lim_{s \rightarrow \pm\infty} \rho(s) = \rho_{\pm}$ as desired. It is then clear that $u(s, \cdot)$ converges in the C^1 -topology to a periodic orbit as $s \rightarrow \pm\infty$, and we conclude from Prop. A.3.1 that \tilde{u} is a finite energy cylinder, with energy bounded by $T_+ + T_-$. For future convenience we shall refer to this curve as a *cylinder of type* (p, q) . An example is shown in Figure 3.3.¹

It is clear from (3.1.10b) that a is a proper function with asymptotically linear growth to $\pm\infty$, as the condition $D(\rho) > 0$ guarantees that $\lim_{s \rightarrow \pm\infty} a'(s) = qf(\rho_{\pm}) - 2\pi pg(\rho_{\pm})$ cannot be zero. This expression determines the sign of the puncture at $s = \pm\infty$ by

$$\text{sign of puncture at } L_{\pm} = \pm \text{sgn}(qf(\rho_{\pm}) - 2\pi pg(\rho_{\pm})). \quad (3.1.11)$$

To put this in a more revealing form, write $f_{\pm} := f(\rho_{\pm})$, $f'_{\pm} := f'(\rho_{\pm})$ etc., and observe that by assumption there is a nonzero number

$$c_{\pm} = \frac{2\pi p}{f'_{\pm}} = \frac{q}{g'_{\pm}}.$$

Then (3.1.11) becomes $\pm \text{sgn}[c_{\pm}(f_{\pm}g'_{\pm} - f'_{\pm}g_{\pm})] = \pm \text{sgn}(c_{\pm})$ since $D(\rho_{\pm})$ is positive. Now if both tori L_{\pm} satisfy the Morse-Bott condition of Prop. 3.1.1, then $0 \neq f'_{\pm}g''_{\pm} - f''_{\pm}g'_{\pm} = -\frac{1}{c_{\pm}}(qf''_{\pm} - 2\pi pg''_{\pm})$, and our sign convention for p and q implies $\text{sgn}(qf''_{\pm} - 2\pi pg''_{\pm}) = \mp 1$, thus

$$\text{sgn}(f'_{\pm}g''_{\pm} - f''_{\pm}g'_{\pm}) = -\text{sgn}(c_{\pm}) \text{sgn}(qf''_{\pm} - 2\pi pg''_{\pm}) = \pm \text{sgn}(c_{\pm}),$$

which is the sign of the puncture at L_{\pm} . This expression depends only on the contact form, and it has a geometric interpretation in terms of the acceleration of the trajectory $\rho \mapsto (f(\rho), g(\rho))$.

Definition 3.1.3. *If $L_r = \{\rho = r\}$ is a simple Morse-Bott torus, then we call it positive or negative in accordance with the sign of $f'(r)g''(r) - f''(r)g'(r)$.*

Proposition 3.1.4. *Suppose $\tilde{u} : \mathbb{R} \times S^1 \rightarrow \mathbb{R} \times M$ is a cylinder of type (p, q) with an asymptotic limit on some simple Morse-Bott torus L_r at one of its punctures. Then the sign of this puncture matches the sign of L_r .*

So L_r is a positive Morse-Bott torus if the trajectory $\rho \mapsto (f(\rho), g(\rho))$ accelerates inward at $\rho = r$, negative if the acceleration is outward. Observe that there can

¹Thanks to Joel Fish for providing Figures 3.3 and 3.4.

never be two consecutive negative tori with homologous periodic orbits—as one would expect since a finite energy cylinder must have at least one positive puncture. We will see in Sec. 4.2.3 that the behavior of Prop. 3.1.4 is quite general.

The equations (3.1.10) can be thought of as defining a direction field in the subset $(\rho_-, \rho_+) \times \mathbb{R}$ of the ρa -plane, which integrates to a one-dimensional foliation. Since (3.1.10b) defines $a(s)$ only up to a constant, this foliation is invariant under the natural \mathbb{R} -action on the a -coordinate. Meanwhile the set of trajectories $t \mapsto (\theta_0 + qt, \phi_0 - 2\pi pt) \in S^1 \times \mathbb{R}/2\pi\mathbb{Z}$ for all choices of θ_0 and ϕ_0 defines another one-dimensional foliation. Putting these together as in (3.1.9) creates a two-dimensional foliation of the region $\{(a, \theta, \rho, \phi) \in \mathbb{R} \times M \mid \rho \in (\rho_-, \rho_+)\}$ by finite energy cylinders. Note that the maps $u = (\theta, \rho, \phi) : S^1 \times \mathbb{R} \rightarrow M$ are also embeddings. The foliation can be extended to $\rho = \rho_{\pm}$ by adding the cylinders over periodic orbits at L_{\pm} . Moreover, if there exists a radius $\rho_0 \in (0, \rho_-)$ such that ρ_0 and ρ_- satisfy the same conditions as ρ_- and ρ_+ , then we can repeat this construction for $\rho \in (\rho_0, \rho_-)$ and thus extend the foliation to the region $\rho \in [\rho_0, \rho_+]$.

It remains to extend the foliation further toward the center in the case where there is no $\rho < \rho_-$ with $f'(\rho)/2\pi g'(\rho) = p/q$. To that end, let us redefine our notation with $\rho_- = 0$ and $L_+ = \{\rho = \rho_+\}$; choose $\rho_+ > 0$ so that:

- (i) $\frac{f'(\rho_+)}{2\pi g'(\rho_+)} = \frac{p}{q} \in \mathbb{Q} \cup \{\infty\}$
- (ii) $\frac{f'(\rho)}{2\pi g'(\rho)} \neq \frac{p}{q}$ for $\rho \in (0, \rho_+)$

Choose the signs of p and q so that $qf' - 2\pi pg' > 0$ for $\rho \in (0, \rho_+)$, and consider once more the family of \tilde{J} -holomorphic cylinders defined by

$$\tilde{u} = (a, u) : \mathbb{R} \times S^1 \rightarrow \mathbb{R} \times M : (s, t) \mapsto (a(s), \theta_0 + qt, \rho(s), \phi_0 - 2\pi pt),$$

where $\rho(s)$ and $a(s)$ satisfy the ODEs (3.1.10) with $\rho(0) \in (0, \rho_+)$. By the same arguments as before, $u(s, \cdot)$ converges in the C^1 -topology (up to parametrization) as $s \rightarrow \infty$ to the periodic orbit

$$x_+(t) = \left(\theta_0 + \frac{q_+}{T_+}t, \rho_+, \phi_0 - \frac{2\pi p_+}{T_+}t \right) \in L_+.$$

Define $F(\rho)$ to be the right hand side of (3.1.10a). The requirement that J be smooth at $\rho = 0$ implies that $\beta(\rho)$ is bounded away from zero as $\rho \rightarrow 0$, thus $\lim_{\rho \rightarrow 0} F(\rho) = 0$, and we conclude that $\rho(s) \rightarrow 0$ as $s \rightarrow -\infty$.

We must now distinguish between two cases in order to understand fully the behavior as $s \rightarrow -\infty$. If $q \neq 0$, $u(s, \cdot)$ is C^1 -convergent to the $|q|$ -fold cover of P ,

with the sign of the puncture opposite the sign of q . In that case we have a family of finite energy cylinders, each convergent to $P^{|q|}$ at one end and a simply covered orbit on L_+ at the other. By the same arguments as before, these together with the orbit cylinder over P form a finite energy foliation in the region $\rho < \rho_+$. Figure 3.2, right, shows an example with $(p, q) = (0, 1)$. An example with p and q both nonzero is shown in Figure 3.4.

If $q = 0$, we have $\lim_{s \rightarrow -\infty} u(s, t) = (\theta_0, 0) \in P \subset S^1 \times \mathbb{R}^2$. In fact, since

$$\lim_{\rho \rightarrow 0} F'(\rho) = -\frac{2\pi p g''(0)}{\lim_{\rho \rightarrow 0} \beta(\rho)} \neq 0,$$

one can easily show that $\rho(s)$ converges exponentially fast to 0, and plugging this behavior into the equation $\rho' = F(\rho)$, so does its derivative. We now claim that $a(s)$ is bounded at $-\infty$. For this it suffices to prove that the integral

$$\int_{-\infty}^0 \frac{da}{ds} ds = -2\pi p \int_{-\infty}^0 g(\rho(s)) ds$$

converges. We know $\rho'(s)$ satisfies a bound of the form $|\rho'(s)| \leq M e^{\lambda s}$ with $\lambda > 0$. Since g' is continuous and ρ stays within a bounded interval for all s , we have

$$\begin{aligned} |g(\rho(s))| &= \left| \int_{-\infty}^s \frac{d}{d\sigma} g(\rho(\sigma)) d\sigma \right| \leq \int_{-\infty}^s |g'(\rho(\sigma))| |\rho'(\sigma)| d\sigma \\ &\leq M_1 \int_{-\infty}^s e^{\lambda\sigma} d\sigma = M_2 e^{\lambda s} \end{aligned}$$

for some constant $M_2 > 0$. Clearly then $\int_{-\infty}^0 |g(\rho(s))| ds < \infty$ and the claim follows. Since $u_t(s, \cdot)$ converges uniformly to 0 as $s \rightarrow -\infty$, a simple application of Stokes' theorem now shows that for any function $\varphi \in C^\infty(\mathbb{R})$ with $\varphi' > 0$, the energy

$$\int_{(-\infty, 0] \times S^1} \tilde{u}^* d(\varphi\lambda)$$

is finite. Thus Gromov's removable singularity theorem applies, and \tilde{u} can be extended to a finite energy plane $\tilde{v} = (b, v) : \mathbb{C} \rightarrow \mathbb{R} \times M$ with $\tilde{v}(e^{2\pi(s+it)}) = \tilde{u}(s, t)$ and $v(0) = (\theta_0, 0) \in S^1 \times \mathbb{R}^2$. The set of all such planes then forms a two-dimensional foliation of the interior of the solid torus, $\{\rho < \rho_+\}$. Each of these planes is asymptotic to some orbit on L_+ , and the central orbit P is transverse to the foliation (Figure 3.2, left).

The results of this section may be summarized as follows. Given a contact form $\lambda = f(\rho)d\theta + g(\rho)d\phi$ on $S^1 \times \mathbb{R}^2$, if the trajectory $\rho \mapsto (f(\rho), g(\rho))$ winds sufficiently

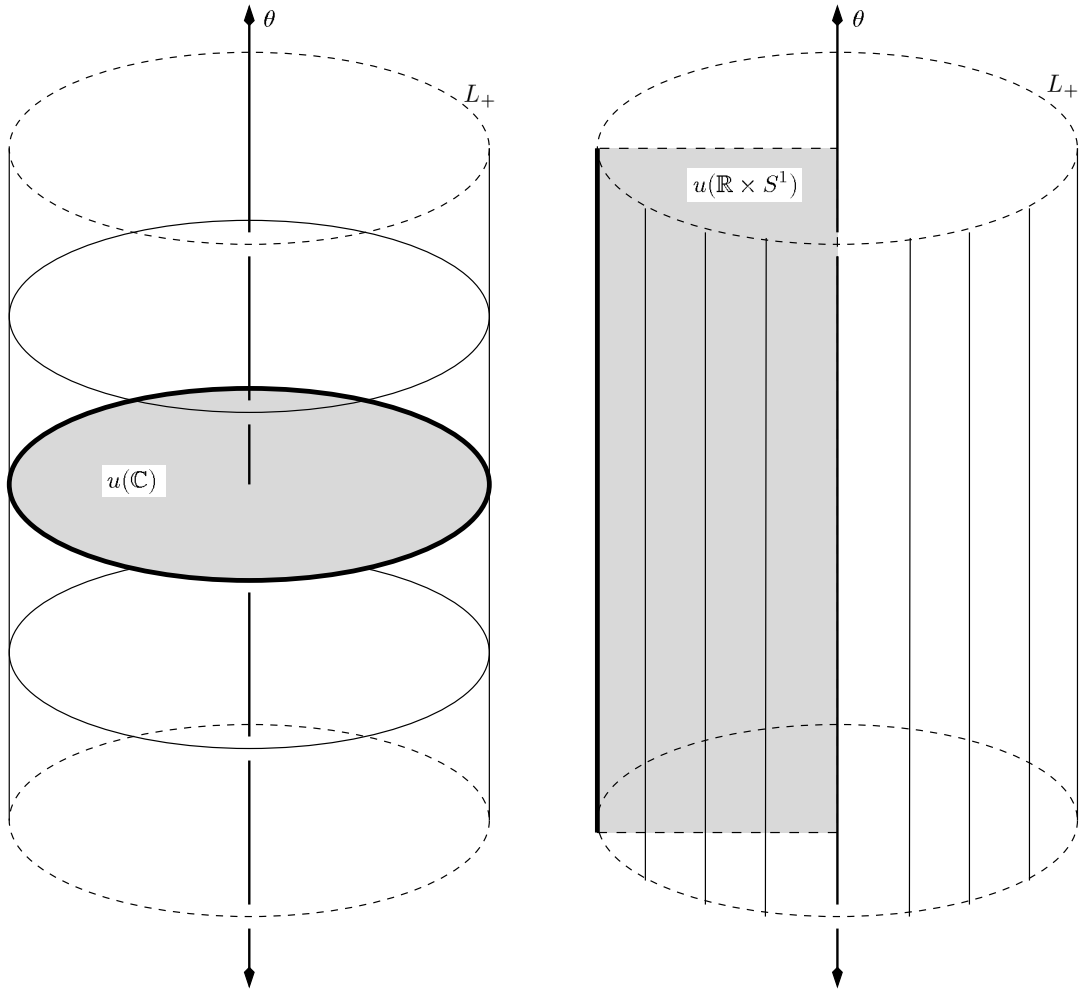

Figure 3.2: Holomorphic curves inside the innermost torus. If orbits on L_+ have nontrivial ∂_θ component (right), we get finite energy cylinders with a puncture asymptotic to the central axis; else that puncture is removable (left) and we get a finite energy plane.

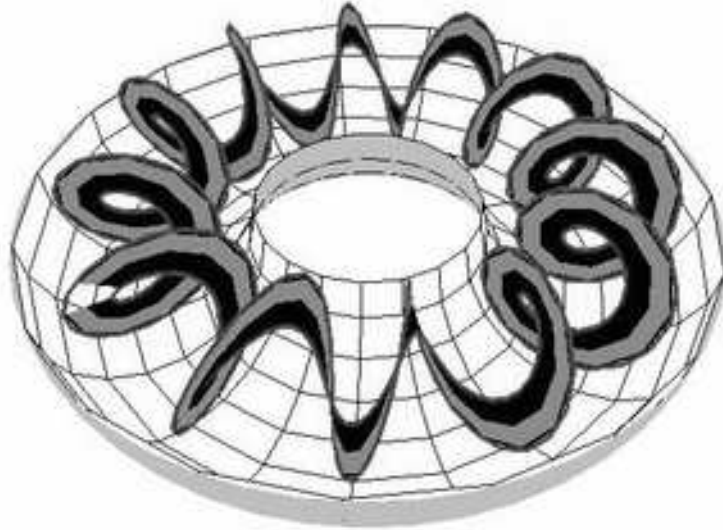

Figure 3.3: A cylinder of type (p, q) in $S^1 \times \mathbb{R}^2$ with $\rho_+ > \rho_- > 0$.

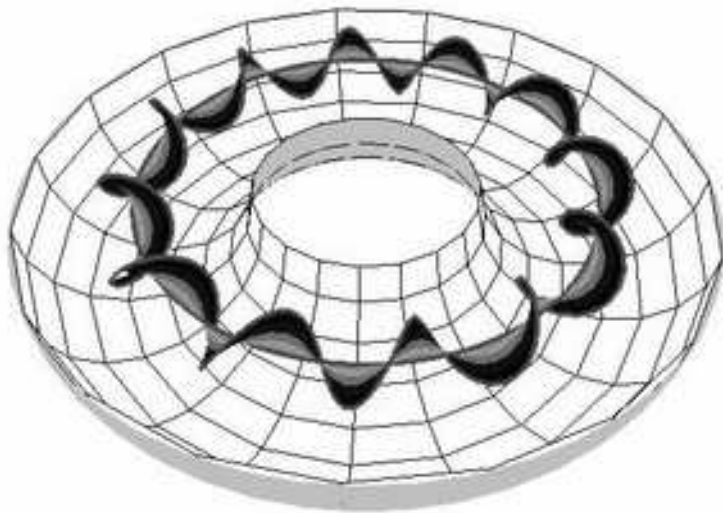

Figure 3.4: A cylinder of type (p, q) in $S^1 \times \mathbb{R}^2$ with $\rho_+ > \rho_- = 0$.

far around the origin, then we can single out certain concentric tori foliated by homologous periodic orbits and construct finite energy foliations with cylindrical leaves that span the regions between these tori. Depending on the homology class of the orbits on these tori, the leaves inside the innermost torus extend to the center either as finite energy cylinders with one end asymptotic to a (simple or multiple) cover of the central orbit, or as finite energy planes transverse to this orbit.

To put this in a wider context, consider a knot $K \subset S^3$, transverse to the standard contact structure ξ_0 . Cutting out a neighborhood $N_K \subset S^3$ and gluing in another neighborhood $N_{K'}$ of a circle K' , we obtain a new contact manifold (M, λ) , with λ constructed so that $\partial(N_K) = \partial(N_{K'})$ is a simple Morse-Bott manifold, foliated by periodic orbits that are meridians on $\partial(N_K)$. If the surgery is nontrivial, then these orbits are *not* meridians on $\partial(N_{K'})$, they represent some other homology class $p\mu + q\lambda \in H_1(\partial(N_{K'}))$. Then the cylinders of type (p, q) can be used to construct a Morse-Bott foliation inside $N_{K'}$.

Remark 3.1.5. *By the Lickorish-Wallace theorem, we can assume without loss of generality that the surgery is integral, i.e. $q = \pm 1$, in which case all asymptotic orbits of the new foliation are simply covered. We can also control the acceleration of the trajectory $\rho \mapsto (f(\rho), g(\rho))$ so that all Morse-Bott tori are positive, and thus all punctures at Morse-Bott orbits are positive. The sign of the puncture at $\rho = 0$ is determined by the sign of q , which is arbitrary.*

3.2 Local modifications and continuation

Later on it will be important to understand how finite energy foliations can be deformed globally in accordance with homotopies of the data (λ, J) . In general this requires Fredholm theory and the implicit function theorem. However, it is occasionally useful to take a more simple-minded and purely *local* approach. In this section we frame the question as follows: let $M = S^1 \times B_\epsilon^2(0)$ with $\lambda = f(\rho)d\theta + g(\rho)d\phi$ and $Jv_1 = \beta(\rho)v_2$ as in the previous section, and suppose we are given a smooth \mathbb{R} -invariant foliation by holomorphic curves either transverse or asymptotic to the orbit $P = S^1 \times \{0\}$. Now suppose the data (λ, J) are changed (preserving symmetry) within a smaller neighborhood $P \subset \mathcal{U} \subset M$. Is there now a foliation for the new data that matches the old foliation outside of \mathcal{U} ? If so, the new holomorphic curves in \mathcal{U} may be thought of as analytic continuations of the existing curves outside \mathcal{U} .

We will attack this problem with classical methods and find that some rather restrictive assumptions are required for such an approach to succeed. The result does have application: we'll use it in Sec. 5.1.5 to produce a holomorphic open book

decomposition for a setup in which J becomes non-smooth at the binding orbit. To set the stage, here is a simpler example.

Example 3.2.1. *The non-stable open book decomposition of (S^3, λ_0, i) described in Example 1.2.3 can be stabilized by a small change in λ_0 near the binding orbit P_∞ . To do this, identify a neighborhood of P_∞ with $S^1 \times B_R^2(0)$ for any $R \leq 1/\sqrt{2\pi}$, via the embedding*

$$\psi : S^1 \times B_R^2(0) \rightarrow S^3 : (\theta, \rho, \phi) \mapsto e^{2\pi i \theta} \left(\sqrt{1 - 2\pi \rho^2}, e^{i\phi} \sqrt{2\pi} \rho \right).$$

Then $\psi(S^1 \times \{0\}) = P_\infty$ and $\psi^* \lambda_0 = \pi(d\theta + \rho^2 d\phi) = f(\rho)d\theta + g(\rho)d\phi$, where $f(\rho) = \pi$ and $g(\rho) = \pi\rho^2$. The complex structure $i : \xi_0 \rightarrow \xi_0$ now takes the form

$$i v_1 = \beta(\rho) v_2 \quad \text{where} \quad \beta(\rho) = \frac{2\pi}{1 - 2\pi \rho^2}.$$

For $\zeta = r e^{i\phi_0} \in \mathbb{C} \setminus \{0\}$, we can express the asymptotic behavior of the holomorphic plane

$$\tilde{u}_\zeta(z) = (a_\zeta(z), u_\zeta(z)) = \left(\frac{1}{2} \ln |(z, \zeta)|, \frac{(z, \zeta)}{|(z, \zeta)|} \right)$$

in these coordinates by

$$\begin{aligned} (a(s, t), \rho(s, t), \theta(s, t), \phi(s, t)) &= (a(e^{-2\pi(s+it)}), \psi^{-1} \circ u_\zeta(e^{-2\pi(s+it)})) \\ &= \left(\frac{1}{4} \ln(e^{-4\pi s} + r^2), -t, \frac{r}{\sqrt{2\pi(e^{-4\pi s} + r^2)}}, \phi_0 + 2\pi t \right), \end{aligned} \quad (3.2.1)$$

with $(s, t) \in (-\infty, s_0] \times S^1$ for s_0 sufficiently close to $-\infty$. Thus \tilde{u}_ζ looks asymptotically like a cylinder of type $(-1, -1)$.

Now change the contact form by setting $\bar{\lambda} = \bar{f}(\rho)d\theta + \bar{g}(\rho)d\phi$ where \bar{f} and \bar{g} match f and g for ρ outside a neighborhood of 0; assume also that $\bar{f}/f \equiv \bar{g}/g$, so $\ker \bar{\lambda} = \ker \lambda_0 = \xi_0$. The new contact form defines a new symplectic framing $\{\bar{v}_1, \bar{v}_2\}$ of ξ_0 , and there is a function $\bar{\beta}(\rho)$ such that $i\bar{v}_1 = \bar{\beta}(\rho)\bar{v}_2$, where $\bar{\beta}(\rho) = \beta(\rho)$ outside a neighborhood of 0. Then there are unique functions $a(s)$ and $\rho(s)$ that solve the ODEs (3.1.10) for the new data and match (3.2.1) outside a neighborhood of $-\infty$. This gives a new open book decomposition for $(S^3, \bar{\lambda}, i)$ by holomorphic curves asymptotic to P_∞ and matching the family $\{\tilde{u}_\zeta\}$ everywhere on S^3 except near P_∞ .

This foliation will be stable if $\bar{f}(\rho)$ and $\bar{g}(\rho)$ can be chosen near $\rho = 0$ so that P_∞ is a nondegenerate orbit with $\mu_{CZ}(P_\infty) = 3$. (This follows from the wind_π estimates

and Fredholm theory in [HWZ95a] and [HWZ99] respectively; see also Chapter 4.) For this we use the formula of Prop. 3.1.2:

$$\mu_{CZ}^{v_0}(P_\infty) = 2 \left[-\frac{\bar{f}''(0)}{2\pi\bar{g}''(0)} \right] + 1, \quad (3.2.2)$$

where the superscript means this index is computed with respect to the trivialization of $\xi_0|_{P_\infty}$ defined by the section $v_0(\psi(\theta, 0, 0)) = \partial_x \psi(\theta, 0, 0)$. This section does not extend to a global trivialization of ξ_0 ; to fix this, we can define a global nonzero section by $v(z_1, z_2) = (-\bar{z}_2, \bar{z}_1) \in (\xi_0)_{(z_1, z_2)}$ for $(z_1, z_2) \in S^3 \subset \mathbb{C}^2$, and then compute

$$v_0(\psi(\theta, 0, 0)) = \partial_x \psi(\theta, 0, 0) = \sqrt{2\pi} e^{2\pi i \theta} (0, 1) = \sqrt{2\pi} e^{4\pi i \theta} v(\psi(\theta, 0, 0)).$$

Thus $\text{wind}_{P_\infty}^v(v_0) = 2$, and we must therefore add 4 to (3.2.2) in order to compute $\mu_{CZ}(P_\infty)$. This implies that $\mu_{CZ}(P_\infty) = 3$ if and only if

$$\left[-\frac{\bar{f}''(0)}{2\pi\bar{g}''(0)} \right] = -1.$$

Happily, this is already almost true for f and g ; it suffices to make a small perturbation so that $\bar{f}''(0)$ is slightly greater than zero, i.e. the slope of the trajectory $\rho \mapsto (\bar{f}(\rho), \bar{g}(\rho))$ begins at the f -axis with a slight slant to the right.

More generally, suppose the model $M = S^1 \times B_\epsilon^2(0)$ with contact form $\lambda = f(\rho)d\theta + g(\rho)d\phi$ and complex multiplication $Jv_1 = \beta(\rho)v_2$ lies within a larger contact manifold which already has a finite energy foliation, either transverse or asymptotic to $P = S^1 \times \{0\}$. We then choose a number $\delta \in (0, \epsilon)$ and new data

$$\bar{\lambda} = \bar{f}(\rho)d\theta + \bar{g}(\rho)d\phi, \quad \bar{J}v_1 = \bar{\beta}(\rho)v_2$$

such that $\bar{f}(\rho) = f(\rho)$, $\bar{g}(\rho) = g(\rho)$ and $\bar{\beta}(\rho) = \beta(\rho)$ for $\rho \in [\delta, \epsilon)$. Our goal is to find a new foliation with respect to $(\bar{\lambda}, \bar{J})$ that matches the old foliation outside some neighborhood of $S^1 \times B_\delta^2(0)$.

If the given foliation is transverse to P , then some portion of any leaf can be parametrized by a map $\tilde{u} = (a, u) = (a, \theta, \rho, \phi) : \mathbb{D} \rightarrow \mathbb{R} \times M$ such that $u(0) = (\theta_0, 0, \cdot) \in P$. If P is an asymptotic limit, we instead define \tilde{u} on $\dot{\mathbb{D}} = \mathbb{D} \setminus \{0\}$ so that u is asymptotic to P at 0. In either case, we can switch to holomorphic cylindrical coordinates via the transformation $(-\infty, 0] \times S^1 \rightarrow \dot{\mathbb{D}} : (s, t) \mapsto e^{2\pi(s+it)}$ and consider the functions

$$\tilde{u}(s, t) = (a(s, t), \theta(s, t), \rho(s, t), \phi(s, t))$$

for $(s, t) \in (-\infty, 0] \times S^1$. As $s \rightarrow -\infty$ we have $\rho(s, t) \rightarrow 0$, $\theta(s, t) \rightarrow \theta_0 + qt$ and $\phi(s, t) \rightarrow \phi_0 - 2\pi pt$ for some integers q and p . If $q = 0$ then the singularity at $s = -\infty$ is removable, so $a(s, t) \rightarrow a_0$ for some $a_0 \in \mathbb{R}$; else $a(s, t) \rightarrow \pm\infty$, with sign opposite the sign of q . These functions satisfy the nonlinear Cauchy-Riemann equations

$$\begin{aligned} a_s &= f\theta_t + g\phi_t & \rho_s &= \frac{1}{\beta}(f'\theta_t + g'\phi_t) \\ a_t &= -f\theta_s - g\phi_s & \rho_t &= -\frac{1}{\beta}(f'\theta_s + g'\phi_s) \end{aligned} \quad (3.2.3)$$

Then from the expressions $a_{st} - a_{ts} = 0$ and $\rho_{st} - \rho_{ts} = 0$, we derive

$$f\Delta\theta + g\Delta\phi = 0, \quad (3.2.4)$$

$$f'\Delta\theta + g'\Delta\phi - \frac{1}{\beta}(f'g'' - f''g')(\theta_s\phi_t - \theta_t\phi_s) = 0, \quad (3.2.5)$$

where f , g and β depend on $\rho(s, t)$.

We now switch to the new data $(\bar{f}, \bar{g}, \bar{\beta})$ and look for a solution $\tilde{v} : (-\infty, 0] \times S^1 \rightarrow \mathbb{R} \times M$ in the form

$$\tilde{v}(s, t) = (\bar{a}(s, t), \theta(s, t), \bar{\rho}(s, t), \phi(s, t))$$

such that there is some $s_0 \in (-\infty, 0)$ with $\tilde{v}(s, t) = \tilde{u}(s, t)$ for $s \geq s_0$. There's an ansatz here: θ and ϕ are required to be the same functions as before, while $\bar{\rho}$ and \bar{a} must match ρ and a only for $s \geq s_0$. This will not be possible in general. If θ and ϕ are fixed functions, then the equations for ρ in (3.2.3) can be interpreted as saying that the graph $\Gamma_\rho := \{(s, t, \rho(s, t))\}$ is tangent to a certain two-plane distribution in $(-\infty, 0] \times S^1 \times \mathbb{R}$. The distribution turns out to be integrable if and only if

$$\bar{f}'\Delta\theta + \bar{g}'\Delta\phi - \frac{1}{\bar{\beta}}(\bar{f}'\bar{g}'' - \bar{f}''\bar{g}')(\theta_s\phi_t - \theta_t\phi_s) \equiv 0. \quad (3.2.6)$$

This expression is to be understood as a function of three independent variables $(s, t, \rho) \in (-\infty, 0] \times S^1 \times \mathbb{R}$. If it vanishes identically then solutions $\bar{\rho}(s, t)$ exist locally. Assume this: then choosing $s_0 \in (-\infty, 0)$ such that $\rho(s, t) \geq \delta$ for all $s \geq s_0$, there is a solution $\bar{\rho}(s, t)$ on $(s_1, 0] \times S^1$ for some $s_1 < s_0$, with $\bar{\rho}(s, t) = \rho(s, t)$ for $s \geq s_0$. For topological reasons, the continued solution is automatically 1-periodic in t . Then for fixed t , $\rho(s, t)$ satisfies the ODE

$$\frac{d\bar{\rho}}{ds} = \frac{1}{\bar{\beta}(\bar{\rho})} (\bar{f}'(\bar{\rho})\theta_t + \bar{g}'(\bar{\rho})\phi_t),$$

and we see that the solution $\bar{\rho}(s, t)$ extends to $(-\infty, 0] \times S^1$ with $\lim_{s \rightarrow -\infty} \rho(s, t) = \rho_0$, where $\rho_0 \geq 0$ is the largest radius at which

$$\frac{f'(\rho_0)}{2\pi g'(\rho_0)} = \frac{p}{q},$$

or zero if there is no such radius.

The remaining two equations specify the gradient of $\bar{a}(s, t)$ in terms of known functions, so solutions exist locally if and only if this gradient is curl-free, which turns out to mean

$$\bar{f}\Delta\theta + \bar{g}\Delta\phi \equiv 0 \tag{3.2.7}$$

for all $(s, t) \in (-\infty, 0] \times S^1$, $\rho = \bar{\rho}(s, t)$. In this case there is a unique solution on $(-\infty, 0] \times S^1$ with $\bar{a}(s, t) = a(s, t)$ for all $s \geq s_0$. Fixing t , $\bar{a}(s, t)$ satisfies

$$\frac{d\bar{a}}{ds} = \bar{f}(\bar{\rho})\theta_t + \bar{g}(\bar{\rho})\phi_t \rightarrow q\bar{f}(\rho_0) - 2\pi p\bar{g}(\rho_0) \quad \text{as } s \rightarrow -\infty.$$

This expression is automatically nonzero if $\rho_0 > 0$ since the contact condition implies that $q\bar{f}(\rho_0) - 2\pi p\bar{g}(\rho_0)$ and $q\bar{f}'(\rho_0) - 2\pi p\bar{g}'(\rho_0)$ cannot both vanish. Thus $a(s, t)$ blows up linearly at the puncture in this case, and \tilde{v} is asymptotic to a periodic orbit on the torus $\{\rho = \rho_0\}$. For $\rho_0 = 0$, $a(s, t)$ blows up if $q \neq 0$, in which case \tilde{v} is asymptotic to P , and otherwise the puncture is removable.

The integrability conditions (3.2.6) and (3.2.7) are quite restrictive, but they are obviously satisfied in two cases:

- Suppose $f'g'' - f''g' \equiv \bar{f}'\bar{g}'' - \bar{f}''\bar{g}' \equiv 0$, which means that the trajectories $\rho \mapsto (f, g)$ and $\rho \mapsto (\bar{f}, \bar{g})$ both parametrize portions of the same straight line in \mathbb{R}^2 . Then (3.2.4) and (3.2.5) give

$$f\Delta\theta + g\Delta\phi = \bar{f}\Delta\theta + \bar{g}\Delta\phi = 0,$$

and since the contact condition requires (f, g) and (f', g') to be linearly independent in \mathbb{R}^2 for all ρ , we conclude that both $\theta(s, t)$ and $\phi(s, t)$ are harmonic. Now (3.2.6) and (3.2.7) are satisfied for all (s, t, ρ) , so any solution $\rho(s, t)$ can be continued to $(-\infty, 0] \times S^1$. This precludes any twisting of the contact form, but it can be used for Dehn surgery in some situations. It also allows arbitrary changes to $\bar{\beta}$ so long as $\lim_{\rho \rightarrow 0} \bar{\beta}(\rho) \neq 0$. In particular, $\bar{\lambda}$ and \bar{J} need not be smooth at P .

- Suppose $\theta_s\phi_t - \theta_t\phi_s \equiv 0$, then by the same arguments used above, θ and ϕ must be harmonic and (3.2.6) and (3.2.7) are automatically satisfied, this time for *any* choice of \bar{f} and \bar{g} . This is what happened in Example 3.2.1.

3.3 Nondegenerate perturbations

As we said in the introduction, it is a reasonable conjecture that every finite energy foliation of stable Morse-Bott type can be perturbed to a stable finite energy foliation, with nondegenerate asymptotic limits. A general proof of this would require some gluing estimates and the implicit function theorem, but for the explicitly constructed foliations in the previous section, we can use a simpler trick to obtain nondegenerate stable foliations in a neighborhood of $S^1 \times \{0\} \subset M$. As a bonus, this leads to explicit constructions of stable foliations for simple contact manifolds such as $S^1 \times S^2$ and T^3 , which provide some examples for the discussion of invariants in Chapter 6.

As in the previous section, let $M = S^1 \times \mathbb{R}^2$, with a contact form $\lambda = f(\rho)d\theta + g(\rho)d\phi$ where $D = fg' - f'g > 0$. Choose $\rho_+ > \rho_- > 0$ such that $g'(\rho_{\pm}) = 0$: then the tori $L_{\pm} = \{\rho = \rho_{\pm}\}$ are simple Morse-Bott submanifolds foliated by “horizontal” periodic orbits, of the form

$$x_{\pm}(t) = \left(\theta_0, \rho_{\pm}, \phi_0 - \frac{f'(\rho_{\pm})}{D(\rho_{\pm})}t \right).$$

We now define a perturbation λ^{ϵ} of λ , which has finite (even) numbers of periodic orbits on L_{\pm} , all nondegenerate. Choose a smooth cutoff function $\alpha(\rho)$ which is supported in two separate intervals around ρ_+ and ρ_- , and equals 1 near ρ_{\pm} . Choose also a small number $\epsilon > 0$, and two Morse functions $\mu_{\pm} : S^1 \rightarrow \mathbb{R}$. Here the Morse condition simply means that every critical point has nonvanishing second derivative, so the functions μ_{\pm} each have even numbers of critical points, alternating between local maxima and minima. Now, define a perturbed contact form on M as follows:

$$\lambda^{\epsilon} = \begin{cases} [1 + \epsilon\alpha(\rho)\mu_{\pm}(\theta)]\lambda & \text{for } \rho \in \text{supp}(\alpha), \\ \lambda & \text{for } \rho \in \alpha^{-1}(0). \end{cases}$$

This can be written in the form $\lambda^{\epsilon} = F(\theta, \rho)d\theta + G(\theta, \rho)d\phi$, with $F = (1 + \epsilon\alpha\mu)f$ and $G = (1 + \epsilon\alpha\mu)g$ for some function $\mu(\theta, \rho)$ which matches $\mu_{\pm}(\theta)$ when ρ is near ρ_{\pm} ; we will write μ' for $\partial_{\theta}\mu$. The Reeb vector field is

$$X_{\lambda^{\epsilon}}(\theta, \rho, \phi) = \frac{1}{D(1 + \epsilon\alpha\mu)^2} \left([g' + \epsilon\mu(\alpha'g + \alpha g')] \frac{\partial}{\partial \theta} - \epsilon\mu'\alpha g \frac{\partial}{\partial \rho} - [f' + \epsilon\mu(\alpha'f + \alpha f')] \frac{\partial}{\partial \phi} \right),$$

and in particular at $\rho = \rho_{\pm}$,

$$X_{\lambda^{\epsilon}}(\theta, \rho_{\pm}, \phi) = -\frac{1}{D(\rho_{\pm})} \left(\frac{\epsilon \mu'_{\pm}(\theta) g(\rho_{\pm})}{(1 + \epsilon \mu_{\pm}(\theta))^2} \frac{\partial}{\partial \rho} + \frac{f'(\rho_{\pm})}{1 + \epsilon \mu_{\pm}(\theta)} \frac{\partial}{\partial \phi} \right).$$

Thus for every critical point $\theta_{\pm}^j \in \text{Crit}(\mu_{\pm})$ there is a horizontal periodic orbit $P_{\pm}^j \subset L_{\pm}$, parametrized by

$$x_{\pm}^j(t) = \left(\theta_{\pm}^j, \rho_{\pm}, \phi_0 + \frac{t}{g(\rho_{\pm})(1 + \epsilon \mu_{\pm}(\theta_{\pm}^j))} \right),$$

with minimal period $T_{\pm}^j = 2\pi |g(\rho_{\pm})| \cdot (1 + \epsilon \mu_{\pm}(\theta_{\pm}^j))$. As in the Morse-Bott case, we can define a *sign* for the torus L_{\pm} by

$$\text{sgn}(L_{\pm}) = \text{sgn}[f'(\rho_{\pm})g''(\rho_{\pm}) - f''(\rho_{\pm})g'(\rho_{\pm})].$$

Proposition 3.3.1. *The orbits P_{\pm}^j are nondegenerate if ϵ is sufficiently small, and using the section $\partial_{\rho} \in \xi$ to define a trivialization Φ of ξ near L_{\pm} , we have*

$$\mu_{CZ}^{\Phi}(P_{\pm}^j) = \begin{cases} 0 & \text{if } \text{sgn}(\mu''_{\pm}(\theta_{\pm}^j)) = \text{sgn}(L_{\pm}), \\ 1 & \text{if } \mu''_{\pm}(\theta_{\pm}^j) < 0 \text{ and } L_{\pm} \text{ is positive,} \\ -1 & \text{if } \mu''_{\pm}(\theta_{\pm}^j) > 0 \text{ and } L_{\pm} \text{ is negative.} \end{cases}$$

In the last two cases, the orbit is elliptic.

We omit the proof. Notice that each of the tori L_{\pm} has an alternating pattern of elliptic and hyperbolic orbits, all oriented in the same direction as the original Morse-Bott orbits, and with approximately the same period.

Defining \tilde{J} as in the previous section, we can again find a foliation of the region $\{\rho \in (\rho_{-}, \rho_{+})\}$ by finite energy cylinders, essentially by guessing—but the loss of symmetry in the θ -direction makes the problem somewhat harder. We will not be able to find holomorphic cylinders

$$\tilde{u} : (\mathbb{R} \times S^1, i) \rightarrow (\mathbb{R} \times M, \tilde{J})$$

in any form nearly as simple as the ansatz that was used in the Morse-Bott case. The solution is not to abandon the ansatz, but rather to allow more general complex structures on $\mathbb{R} \times S^1$.

It's useful to adopt a more geometric perspective: given any almost complex manifold (W, J) , the set of embedded pseudoholomorphic curves $u : (S, j) \rightarrow (W, J)$ (with arbitrary domains) is in one-to-one correspondence with the set of complex

1-dimensional submanifolds, i.e. surfaces $S \subset W$ such that TS is invariant under J . Thus it will suffice for our purposes to find embeddings $\tilde{u} : \mathbb{R} \times S^1 \rightarrow \mathbb{R} \times M$ whose images have \tilde{J} -invariant tangent spaces. Then we can *define* a conformal structure on $\mathbb{R} \times S^1$ by $j = \tilde{u}^* \tilde{J}$, and we will be able to prove that this conformal structure is in fact equivalent to the standard structure i .

We use the following prescription (borrowed from [HWZ99]) for recognizing when a given embedding $\tilde{u} : S \rightarrow \mathbb{R} \times M$ is \tilde{J} -invariant. Choosing any smooth coordinate system (s, t) on an open subset of S , it suffices that \tilde{u} should satisfy the equation

$$\tilde{u}_s \wedge \tilde{u}_t = \tilde{J} \tilde{u}_s \wedge \tilde{J} \tilde{u}_t. \quad (3.3.1)$$

We refer to this as the *diffeomorphism-invariant Cauchy-Riemann equation*, since \tilde{u} is a solution if and only if $\tilde{u} \circ \varphi$ is also, for any diffeomorphism $\varphi : S \rightarrow S$. Writing $\tilde{u} = (a, u)$ and using the definition of \tilde{J} in terms of J and λ , (3.3.1) is equivalent to

$$a_s \pi_\lambda u_t - a_t \pi_\lambda u_s + \lambda(u_s) J \pi_\lambda u_t - \lambda(u_t) J \pi_\lambda u_s = 0. \quad (3.3.2)$$

In physicists' terminology, these equations have a kind of "gauge invariance," which we can exploit to simplify the problem by "choosing a gauge". This means we make the very sensible assumption that (3.3.2) has solutions $\tilde{u} = (a, u) : \mathbb{R} \times S^1 \rightarrow \mathbb{R} \times M$ of the form

$$\tilde{u}(s, t) = (a(s, t), \theta(s, t), \rho(s), 2\pi t),$$

where $\rho(s)$ is an arbitrary increasing diffeomorphism $\mathbb{R} \rightarrow (\rho_-, \rho_+)$. Indeed, if any of the cylinders from the Morse-Bott construction can be perturbed to nondegenerate cylinders in this setup, then they can necessarily be written in this form by composing with a (not necessarily holomorphic!) reparametrization of $\mathbb{R} \times S^1$, and the choice of $\rho(s)$ fixes this reparametrization uniquely. Since the setup is still fully symmetric in the ϕ -direction, it is also reasonable to suppose that a and θ depend only on s , thus

$$\tilde{u}(s, t) = (a(s), \theta(s), \rho(s), 2\pi t).$$

Now a simple computation reduces (3.3.2) to the pair of coupled ODEs,

$$\frac{GG_\theta da}{D_\epsilon ds} = \frac{D_\epsilon d\theta}{\beta ds} \quad (3.3.3a)$$

$$G_\rho \frac{da}{ds} = \beta G \frac{d\rho}{ds} \quad (3.3.3b)$$

where $D_\epsilon := FG_\rho - F_\rho G = (1 + \epsilon\alpha\mu)^2 D > 0$. Remember that F , G and D_ϵ depend on both ρ and θ . Since $\rho : \mathbb{R} \rightarrow (\rho_-, \rho_+)$ is assumed to be a diffeomorphism, we can think of a and θ as functions of ρ , turning this system into

$$\frac{da}{d\rho} = \frac{\beta G}{G_\rho} = \frac{D_\epsilon^2}{\beta G G_\theta} \frac{d\theta}{d\rho}.$$

Thus $\theta(\rho)$ satisfies the differential equation

$$\frac{d\theta}{d\rho} = \left[\frac{\beta(\rho)G(\theta, \rho)}{D_\epsilon(\theta, \rho)} \right]^2 \frac{G_\theta(\theta, \rho)}{G_\rho(\theta, \rho)}. \quad (3.3.4)$$

The graphs of solutions $\theta : (\rho_-, \rho_+) \rightarrow S^1$ to this equation are integral curves of the vector field

$$\begin{aligned} V(\theta, \rho) &= G_\rho(\theta, \rho) \frac{\partial}{\partial \rho} + \left[\frac{\beta(\rho)G(\theta, \rho)}{D_\epsilon(\theta, \rho)} \right]^2 G_\theta(\theta, \rho) \frac{\partial}{\partial \theta} \\ &= \left([1 + \epsilon\alpha(\rho)\mu(\theta)]g'(\rho) + \epsilon\alpha'(\rho)g(\rho)\mu(\theta) \right) \frac{\partial}{\partial \rho} \\ &\quad + \left[\frac{\beta(\rho)g(\rho)}{1 + \epsilon\alpha(\rho)\mu(\theta)} \right]^2 [\epsilon\alpha(\rho)g(\rho)\mu'(\theta)] \frac{\partial}{\partial \theta} \end{aligned}$$

in the $\theta\rho$ -plane. We assume ϵ is small enough so that the ∂_ρ -term vanishes only when $g'(\rho) = 0$. The ∂_θ -term vanishes for ρ outside neighborhoods of ρ_\pm since $\alpha(\rho) = 0$, and when $\rho = \rho_\pm$ it vanishes if and only if $\theta \in \text{Crit}(\mu_\pm)$. The integral curves are shown in Figure 3.5. Picking $\rho_0 \in (\rho_-, \rho_+)$ outside the support of α , we conclude the following:

- For any $\theta_0 \in S^1$, there is a unique solution $\theta : (\rho_-, \rho_+) \rightarrow S^1$ of (3.3.4) with $\theta(\rho_0) = \theta_0$, and this solution is constant for ρ outside $\text{supp}(\alpha)$.
- If $\theta(\rho_0) \in \text{Crit}(\mu_+)$ then $\theta(\rho) = \theta(\rho_0)$ for all $\rho \in [\rho_0, \rho_+)$, and a similar statement for critical points of μ_- .
- If $\theta(\rho_0) \notin \text{Crit}(\mu_\pm)$ then $\theta(\rho)$ converges to a critical point $\theta_\pm \in \text{Crit}(\mu_\pm)$ as $\rho \rightarrow \rho_\pm$, where $\text{sgn}(\mu''(\theta_\pm)) = \text{sgn}[g(\rho_\pm)g''(\rho_\pm)]$.

This last item comes from using (3.3.4) to compute the sign of $\frac{d}{d\rho}\mu(\theta(\rho))$ as ρ approaches ρ_\pm . Now using $fg' - f'g > 0$ and $g'(\rho_\pm) = 0$, we have $\text{sgn}[g(\rho_\pm)g''(\rho_\pm)] = -\text{sgn}[f'(\rho_\pm)g''(\rho_\pm)] = -\text{sgn}(L_\pm)$. Comparing the index computations in Prop. 3.3.1, we see that *generically*, $u(s, t)$ approaches an elliptic orbit on L_\pm as $s \rightarrow \pm\infty$.

Once the equation for $\theta(\rho)$ is solved, we can find $a(\rho)$ by integrating

$$\frac{da}{d\rho} = \frac{\beta(\rho)G(\theta(\rho), \rho)}{G_\rho(\theta(\rho), \rho)}, \quad (3.3.5)$$

and we see that the solutions are unique up to a constant; thus the solutions $\tilde{u}(s, t)$ come in 1-parameter families related by \mathbb{R} -translation.

The embedding $\tilde{u} : \mathbb{R} \times S^1 \rightarrow \mathbb{R} \times M$ can be treated as a pseudoholomorphic curve by defining the complex structure $j = \tilde{u}^* \tilde{J}$ on $\mathbb{R} \times S^1$. From (3.3.5), we see

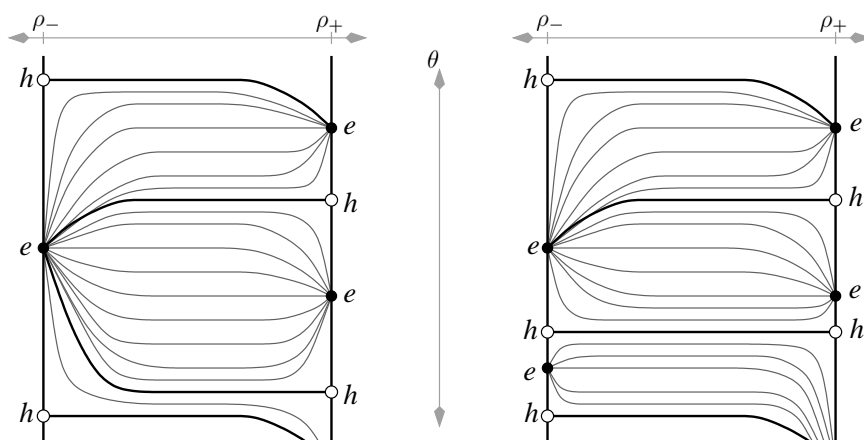

Figure 3.5: Two examples of the integral curves of $V(\theta, \rho)$, with the critical points of μ_{\pm} acting alternately as attractors or repellers. Equivalently, these are cross-sections of the resulting foliations in $\{\rho \in [\rho_-, \rho_+]\} \subset S^1 \times \mathbb{R}^2$. The darkened curves are rigid surfaces, and each orbit is labeled elliptic or hyperbolic. The foliation at the right is not stable; it includes an index 0 cylinder connecting two hyperbolic orbits.

that $a(s) \rightarrow \pm\infty$ as $s \rightarrow \pm\infty$, thus \tilde{u} is a proper map. Then by Prop. A.3.1, this fact and the asymptotic behavior of $u(s, t)$ are enough to conclude that \tilde{u} has finite energy and $(\mathbb{R} \times S^1, j)$ is conformally equivalent to the Riemann sphere with two punctures. In other words, the complex structure extends smoothly over the punctures, so we can reparametrize such that $j = i$.

We now have a family of pairwise non-intersecting embedded \tilde{J} -holomorphic cylinders

$$\tilde{u}_{(\sigma, \tau)} = (a_{(\sigma, \tau)}, \theta_{(\sigma, \tau)}, \rho_{(\sigma, \tau)}, \phi_{(\sigma, \tau)}) : \mathbb{R} \times S^1 \rightarrow \mathbb{R} \times M$$

parametrized by $\sigma \in \mathbb{R}$ and $\tau \in S^1$ such that the image of $\tilde{u}_{(\sigma, \tau)}$ contains the circle $\{(a, \theta, \rho) = (\sigma, \tau, \rho_0)\} \subset \mathbb{R} \times M$.

It's time to say a word about Fredholm indices and stability. By the results in [HWZ99], a holomorphic cylinder in $(\mathbb{R} \times M, \tilde{J})$ has Fredholm index

$$\text{Ind}(\tilde{u}) = \mu_{\text{CZ}}(\tilde{u}) + \#\Gamma - \chi(S^2) = \mu_{\text{CZ}}(\tilde{u}),$$

and we will show in Sec. 4.5.5 that the linearization of the Cauchy-Riemann equation is always surjective in this case if $\text{Ind}(\tilde{u}) \geq 1$. Let $\tilde{u} = (a, \theta, \rho, \phi) : \mathbb{R} \times S^1 \rightarrow \mathbb{R} \times M$ be a member of the family derived above, with asymptotic limits $P_{\pm} \subset L_{\pm}$ at $s = \pm\infty$. Comparing the natural orientations of $\{s\} \times S^1$ with those of P_{\pm} , we find that the sign of the puncture at $s = \pm\infty$ is precisely $\text{sgn}(L_{\pm})$. Then from Prop. 3.3.1,

$$\text{Ind}(\tilde{u}) = \mu_{\text{CZ}}(\tilde{u}) = \begin{cases} 2 & \text{if both orbits are elliptic,} \\ 1 & \text{if one orbit is elliptic and one is hyperbolic,} \\ 0 & \text{if both orbits are hyperbolic.} \end{cases}$$

So the foliation we've constructed in $\{\rho \in (\rho_-, \rho_+)\}$ is stable if and only if the third alternative never happens. As can be seen from Figure 3.5, it *should* never happen if the Morse functions μ_{\pm} are chosen generically; an isolated index 0 curve would cease to exist if one of its asymptotic orbits were moved slightly along L_{\pm} . In particular, it suffices to assume that μ_+ and μ_- have no critical points in common. Then there will be no cylinders connecting two hyperbolic orbits.

The foliation can be extended over the tori L_{\pm} , though it requires more than just orbit cylinders, since L_{\pm} are no longer foliated by periodic orbits. The pattern of alternating elliptic and hyperbolic orbits on L_{\pm} suggests, in view of the index computations above, that two such orbits could be connected by a rigid (i.e. index 1) cylinder. We therefore search for solutions $\tilde{u} = (a, u) : \mathbb{R} \times S^1 \rightarrow \mathbb{R} \times M$ to (3.3.2) in the form

$$\tilde{u}(s, t) = (a(s), \theta(s), \rho_{\pm}, 2\pi t),$$

where $\theta : \mathbb{R} \rightarrow S^1$ is a fixed diffeomorphism onto some open interval between neighboring critical points of μ_{\pm} . Now (3.3.3b) is satisfied trivially since $G_{\rho}(\theta, \rho_{\pm}) = 0$, and treating a as a function of θ , (3.3.3a) becomes

$$\frac{da}{d\theta} = \frac{[D_{\epsilon}(\theta, \rho_{\pm})]^2}{\beta(\rho_{\pm})G(\theta, \rho_{\pm})G_{\theta}(\theta, \rho_{\pm})},$$

This is well defined since $\theta(s) \notin \text{Crit}(\mu_{\pm})$ by assumption, and we can integrate to compute $a(s) = a(\theta(s))$ up to a constant. We thus find a 1-parameter family of solutions, related to each other by \mathbb{R} -translation. Again \tilde{u} is a proper map, since $\mu'(\theta(s)) \rightarrow 0$ implies $\frac{da}{d\theta} \rightarrow \pm\infty$ as $s \rightarrow \pm\infty$. Thus by Prop. A.3.1, \tilde{u} can be reparametrized to define a \tilde{J} -holomorphic finite energy cylinder. The asymptotic limits are a hyperbolic orbit $P_0 \subset L_{\pm}$ and an elliptic orbit $P_1 \subset L_{\pm}$, and we find by comparing orientations that the two punctures have opposite signs, with the sign at P_1 equal to the sign of L_{\pm} .

Adding to these rigid cylinders the family $\tilde{u}_{(\sigma, \tau)}$ and the orbit cylinders over each periodic orbit on L_{\pm} , we now have a foliation of $\{\rho \in [\rho_-, \rho_+]\} \subset \mathbb{R} \times M$ by holomorphic curves. This construction works on any interval $[\rho_-, \rho_+] \subset (0, \infty)$ with $g'(\rho_{\pm}) = 0$ and $g'(\rho) \neq 0$ for $\rho \in (\rho_-, \rho_+)$. The innermost region, where $\rho_- = 0$, can be filled by finite energy planes just as in the Morse-Bott case. Indeed, we only need to make a nondegenerate perturbation of λ near L_+ and find holomorphic cylinders in the region $\{\rho \in (0, \rho_+)\}$ by the methods above. Since $\alpha(\rho) = 0$ away from ρ_+ , this family of cylinders looks identical to the family constructed for the Morse-Bott case as $\rho \rightarrow 0$, thus the same argument as before allows us to remove the punctures at $s = -\infty$. By these methods, we can construct a stable finite energy foliation of the subset $\{\rho \leq \rho_0\} \subset \mathbb{R} \times (S^1 \times \mathbb{R}^2)$ for any ρ_0 with $g'(\rho_0) = 0$.

So far we've constructed nondegenerate perturbations for the cylinders of type $(1, 0)$ (and corresponding planes) from Sec. 3.1, but we'd also like to be able to perturb the cylinders of type (p, q) in general. In principle this is no more difficult, but since it's less convenient to write down the perturbed contact form λ^{ϵ} near a torus L_r with longitudinal periodic orbits, we shall take a less direct approach. The general situation is equivalent to the one already considered via a coordinate transformation. Indeed, given $\rho_+ > \rho_- > 0$ with $\frac{f'(\rho_{\pm})}{2\pi g'(\rho_{\pm})} = \frac{p}{q} \in \mathbb{Q} \cup \{\infty\}$, there is a linear change in the coordinates (θ, ϕ) for $\rho \in [\rho_-, \rho_+]$ which makes the orbits on L_{\pm} look like simply covered meridians. Then the methods above give a stable finite energy foliation for this region. Of course, this doesn't work for the innermost region, when $\rho_- = 0$; but here again we can simply observe that the cylinders constructed in the perturbed setup look identical to those of the Morse-Bott setup when ρ is outside $\text{supp}(\alpha)$. So these cylinders have the same behavior as $\rho \rightarrow 0$ in both the Morse-Bott and the nondegenerate pictures: the puncture at $s = -\infty$ is asymptotic

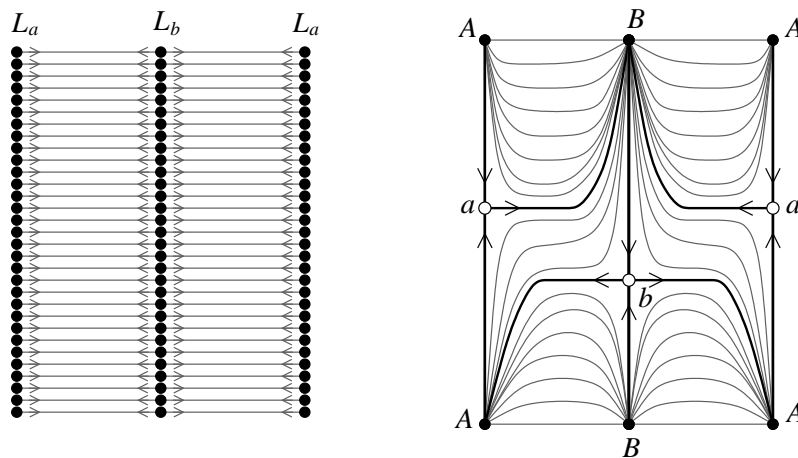

Figure 3.6: On the left is a cross section of a foliation of Morse-Bott type for T^3 , with two Morse-Bott tori L_a and L_b . Opposite edges of this diagram are identified. On the right is a nondegenerate perturbation, with one elliptic and one hyperbolic orbit on each of the original tori.

to a cover of the orbit $P = S^1 \times \{0\}$. Moreover, since $\mu_{CZ}(P)$ can be chosen to have any odd value, we can arrange for these cylinders all to have Fredholm index 1 or 2, depending on whether the limit at L_+ is hyperbolic or elliptic.

As we mentioned earlier, these ideas can be used to construct stable foliations for some simple examples of closed contact manifolds. For example, a Morse-Bott contact form on T^3 is obtained from $(S^1 \times \mathbb{R}^2, f(\rho)d\theta + g(\rho)d\phi)$ by choosing f and g to be 1-periodic and identifying $S^1 \times \partial B_1^2(0)$ with $S^1 \times \partial B_2^2(0)$. We can then use the methods of this chapter to construct a foliation of Morse-Bott type and a corresponding nondegenerate perturbation, as shown in Figure 3.6. $S^1 \times S^2$ can be treated similarly (Figures 3.7 and 3.8) by writing

$$S^1 \times S^2 \cong S^1 \times (\overline{B_1^2(0)}/\partial\overline{B_1^2(0)}).$$

In these diagrams we adopt the convention of labeling elliptic orbits with capital letters and hyperbolic orbits with lowercase. Arrows are used to indicate the sign of certain punctures, in a manner motivated by the notion of negative gradient flow: a puncture is negative if the arrow points toward the orbit, and otherwise positive. In these examples all punctures at elliptic orbits are positive.

We will use these constructions in Chapter 6 to compute some examples of a conjectured variation on contact homology arising from finite energy foliations.

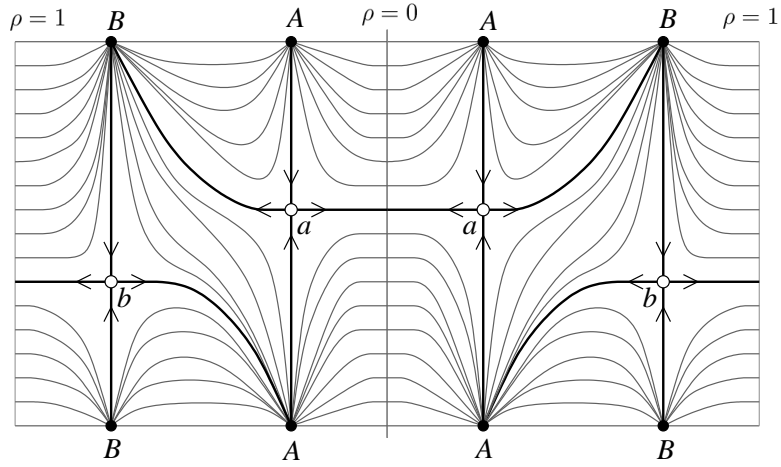

Figure 3.7: A cross section of a stable foliation for an overtwisted contact structure on $S^1 \times S^2$. The edges labeled $\rho = 1$ are identified to a single circle, which runs transversely through a family of holomorphic planes.

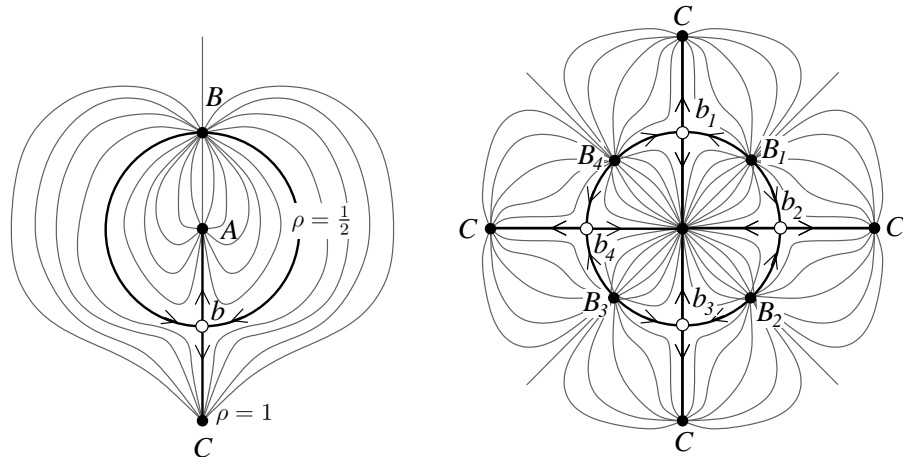

Figure 3.8: Two more foliations of the same contact structure on $S^1 \times S^2$ as in Figure 3.7, this time using “vertical” orbits, and viewed “from above”. One should imagine the region outside the torus labeled $\rho = 1/2$ as a reflection of the region inside. On the left we have a nondegenerate perturbation with two orbits on $\{\rho = 1/2\}$. At right, a perturbation with eight orbits on this torus.

Chapter 4

Holomorphic Curves with Boundary and Interior Punctures

4.1 Mixed boundary conditions and Problem (BP)

As outlined in Sec. 1.3, the intermediate steps of our main argument require the use of finite energy surfaces with boundary. The idea is to start with an ordinary finite energy surface (or a family of them), and cut out part of the domain so that we obtain a map defined on a punctured Riemann surface with smooth boundary, satisfying a totally real boundary condition. This trick creates a holomorphic curve whose image avoids a certain region of the target manifold, so we are then free to perform surgery in that region. After surgery, we can convert the surface with boundary back into an ordinary finite energy surface, using a noncompactness result to degenerate the boundary into a puncture. The details of this argument will be carried out in Chapter 5.

In this chapter we shall prove various technical results about the particular class of holomorphic curves with boundary that will be needed. We refer to such problems as “mixed” boundary value problems, because there are two types of “boundary” data: a totally real submanifold which describes behavior at the actual boundary, and a set of periodic orbits corresponding to the asymptotic behavior at the punctures. An example of such a problem appeared previously in the work of Hofer, Wysocki and Zehnder ([HWZ95a], [HWZ99] and [HWZ95b]): they considered holomorphic disks with multiple interior punctures (of negative sign), and boundary on a surface transverse to both the contact structure and the Reeb vector field. Their results are only loosely related to ours—we will need a slightly different set of assumptions about the totally real submanifold, e.g. that the nonsingular surface is *tangent* to the Reeb vector field. It should be emphasized that we will always as-

some punctures occur in the interior of our Riemann surface, never at the boundary. The latter situation is interesting and important in other contexts, e.g. in relative contact homology (cf. [EES02]).

In the following, (M, λ) is a closed contact 3-manifold, with contact structure ξ , Reeb vector field X_λ , and some choice of admissible complex multiplication J on ξ . We denote the natural vector field in the \mathbb{R} -direction on $\mathbb{R} \times M$ by ∂_a , and define \tilde{J} on $\mathbb{R} \times M$ as usual by $\tilde{J}\partial_a = X_\lambda$, $\tilde{J}|_\xi = J$. Choose an embedded surface L which is tangent to X_λ . As an example to keep in mind, L could be a Morse-Bott manifold of periodic orbits.

Choose any smooth function $G : L \rightarrow \mathbb{R}$ and define the surface $\tilde{L}_G \subset \mathbb{R} \times M$ to be the graph of G :

$$\tilde{L}_G = \{(G(x), x) \in \mathbb{R} \times M \mid x \in L\}.$$

Proposition 4.1.1. *For any choice of the function G , \tilde{L}_G is a totally real submanifold of $(\mathbb{R} \times M, \tilde{J})$.*

Proof. For any $x \in L$, denote $\tilde{x} = (G(x), x) \in \tilde{L}_G$. Choose a nonzero vector $v \in T_x L \cap \xi_x$, and observe that $\{X_\lambda(x), v\}$ forms a basis of $T_x L$. Then there exist real numbers p and q such that $\{Y, Z\} := \{p\partial_a + X_\lambda(x), q\partial_a + v\}$ is a basis of $T_{\tilde{x}}\tilde{L}_G$. The proposition is true if $\{Y, Z, \tilde{J}Y, \tilde{J}Z\}$ spans $T_{\tilde{x}}(\mathbb{R} \times M)$ for all x . Writing these as column vectors with respect to the basis $\{\partial_a, X_\lambda(x), v, Jv\}$, we obtain the matrix

$$\begin{pmatrix} p & q & -1 & 0 \\ 1 & 0 & p & q \\ 0 & 1 & 0 & 0 \\ 0 & 0 & 0 & 1 \end{pmatrix},$$

which has determinant $-p^2 - 1 \neq 0$. □

We will see that surfaces of the form \tilde{L}_G furnish a natural boundary condition for pseudoholomorphic curves in symplectizations. However, requiring the condition $\tilde{u}(\partial\Sigma) \subset \tilde{L}_G$ would be too simplistic, for the following reason. Our holomorphic curves with boundary will be obtained by starting from curves without boundary and cutting out pieces of the domain. The curves without boundary have very nice properties with regard to Fredholm theory, and we'd like to preserve these properties for the mixed boundary value problem. However, these properties are intertwined with the \mathbb{R} -invariance of the original problem, so we will have to formulate the new one in a way that preserves \mathbb{R} -invariance, at least locally. To that end, for any $\sigma \in \mathbb{R}$, denote by \tilde{L}_G^σ a translation of \tilde{L}_G in the \mathbb{R} -direction:

$$\tilde{L}_G^\sigma = \{(G(x) + \sigma, x) \in \mathbb{R} \times M \mid x \in L\}.$$

Now instead of asking for solutions that map a boundary circle into a single totally real submanifold, we shall require that they map the boundary into an element in a 1-parameter *family* of such submanifolds. This has the effect of raising the Fredholm index, and in our situation will also help ensure transversality.

To formulate all of this precisely, let Σ be a compact oriented surface with $m \geq 0$ boundary components, and let $\Gamma \subset \text{int } \Sigma$ be a finite subset. Denote the punctured surface by $\dot{\Sigma} = \Sigma \setminus \Gamma$, and choose an ordering of the boundary components $\partial\Sigma = \gamma_1 \cup \dots \cup \gamma_m$. Choose $\tilde{L}_1, \dots, \tilde{L}_m \subset \mathbb{R} \times M$ to be some collection of totally real surfaces of the type described above (they need not be distinct). We wish now to consider maps $\tilde{u} = (a, u) : \dot{\Sigma} \rightarrow \mathbb{R} \times M$ with the following properties:

- (i) \tilde{u} is pseudoholomorphic with respect to \tilde{J} and some complex structure j on Σ .
- (ii) \tilde{u} is asymptotically cylindrical (see Definition 1.1.9).
- (iii) For each connected component $\gamma_j \subset \partial\Sigma$, $j = 1, \dots, m$, we have the boundary condition $\tilde{u}(\gamma_j) \subset \tilde{L}_j^\sigma$ for some $\sigma \in \mathbb{R}$.

Condition (ii) implies that $u : \dot{\Sigma} \rightarrow \mathbb{R} \times M$ is asymptotic at each puncture to a periodic orbit of X_λ . We shall always assume that all such periodic orbits are either nondegenerate or belong to simple Morse-Bott submanifolds. In this case, let us refer to a map with all of these properties as a solution to Problem **(BP₀)**.

Example 4.1.2. *One way to obtain solutions to **(BP₀)** is as follows. Suppose $\dot{\Sigma}$ is a punctured surface without boundary, and we have 1-parameter family of finite energy surfaces $\tilde{u}_\tau = (a_\tau, u_\tau) : \dot{\Sigma} \rightarrow \mathbb{R} \times M$, such that the maps $u_\tau : \dot{\Sigma} \rightarrow M$ are embedded and foliate a subset of M . Suppose there is also a solid torus $N \subset M$, where $L := \partial N$ is tangent to X_λ and intersects each u_τ transversely. Then for each τ , the subset $\mathcal{D}_\tau = u_\tau^{-1}(\text{int } N) \subset \dot{\Sigma}$ is a finite union of smoothly embedded open disks, and $\dot{S}_\tau = \dot{\Sigma} \setminus \mathcal{D}_\tau$ is a compact surface with smooth boundary and interior punctures. One can then choose a function $G : L \rightarrow \mathbb{R}$ so that $\tilde{u}_\tau(\partial S_\tau) \subset \tilde{L}_G$, thus the restrictions of \tilde{u}_τ to \dot{S}_τ define a 1-parameter family of solutions to **(BP₀)**.*

*This construction is very elegant, but it may not be quite as useful for constructing foliations as one would expect. That's because we require some extra conditions on \tilde{L}_G in order to facilitate compactness arguments for solutions of **(BP₀)**; this will be discussed in Sec. 4.6.*

For technical reasons, we will also need to consider a non- \mathbb{R} -invariant generalization of problem **(BP₀)**. This is defined by choosing for each surface $L_j \subset M$ a smooth family of functions $\{G_j^\sigma : L_j \rightarrow \mathbb{R}\}_{\sigma \in \mathbb{R}}$ such that $\frac{\partial}{\partial \sigma} G_j^\sigma > 0$. We then define families of totally real submanifolds

$$\tilde{L}_j^\sigma = \{(G_j^\sigma(x), x) \in \mathbb{R} \times M \mid x \in L_j\},$$

and require that each component $\gamma_j \subset \partial\Sigma$ satisfy the boundary condition $\tilde{u}(\gamma_j) \subset \tilde{L}_j^\sigma$ for some $\sigma \in \mathbb{R}$. We will call this Problem **(BP)**. A further generalization to the context of a 4-manifold with cylindrical ends will be treated in Sec. 4.5, when we examine the Fredholm theory.

4.2 The Maslov index

4.2.1 Maslov and Conley-Zehnder indices

In any problem of this sort, the “boundary” conditions are described by some homotopy-invariant integer which will appear in the Fredholm index formula. In the case of a closed holomorphic curve, this is the first Chern number, and it becomes a Maslov index when totally real boundary conditions are added. When there are punctures, one needs the Conley-Zehnder indices of the corresponding asymptotic orbits. Both Maslov and Conley-Zehnder indices are necessary for the mixed boundary value problem.

Let $\tilde{u} = (a, u)$ be a solution of **(BP)** with nondegenerate asymptotic limits. Denote the limiting orbits at positive punctures by P_1^+, \dots, P_s^+ , and those at negative punctures by P_1^-, \dots, P_r^- . Since the domain $\dot{\Sigma}$ is not closed, the complex line bundle $u^*\xi \rightarrow \dot{\Sigma}$ admits a unitary trivialization $\Phi : u^*\xi \rightarrow \dot{\Sigma} \times \mathbb{C}$. (Here, “unitary” means that the trivialization is both complex with respect to J , and symplectic with respect to $d\lambda|_\xi$). From the asymptotic description of \tilde{u} in Appendix A, we know that Φ defines a trivialization of ξ over each asymptotic orbit, thus permitting us to define the Conley-Zehnder indices $\mu_{\text{CZ}}^\Phi(P_j^+)$ and $\mu_{\text{CZ}}^\Phi(P_j^-)$ (see [HWZ95a]). Note that the even/odd parity of $\mu_{\text{CZ}}^\Phi(P_j^\pm)$ is independent of Φ , thus we can characterize each puncture $z \in \Gamma$ as either *even* or *odd*, partitioning Γ into the subsets

$$\Gamma = \Gamma_0 \cup \Gamma_1.$$

In addition to asymptotic behavior, we must factor in the totally real boundary condition at $\partial\Sigma$. There are surfaces $L_1, \dots, L_m \subset M$, covered in the symplectization by families of totally real submanifolds $\tilde{L}_1^\sigma, \dots, \tilde{L}_m^\sigma$ parametrized by $\sigma \in \mathbb{R}$, such that for each connected component $\gamma_j \subset \partial\Sigma$, $\tilde{u}(\gamma_j) \subset \tilde{L}_j^\sigma$ for some σ . To simplify notation, denote $L = \bigcup_{j=1}^m L_j$, so then $u(\partial\Sigma) \subset L$. Since L is tangent to X_λ , it is also transverse to ξ , so there is a unique totally real subbundle $\ell \subset u^*\xi|_{\partial\Sigma} \rightarrow \partial\Sigma$ defined by

$$\ell_z = \xi_{u(z)} \cap T_{u(z)}L.$$

The trivialization Φ then allows us to define the boundary Maslov index (see [MS04]) of this totally real subbundle, denoted by $\mu^\Phi(u^*\xi, \ell)$.

A *generalized Maslov index* for \tilde{u} can now be defined as

$$\mu(\tilde{u}) = \sum_{j=1}^s \mu_{CZ}^{\Phi}(P_j^+) - \sum_{j=1}^r \mu_{CZ}^{\Phi}(P_j^-) + \mu^{\Phi}(u^*\xi, \ell). \quad (4.2.1)$$

It will follow from Prop. 4.2.2 below that the index doesn't depend on Φ . When there is no confusion, we shall simply refer to this as the *Maslov index* of \tilde{u} .

We will need a more general definition of $\mu(\tilde{u})$ in order to treat the case where \tilde{u} has Morse-Bott asymptotic limits. For computational purposes, it's also important to understand the properties of $\mu(\tilde{u})$ with respect to various operations that can be performed on the bundle $u^*\xi$. To this end, we introduce in the next section a more abstract framework for the Maslov index, and then use some of these ideas to treat the Morse-Bott situation in Sec. 4.2.3.

4.2.2 Bundles with boundary data

The generalized Maslov index

Let Σ be a compact oriented surface with boundary, and denote $\dot{\Sigma} = \Sigma \setminus \Gamma$, where $\Gamma = \Gamma^+ \cup \Gamma^-$ is a finite set of interior points partitioned into subsets labeled “positive” and “negative”. At this point the choice of sign for each puncture is purely arbitrary. It makes sense to think of $\dot{\Sigma}$ as a 2-manifold with boundary and positive and/or negative *cylindrical ends*, which means the following. For each puncture $z \in \Gamma$, choose a coordinate system identifying a neighborhood of $\mathcal{U}_z \ni z$ with the closed unit disk $\mathbb{D} \subset \mathbb{C}$, such that z is identified with $0 \in \mathbb{D}$. Denote the punctured neighborhood by $\dot{\mathcal{U}}_z = \mathcal{U}_z \setminus \{z\} \subset \dot{\Sigma}$. Depending on the sign of the puncture, we then identify $\dot{\mathcal{U}}_z$ with either the positive half-cylinder $Z^+ = [0, \infty) \times S^1$ or the negative half-cylinder $Z^- = (-\infty, 0] \times S^1$, using the diffeomorphisms

$$\begin{aligned} \varphi_+ : Z^+ &\rightarrow \mathbb{D} \setminus \{0\} : (s, t) \mapsto e^{-2\pi(s+it)} \\ \varphi_- : Z^- &\rightarrow \mathbb{D} \setminus \{0\} : (s, t) \mapsto e^{2\pi(s+it)} \end{aligned}$$

This defines for each puncture $z \in \Gamma$ a homeomorphism $\varphi_z : \dot{\mathcal{U}}_z \rightarrow Z^+$ or $\varphi_z : \dot{\mathcal{U}}_z \rightarrow Z^-$. In the special case where Σ is a Riemann surface, we can choose these homeomorphisms to be biholomorphic.

In general, Σ is required to have the structure of a topological manifold, and we must also assume that this restricts to a *smooth* structure (all coordinate transformations are smooth) in some neighborhood of Γ . Then the coordinate maps identifying \mathcal{U}_z with \mathbb{D} can be chosen as diffeomorphisms, so that the maps $\varphi_z : \dot{\mathcal{U}}_z \rightarrow Z^{\pm}$ are also smooth. There is then a special oriented topological 2-manifold with boundary

$\bar{\Sigma}$, known as the *circle compactification* of $\dot{\Sigma}$. This is defined from Σ by replacing each puncture $z \in \Gamma$ with the “circle at infinity,”

$$\delta_z := T_z \Sigma / \mathbb{R}^+,$$

where \mathbb{R}^+ is the multiplicative group of positive numbers. One can define this equivalently in the cylindrical coordinates above by replacing $[0, \infty) \times S^1$ or $(-\infty, 0] \times S^1$ with $[0, \infty] \times S^1$ or $[-\infty, 0] \times S^1$ respectively. Given the smoothness of the charts near z , this description uniquely determines a topology on $\bar{\Sigma}$, as well as a smooth structure on each of the circles $\delta_z \subset \partial \bar{\Sigma}$. These circles are given a special orientation defined by their identification with $\{\pm\infty\} \times S^1$: thus the orientation of δ_z matches that of $\partial \bar{\Sigma}$ if z is a positive puncture, and is otherwise the opposite.

In the case where Σ has a conformal structure, the natural inclusion $\dot{\Sigma} \hookrightarrow \bar{\Sigma}$ defines a *singular* conformal structure on $\bar{\Sigma}$. This structure degenerates at each of the circles δ_z , but also determines a preferred class of diffeomorphisms $\delta_z \cong S^1$, unique up to rotation.

Let $E \rightarrow \bar{\Sigma}$ be a topological Hermitian vector bundle of (complex) rank n , with complex and symplectic structures denoted by J and ω respectively. We assume E restricts to a *smooth* vector bundle over the circles $\delta_z \subset \partial \bar{\Sigma}$. Then we can associate with E a collection of *boundary data*, which consists of the following:

1. A totally real subbundle $\ell \subset E|_{\partial \Sigma} \rightarrow \partial \Sigma$
2. A bounded real linear operator $\mathbf{A}_z : H^1(E|_{\delta_z}) \rightarrow L^2(E|_{\delta_z})$ for each puncture $z \in \Gamma$; this is called an *asymptotic operator*. We assume that in some choice of smooth unitary trivialization $\Phi : E|_{\delta_z} \rightarrow S^1 \times \mathbb{R}^{2n}$, with sections of $E|_{\delta_z}$ represented by loops $\eta : S^1 \rightarrow \mathbb{R}^{2n}$, \mathbf{A}_z can be written as

$$(\mathbf{A}_z \eta)(t) = -J_0 \dot{\eta}(t) - S(t) \eta(t),$$

where J_0 is the standard complex structure on $\mathbb{R}^{2n} = \mathbb{C}^n$, and $S(t)$ is a smooth loop of symmetric matrices.

Operators of this type arise naturally when linearizing holomorphic curve equations on punctured domains, and there is such an operator associated with every periodic orbit of the Reeb vector field in a contact manifold (see Appendix A). In general, given a smooth 1-periodic loop of real symmetric $2n$ -by- $2n$ matrices $S(t)$, we can define an operator $\mathbf{A}_S : H^1(S^1, \mathbb{R}^{2n}) \rightarrow L^2(S^1, \mathbb{R}^{2n})$ by

$$(\mathbf{A}_S \eta)(t) = -J_0 \dot{\eta}(t) - S(t) \eta(t). \tag{4.2.2}$$

Then, as is well known, \mathbf{A}_S defines an unbounded self-adjoint operator on $L^2(S^1, \mathbb{R}^{2n})$ (or technically on its complexification), and the spectrum $\sigma(\mathbf{A}_S) \subset \mathbb{R}$ consists of

discrete eigenvalues of finite multiplicity that accumulate only at $\pm\infty$. We call \mathbf{A}_S *nondegenerate* if its kernel is trivial, i.e. $0 \notin \sigma(\mathbf{A}_S)$. This can be interpreted in terms of a linear Hamiltonian system on \mathbb{R}^{2n} ; indeed, $\mathbf{A}_S\eta = 0$ defines the differential equation

$$\dot{\eta}(t) = J_0 S(t)\eta(t),$$

which yields the Hamiltonian flow for the time-dependent quadratic function $H_t(\eta) = \frac{1}{2}\langle \eta, S(t)\eta \rangle$. Thus the flow is a 1-parameter family of linear symplectic matrices $\Psi_S(t) \in \mathrm{Sp}(n)$ for $t \in \mathbb{R}$, and \mathbf{A}_S is nondegenerate if and only if 1 is not an eigenvalue of $\Psi_S(1)$. In this case, we define $\mu_{\mathrm{CZ}}(\mathbf{A}_S)$ to be the Conley-Zehnder index for this path of matrices. This also defines the Conley-Zehnder index $\mu_{\mathrm{CZ}}^\Phi(\mathbf{A}_z)$ for any nondegenerate asymptotic operator $\mathbf{A}_z : H^1(E|_{\delta_z}) \rightarrow L^2(E|_{\delta_z})$ with smooth trivialization $\Phi : E|_{\delta_z} \rightarrow S^1 \times \mathbb{R}^{2n}$. We shall assume always that this trivialization covers an *orientation preserving* diffeomorphism $\delta_z \rightarrow S^1$ (using the special orientation of δ_z).

Since it will be important later to consider punctured holomorphic curves that have Morse-Bott asymptotic limits, we must add degenerate asymptotic operators to this picture. Define the perturbed operators

$$\mathbf{A}_S^\pm = \mathbf{A}_S \pm \epsilon,$$

with ϵ a small positive number. Since \mathbf{A}_S has a discrete spectrum, we deduce that \mathbf{A}_S^+ and \mathbf{A}_S^- are each nondegenerate and have uniquely defined Conley-Zehnder indices if $\epsilon > 0$ is sufficiently small. We can therefore define $\mu_{\mathrm{CZ}}^\Phi(\mathbf{A}_z^\pm)$ even if \mathbf{A}_z is degenerate. Of course if \mathbf{A}_z is nondegenerate, then $\mu_{\mathrm{CZ}}^\Phi(\mathbf{A}_z) = \mu_{\mathrm{CZ}}^\Phi(\mathbf{A}_z^\pm)$.

Definition 4.2.1. *Given a bundle $E \rightarrow \bar{\Sigma}$ with boundary data $\mathcal{B} = (\ell, \{\mathbf{A}_z\}_{z \in \Gamma})$, define the generalized Maslov index of (E, \mathcal{B}) by*

$$\mu(E, \mathcal{B}) = \sum_{z \in \Gamma^+} \mu_{\mathrm{CZ}}^\Phi(\mathbf{A}_z^-) - \sum_{z \in \Gamma^-} \mu_{\mathrm{CZ}}^\Phi(\mathbf{A}_z^+) + \mu^\Phi(E, \ell),$$

where Φ is any unitary trivialization $E \rightarrow \bar{\Sigma} \times \mathbb{R}^{2n}$ that restricts smoothly over the circles $\delta_z \subset \partial\bar{\Sigma}$.

Of course there is something to prove before this definition can make sense.

Proposition 4.2.2. *The index $\mu(E, \mathcal{B})$ does not depend on the trivialization Φ .*

Proof. This follows mainly from well known properties of the boundary Maslov and Conley-Zehnder indices. Denote the connected components of $\partial\bar{\Sigma}$ by $\gamma_1 \cup \dots \cup \gamma_m$, so then the oriented boundary of $\bar{\Sigma}$ is

$$\partial\bar{\Sigma} = \left(\bigcup_j \gamma_j \right) \cup \left(\bigcup_{z \in \Gamma^+} \delta_z \right) \cup \left(\bigcup_{z \in \Gamma^-} -\delta_z \right).$$

We focus on the case $n = 1$, since that is of greatest interest for our purposes. Then if Φ and Ψ are two unitary trivializations of $E \rightarrow \overline{\Sigma}$, we measure the difference between them by winding numbers: for any oriented circle $\gamma \subset \overline{\Sigma}$, let $\text{wind}_\gamma^\Phi(\Psi) \in \mathbb{Z}$ be the winding number along γ of the natural nonzero section defined by Ψ , with respect to the trivialization Φ . There is then the basic topological constraint, that the winding numbers over all boundary components must add up to zero:

$$\sum_{\gamma_j \subset \partial\Sigma} \text{wind}_{\gamma_j}^\Phi(\Psi) + \sum_{z \in \Gamma^+} \text{wind}_{\delta_z}^\Phi(\Psi) - \sum_{z \in \Gamma^-} \text{wind}_{\delta_z}^\Phi(\Psi) = 0. \quad (4.2.3)$$

Let $\mu_\gamma^\Phi(E, \ell)$ denote the boundary Maslov index for the bundle pair (E, ℓ) restricted to a given component $\gamma \subset \partial\Sigma$. Then we have

$$\mu_\gamma^\Psi(E, \ell) = \mu_\gamma^\Phi(E, \ell) + 2 \text{wind}_\gamma^\Phi(\Psi),$$

and similarly for the Conley-Zehnder index of any nondegenerate asymptotic operator \mathbf{A}_z ,

$$\mu_{\text{CZ}}^\Psi(\mathbf{A}_z) = \mu_{\text{CZ}}^\Phi(\mathbf{A}_z) + 2 \text{wind}_{\delta_z}^\Phi(\Psi).$$

Combining these formulas with (4.2.3) proves the result for $n = 1$. One could use the same argument for general n , replacing winding numbers with Maslov indices for loops of unitary matrices. \square

In this setting, we can partition Γ into sets of *even* and *odd* punctures according to the parity of $\mu_{\text{CZ}}^\Phi(\mathbf{A}_z^\pm)$. That is, we say $z \in \Gamma^\pm$ is odd if and only if $\mu_{\text{CZ}}^\Phi(\mathbf{A}_z^\mp)$ is odd (note the sign reversal). This is independent of Φ , and it defines disjoint subsets Γ_0^\pm and Γ_1^\pm so that

$$\Gamma = \Gamma^+ \cup \Gamma^- = \Gamma_0 \cup \Gamma_1 = \Gamma_0^+ \cup \Gamma_0^- \cup \Gamma_1^+ \cup \Gamma_1^-.$$

Operations on bundles

There is a natural direct sum operation for bundles with boundary data. Given two bundles $E_j \rightarrow \overline{\Sigma}$ with boundary data $\mathcal{B}_j = (\ell^j, \{\mathbf{A}_z^j\}_{z \in \Gamma})$, $j \in \{1, 2\}$, define boundary data for $E_1 \oplus E_2 \rightarrow \overline{\Sigma}$ by

$$\mathcal{B}_1 \oplus \mathcal{B}_2 = (\ell^1 \oplus \ell^2, \{\mathbf{A}_z^1 \oplus \mathbf{A}_z^2\}_{z \in \Gamma}).$$

Proposition 4.2.3. $\mu(E_1 \oplus E_2, \mathcal{B}_1 \oplus \mathcal{B}_2) = \mu(E_1, \mathcal{B}_1) + \mu(E_2, \mathcal{B}_2)$.

Proof. This follows at once from the corresponding additivity properties of the Maslov and Conley-Zehnder indices over each component of $\partial\overline{\Sigma}$. \square

An even simpler operation is the disjoint union: if $E_1 \rightarrow \overline{\Sigma}_1$ and $E_2 \rightarrow \overline{\Sigma}_2$ have the same rank n , then there is a natural rank n bundle

$$E_1 \sqcup E_2 \rightarrow \overline{\Sigma}_1 \sqcup \overline{\Sigma}_2,$$

which inherits boundary data $\mathcal{B}_1 \sqcup \mathcal{B}_2$ in a natural way. The following is then obvious:

Proposition 4.2.4. $\mu(E_1 \sqcup E_2, \mathcal{B}_1 \sqcup \mathcal{B}_2) = \mu(E_1, \mathcal{B}_1) + \mu(E_2, \mathcal{B}_2)$.

Somewhat less trivial is the behavior of the Maslov index with respect to gluing operations. One such operation is the gluing of two bundles along boundary components. Suppose $\dot{\Sigma}_1 = \Sigma_1 \setminus \Gamma^1$ and $\dot{\Sigma}_2 = \Sigma_2 \setminus \Gamma^2$ are two surfaces satisfying the assumptions above, and we have bundles $E_1 \rightarrow \overline{\Sigma}_1$ and $E_2 \rightarrow \overline{\Sigma}_2$ of the same rank n , with boundary data $\mathcal{B}_j = (\ell^j, \{\mathbf{A}_z\}_{z \in \Gamma^j})$ for $j \in \{1, 2\}$. Pick two circles $\alpha \subset \partial \Sigma_1$ and $\beta \subset \partial \Sigma_2$, along with an orientation reversing homeomorphism $\psi : \alpha \rightarrow \beta$, and define

$$\Sigma_1 \#_{(\psi)} \Sigma_2$$

to be the surface obtained by gluing Σ_1 and Σ_2 along α and β via ψ . This surface inherits the punctures in $\Gamma^1 \cup \Gamma^2$, and $\Sigma_1 \#_{(\psi)} \Sigma_2$ has the natural compactification

$$\overline{\Sigma_1 \#_{(\psi)} \Sigma_2} = \overline{\Sigma}_1 \#_{(\psi)} \overline{\Sigma}_2.$$

If ψ is covered by a unitary bundle isomorphism $\Psi : E_1|_{\alpha} \rightarrow E_2|_{\beta}$, then we can also glue the bundles by identifying $v \in E_1|_{\alpha}$ with $\Psi(v) \in E_2|_{\beta}$, defining a larger Hermitian bundle

$$E_1 \#_{(\Psi)} E_2 \rightarrow \overline{\Sigma_1 \#_{(\psi)} \Sigma_2}.$$

This has a natural set of boundary data

$$\mathcal{B}_1 \#_{(\Psi)} \mathcal{B}_2 = (\ell^1|_{\partial \Sigma_1 \setminus \alpha} \cup \ell^2|_{\partial \Sigma_2 \setminus \beta}, \{\mathbf{A}_z\}_{z \in \Gamma^1}, \{\mathbf{A}_z\}_{z \in \Gamma^2}).$$

The gluing map Ψ will be called *admissible* if $\Psi(\ell^1|_{\alpha})$ and $\ell^2|_{\beta}$ are homotopic as totally real subbundles over β ; we then call $\#_{(\Psi)}$ an *admissible gluing operation*, and denote the resulting bundle with boundary data by

$$(E_1, \mathcal{B}_1) \#_{(\Psi)} (E_2, \mathcal{B}_2) = (E_1 \#_{(\Psi)} E_2, \mathcal{B}_1 \#_{(\Psi)} \mathcal{B}_2).$$

Note that admissibility is only possible if the subbundles $\ell_1|_{\alpha}$ and $\ell_2|_{\beta}$ are simultaneously either orientable or non-orientable, i.e. their Maslov indices have the same parity.

One can define similar operations for a single bundle (E, \mathcal{B}) over $\overline{\Sigma}$ by choosing α and β to be separate components of $\partial \Sigma$. The homeomorphism $\psi : \alpha \rightarrow \beta$ must

still reverse orientation, and the bundle isomorphism Ψ is admissible if $\Psi(\ell|_\alpha)$ is homotopic to $\ell|_\beta$. The resulting operation is called a *contraction*, and it defines a bundle

$$\mathrm{tr}_{(\Psi)} E \rightarrow \overline{\mathrm{tr}_{(\psi)} \Sigma}$$

with boundary data $\mathrm{tr}_{(\Psi)} \mathcal{B}$, on a surface $\mathrm{tr}_{(\psi)} \Sigma$ with two fewer boundary components than Σ . Gluing operations can also be viewed as contractions for bundles over surfaces with multiple components. By composing gluing operations with contractions, we can also define admissible operations that glue multiple pairs of boundary circles at once.

A pair of punctures can be glued if they have opposite signs and the same parity. Let $z \in \Gamma^1 \subset \Sigma_1$ and $w \in \Gamma^2 \subset \Sigma_2$, with positive and negative signs respectively. Then an orientation *preserving* homeomorphism $\psi : \delta_z \rightarrow \delta_w$ is actually orientation reversing as a map between components of $\partial \overline{\Sigma}_1$ and $\partial \overline{\Sigma}_2$. We can thus use ψ to glue the compactified surfaces $\overline{\Sigma}_1$ and $\overline{\Sigma}_2$. More precisely, define $\Sigma_1 \#_{(\psi)} \Sigma_2$ as the compact surface obtained by first replacing $z \in \Sigma_1$ and $w \in \Sigma_2$ with their respective circles at infinity, and then gluing these via ψ . The glued surface has a natural set of punctures

$$\Gamma^1 \#_{(\psi)} \Gamma^2 = (\Gamma^1 \setminus \{z\}) \cup (\Gamma^2 \setminus \{w\}),$$

and the circle compactification of the punctured surface is simply $\overline{\Sigma_1 \#_{(\psi)} \Sigma_2} = \overline{\Sigma}_1 \#_{(\psi)} \overline{\Sigma}_2$.

The glued bundle $E_1 \#_{(\psi)} E_2 \rightarrow \overline{\Sigma_1 \#_{(\psi)} \Sigma_2}$ and boundary data $\mathcal{B}_1 \#_{(\psi)} \mathcal{B}_2$ are defined in the obvious way for any unitary bundle isomorphism $\Psi : E_1|_{\delta_z} \rightarrow E_2|_{\delta_w}$ covering ψ . If Ψ is smooth, it defines isomorphisms $\Psi_* : L^2(E_1|_{\delta_z}) \rightarrow L^2(E_2|_{\delta_w})$ and $\Psi^* : H^1(E_1|_{\delta_z}) \rightarrow H^1(E_2|_{\delta_w})$, such that for any asymptotic operator $\mathbf{A} : H^1(E_2|_{\delta_w}) \rightarrow L^2(E_2|_{\delta_w})$, the natural push-forward

$$\Psi_* \mathbf{A} = \Psi_* \circ \mathbf{A} \circ \Psi_*^{-1} : H^1(E_2|_{\delta_w}) \rightarrow L^2(E_2|_{\delta_w})$$

also has the form of an asymptotic operator. Then we call the gluing operation $\#_{(\psi)}$ *admissible* if the operators \mathbf{A}_w^+ and $\Psi_* \mathbf{A}_z^-$ are homotopic as nondegenerate asymptotic operators. This is only possible if both punctures have the same parity.

Contractions of punctures can similarly be defined by gluing two punctures on the same surface that have the same parity and opposite signs. One can also speak of admissible gluing operations that involve multiple pairs of punctures, or a mixture of punctures and boundary components.

Proposition 4.2.5. *For any bundle with boundary data (E, \mathcal{B}) and an admissible contraction $\mathrm{tr}_{(\Psi)}$,*

$$\mu(\mathrm{tr}_{(\Psi)}(E, \mathcal{B})) = \mu(E, \mathcal{B}).$$

Similarly,

$$\mu((E_1, \mathcal{B}_1) \#_{(\Psi)} (E_2, \mathcal{B}_2)) = \mu(E_1, \mathcal{B}_1) + \mu(E_2, \mathcal{B}_2).$$

for any admissible gluing operation on two such bundles.

Proof. It suffices to consider two cases: (i) a contraction of two boundary components, and (ii) a contraction of two punctures. Every other operation can be built from these ingredients together with disjoint unions (see Prop. 4.2.4).

Consider now a contraction on (E, \mathcal{B}) for two components $\alpha, \beta \subset \Sigma$. The bundle $\mathrm{tr}_{(\Psi)} E \rightarrow \overline{\mathrm{tr}_{(\Psi)} \Sigma}$ contains an oriented circle $C \subset \mathrm{int}(\mathrm{tr}_{(\Psi)} \Sigma)$ with distinguished homeomorphisms $\alpha \cong C$ and $\beta \cong -C$, as well as a distinguished pair of totally real subbundles ℓ^α and ℓ^β over C , which are homotopic. One obtains $E \rightarrow \overline{\Sigma}$ from $\mathrm{tr}_{(\Psi)} E \rightarrow \overline{\mathrm{tr}_{(\Psi)} \Sigma}$ by cutting $\mathrm{tr}_{(\Psi)} \Sigma$ along C , using α and β to label the two new boundary components, and supplementing the boundary data $\mathrm{tr}_{(\Psi)} \mathcal{B}$ with the totally real subbundles ℓ^α and ℓ^β over these two components. Then α and β cancel each other out in computing the Maslov index: indeed, given any trivialization Φ of $\mathrm{tr}_{(\Psi)} E$, this determines a trivialization of E , and we have

$$\mu_\alpha^\Phi(E, \ell^\alpha) = -\mu_\beta^\Phi(E, \ell^\beta)$$

due to the reversal of orientation and homotopy invariance of the index. This proves the result for contractions of boundary components.

A virtually identical argument applies to the contraction of two punctures as well. \square

Remark 4.2.6. *This formalism extends to the case of a Hermitian bundle E over a closed surface Σ by defining $\mu(E) = 2\langle c_1(E, J), [\Sigma] \rangle$. Then additivity under gluing still holds: in particular one can glue two surfaces without punctures together along their entire boundaries to obtain a closed surface.*

An important special case of a gluing operation is known as *doubling*. This can be used to turn a question about surfaces with boundary and punctures into one about surfaces without boundary or without punctures. We shall use it in particular to eliminate boundaries.

Let $E \rightarrow \overline{\Sigma}$ be a bundle with boundary data \mathcal{B} , as defined above. We must first define what we mean by the *conjugate*, or *opposite* of (E, \mathcal{B}) . From the underlying surface Σ we define the conjugate surface Σ^c to be a copy of Σ with the opposite orientation. An important special case is the conjugate of a Riemann surface (Σ, j) : the complex structure j^c is defined on Σ^c by $j^c = -j$. Alternatively one can define this by replacing all holomorphic coordinate charts $\varphi : \mathcal{U} \rightarrow \mathbb{C}$ with their complex conjugates, $\varphi^c(p) = \overline{\varphi(p)}$. There is a natural orientation reversing homeomorphism

$\Sigma \rightarrow \Sigma^c$, which is antiholomorphic in the case of a Riemann surface. Given a point $z \in \Sigma$ or a subset $\mathcal{U} \subset \Sigma$, we will denote its image in Σ^c by z^c or \mathcal{U}^c .

For a punctured surface $\dot{\Sigma} = \Sigma \setminus \Gamma$, we also conjugate the special coordinate maps $\varphi_z : \dot{\mathcal{U}}_z \rightarrow Z^\pm : p \mapsto (s, t)$, replacing them with $\varphi_z^c : \dot{\mathcal{U}}_z^c \rightarrow Z^\mp : p^c \mapsto (-s, t)$. In this way the maps φ_z^c remain holomorphic (if Σ has a conformal structure), and in general the signs of $z \in \Gamma$ and $z^c \in \Gamma^c$ are always opposite. The compactification $\bar{\Sigma}^c$ is now defined by the standard recipe: note that since both the orientation of Σ and the sign of each puncture gets reversed, the natural homeomorphism $\bar{\Sigma} \rightarrow \bar{\Sigma}^c$ actually induces orientation *preserving* diffeomorphisms $\delta_z \rightarrow \delta_{z^c}$ for each $z \in \Gamma$.

The conjugate of the Hermitian bundle $(E, J, \omega) \rightarrow \bar{\Sigma}$ is similarly defined as $(E^c, J^c, \omega^c) \rightarrow \bar{\Sigma}^c$ with $E^c = E$, $J^c = -J$ and $\omega^c = -\omega$. (The Hermitian metric $g = \omega(\cdot, J\cdot)$ is thus the same on both bundles.) There is a natural antiunitary bundle isomorphism $E \rightarrow E^c : v \mapsto v^c$, which covers the natural homeomorphism $\Sigma \rightarrow \Sigma^c$. To every local trivialization $\Phi : E|_{\mathcal{U}} \rightarrow \mathcal{U} \times \mathbb{C}^n : v \mapsto (p, V)$ one can associate a conjugate trivialization $\Phi^c : E^c|_{\mathcal{U}^c} \rightarrow \mathcal{U}^c \times \mathbb{C}^n : v^c \mapsto (p^c, \bar{V})$, which is unitary if and only if Φ is.

In defining the boundary data \mathcal{B}^c , the choice of subbundle $\ell^c \rightarrow \partial\Sigma^c$ is obvious. For the asymptotic operators at $z^c \in \Gamma^c$, we use the natural identification maps $\delta_z \rightarrow \delta_{z^c}$ and $E \rightarrow E^c$ to define isomorphisms

$$\begin{aligned} C &: L^2(E|_{\delta_z}) \rightarrow L^2(E^c|_{\delta_{z^c}}), \\ C &: H^1(E|_{\delta_z}) \rightarrow H^1(E^c|_{\delta_{z^c}}), \end{aligned}$$

then set $\mathbf{A}_{z^c} = -C\mathbf{A}_z C^{-1}$. The minus sign is the price we pay for the fact that the natural bundle isomorphism $E \rightarrow E^c$ is *anti*-unitary: its presence is needed to ensure that \mathbf{A}_{z^c} takes the standard form of an asymptotic operator. Indeed, if $(\mathbf{A}_z \eta)(t) = -J_0 \dot{\eta}(t) - S(t)\eta(t)$ in some trivialization Φ , then writing \mathbf{A}_{z^c} with respect to Φ^c , we find

$$(\mathbf{A}_{z^c} \eta)(t) = -J_0 \dot{\eta}(t) - S^c(t)\eta(t)$$

for the loop of symmetric matrices defined by

$$S^c(t) = -KS(t)K, \tag{4.2.4}$$

where K is the real $2n$ -by- $2n$ matrix that represents complex conjugation on $\mathbb{R}^{2n} = \mathbb{C}^n$.

Proposition 4.2.7. *For any bundle E with boundary data \mathcal{B} ,*

$$\mu(E, \mathcal{B}) = \mu(E^c, \mathcal{B}^c).$$

Proof. Given a trivialization Φ of E , we use the conjugate trivialization Φ^c to compute $\mu(E^c, \mathcal{B}^c)$. The first step is to show that for any component $\gamma \subset \partial\Sigma$,

$$\mu_\gamma^\Phi(E, \ell) = \mu_{\gamma^c}^{\Phi^c}(E^c, \ell^c).$$

In the trivializations, ℓ^c appears as the complex conjugate of ℓ , which reverses the sign of the Maslov index; however, a second sign reversal results from the fact that γ^c and γ have opposite orientations.

We will be done if we can show that $\mu_{\text{CZ}}^\Phi(\mathbf{A}_z^\pm) = -\mu_{\text{CZ}}^{\Phi^c}(\mathbf{A}_{z^c}^\mp)$. By (4.2.4), this would mean that the two linear Hamiltonian systems

$$\begin{aligned}\dot{\eta}(t) &= J_0 S_\epsilon(t) \eta(t), \\ \dot{\eta}(t) &= -J_0 K S_\epsilon(t) K \eta(t)\end{aligned}$$

give rise to symplectic flows with opposite Conley-Zehnder indices. Here $S_\epsilon(t) := S(t) + \epsilon$, where ϵ is a real number arbitrarily close to 0, chosen to ensure that both systems are nondegenerate. Suppose $A(t) \in \text{Sp}(n)$ satisfies $\dot{A}(t) = J_0 S_\epsilon(t) A(t)$ and $A(0) = \mathbf{1}$; then one verifies that $A_1(t) := K A(t) K$ is also a path of symplectic matrices, and satisfies

$$\dot{A}_1(t) = -J_0 K S_\epsilon(t) K A_1(t).$$

We claim that $\mu_{\text{CZ}}(A) = -\mu_{\text{CZ}}(A_1)$. Since $A(t)$ and $A_1(t)$ always have the same spectrum (remember $K = K^{-1}$) and μ_{CZ} is invariant under suitable homotopies, it suffices to check this for paths $A(t)$ in one of the canonical forms

$$A(t) = \begin{pmatrix} e^{2\pi i(m+\frac{1}{2})t} & & & \\ & e^{\pi i t} & & \\ & & \ddots & \\ & & & e^{\pi i t} \end{pmatrix}, \quad \mu_{\text{CZ}}(A) = 2m + n,$$

or

$$A(t) = \begin{pmatrix} e^{2\pi i m t} \begin{pmatrix} e^{-t} & \\ & e^t \end{pmatrix} & & & \\ & e^{\pi i t} & & \\ & & \ddots & \\ & & & e^{\pi i t} \end{pmatrix}, \quad \mu_{\text{CZ}}(A) = 2m + n - 1.$$

The rest is a routine computation. □

Now, define $\psi : \partial\Sigma \rightarrow \partial\Sigma^c$ as the natural orientation reversing homeomorphism, and choose $\Psi : E|_{\partial\Sigma} \rightarrow E^c|_{\partial\Sigma}$ to be the unique unitary bundle isomorphism that maps v to v^c for every $v \in \ell|_{\partial\Sigma}$. The *double* of (E, \mathcal{B}) is then defined as

$$(E^D, \mathcal{B}^D) = (E, \mathcal{B}) \#_{(\psi)} (E^c, \mathcal{B}^c).$$

The base $\Sigma^D = \Sigma \#_{(\psi)} \Sigma^c$ is a compact oriented surface with punctures (twice as many as before, evenly divided between positive and negative) and no boundary. From Props. 4.2.5 and 4.2.7, we immediately have

Corollary 4.2.8. *For any bundle E with boundary data \mathcal{B} ,*

$$\mu(E^D, \mathcal{B}^D) = 2\mu(E, \mathcal{B}).$$

Remark 4.2.9. *If (Σ, j) is a Riemann surface, the closed surface Σ^D obtained by gluing Σ to Σ^c along the boundary inherits a natural complex structure j^D , due to the Schwartz reflection principle. One can see this by defining Σ^c in terms of conjugate holomorphic charts, and piecing charts from Σ and Σ^c together to define Σ^D . Thus Σ^D also inherits a natural smooth structure, and its tangent bundle is well defined. $(T\Sigma^D, j^D)$ is then the double of $(T\Sigma, j)$ as a complex line bundle, glued along the totally real subbundle $T(\partial\Sigma) \rightarrow \partial\Sigma$.*

Conley-Zehnder indices and winding numbers

It will be useful to recall the relations proved in [HWZ95a] between the spectrum of an asymptotic operator \mathbf{A}_z and its Conley-Zehnder index in the case $n = 1$.

A nonzero eigenfunction $\eta \in H^1(S^1, \mathbb{R}^2)$ with $\mathbf{A}_S \eta = \lambda \eta$ is a smooth loop in \mathbb{R}^2 that never passes through the origin, so it has a well defined winding number $w(\eta, \lambda) \in \mathbb{Z}$. The following is proved in [HWZ95a], Sec. 3.

Proposition 4.2.10. *Let $S(t)$ be a smooth 1-periodic loop of symmetric 2-by-2 matrices and define the operator $\mathbf{A}_S : H^1(S^1, \mathbb{R}^2) \rightarrow L^2(S^1, \mathbb{R}^2)$ as in (4.2.2). Then:*

1. *If η_1 and η_2 are eigenfunctions with the same eigenvalue λ , then $w(\eta_1, \lambda) = w(\eta_2, \lambda)$. Thus we can omit the eigenfunction and define $w(\lambda)$ for any $\lambda \in \sigma(\mathbf{A}_S)$.*
2. *For every $k \in \mathbb{Z}$, there are exactly two eigenvalues $\lambda_1, \lambda_2 \in \sigma(\mathbf{A}_S)$ (counting multiplicity) such that $w(\lambda_1) = w(\lambda_2) = k$.*
3. *Given two eigenvalues with $\lambda_1 \leq \lambda_2$, we have $w(\lambda_1) \leq w(\lambda_2)$.*

Note that any eigenvalue $\lambda \in \sigma(\mathbf{A}_S)$ has multiplicity at most 2. We now associate with the loop S two integers:

$$\alpha(S) = \max\{w(\lambda) \mid \lambda < 0\}, \quad (4.2.5)$$

and

$$p(S) = \begin{cases} 0 & \text{if there exist } \lambda_1 < 0 \text{ and } \lambda_2 \geq 0 \text{ with } w(\lambda_1) = w(\lambda_2) \\ 1 & \text{otherwise} \end{cases} \quad (4.2.6)$$

The number $p(S)$ is called the *parity* of \mathbf{A}_S . For an asymptotic operator \mathbf{A}_z with trivialization Φ , we shall denote these integers by $\alpha^\Phi(z)$ and $p^\Phi(z)$. The importance of α and p derives from the following result proved in [HWZ95a]:

Proposition 4.2.11. *If \mathbf{A}_S is nondegenerate, then*

$$\mu_{CZ}(\mathbf{A}_S) = 2\alpha(S) + p(S).$$

In the degenerate case we must consider the perturbed operators $\mathbf{A}_S^\pm = \mathbf{A}_S \pm \epsilon$; then

$$\mu_{CZ}(\mathbf{A}_S^\pm) = 2\alpha_\pm(S) + p_\pm(S),$$

where $\alpha_\pm(S)$ and $p_\pm(S)$ are defined as in (4.2.5) and (4.2.6) with all eigenvalues assumed to be eigenvalues of \mathbf{A}_S^\pm . It will be useful later on to note that for any eigenfunction η of \mathbf{A}_S with negative eigenvalue,

$$\text{wind}(\eta) \leq \alpha(S) \leq \alpha_-(S). \quad (4.2.7)$$

This follows from Prop. 4.2.10. Similarly we can bound the winding number from below if η has a positive eigenvalue. Let λ be the smallest positive eigenvalue of \mathbf{A}_S ; then $\lambda + \epsilon \geq \lambda_\epsilon$, where λ_ϵ is the smallest positive eigenvalue of \mathbf{A}_S^+ . If $p_+(S) = 0$, there is a pair of positive and negative eigenfunctions of \mathbf{A}_S^+ with the same winding number, so the winding of any positive eigenfunction of \mathbf{A}_S is at least $\alpha_+(S)$. In the case $p_+(S) = 1$, every positive eigenfunction of \mathbf{A}_S^+ winds at least once more than any negative eigenfunction, giving the lower bound $\alpha_+(S) + 1$. Thus

$$\text{wind}(\eta) \geq \alpha_+(S) + p_+(S). \quad (4.2.8)$$

These are not the strictest bounds that can be obtained, but they will be useful in relating these winding numbers to the Conley-Zehnder index. Note that we're not requiring \mathbf{A}_S to be nondegenerate.

4.2.3 Morse-Bott asymptotics

The definition of $\mu(\tilde{u})$ fits into the context of bundles with boundary data as follows. Recall that every periodic orbit $P \subset M$ with period $T > 0$ and a parametrization $x : S^1 \rightarrow M$ has an associated asymptotic operator $\mathbf{A}_x : H^1(x^*\xi) \rightarrow L^2(x^*\xi)$, defined by

$$\mathbf{A}_x = -J(\nabla_t - T\nabla X_\lambda),$$

where ∇ is any symmetric connection on M . It is shown in Appendix A that this expression gives a well defined section of $x^*\xi$ and does not depend on the choice of ∇ . Then given any periodic orbit $P \subset M$ and a trivialization Φ of $x^*\xi \rightarrow S^1$ for some parametrization $x : S^1 \rightarrow P$, there are two *perturbed Conley-Zehnder indices*

$$\mu_{CZ}^{\Phi, \pm}(P) := \mu_{CZ}^{\Phi}(\mathbf{A}_x^{\pm}), \quad (4.2.9)$$

which clearly do not depend on the chosen parametrization. If P is nondegenerate then both of these match $\mu_{CZ}^{\Phi}(P)$.

We can now generalize the discussion from Sec. 4.2.1 somewhat and consider a solution $\tilde{u} = (a, u) : \dot{\Sigma} \rightarrow \mathbb{R} \times M$ to Problem **(BP)** with asymptotic limits that either are nondegenerate or belong to simple Morse-Bott submanifolds. Then by the asymptotic description in Theorem A.2.2, the map $u : \dot{\Sigma} \rightarrow M$ extends continuously to a map $\bar{u} : \bar{\Sigma} \rightarrow M$, with each of the circles δ_z for $z \in \Gamma$ defining a smooth positively oriented parametrization

$$x_z = \bar{u}|_{\delta_z} : \delta_z \rightarrow M$$

of the corresponding asymptotic orbit. (The special orientation of δ_z is defined so that this should be true.) Thus the bundle $u^*\xi \rightarrow \dot{\Sigma}$ extends continuously to a bundle $E = \bar{u}^*\xi \rightarrow \bar{\Sigma}$ with smooth restrictions $E|_{\delta_z} = x_z^*\xi$, and we take \mathbf{A}_{x_z} as the asymptotic operator at $z \in \Gamma$. The transverse intersection $\xi \cap TL$ defines a totally real subbundle ℓ over $\partial\Sigma$. Putting all of this together to define boundary data $\mathcal{B}_{\bar{u}}$ for the bundle $\bar{u}^*\xi$, we set

$$\mu(\tilde{u}) = \mu(\bar{u}^*\xi, \mathcal{B}_{\bar{u}}). \quad (4.2.10)$$

In the nondegenerate case this just reiterates the definition in (4.2.1), but it's also well defined and quite useful in the Morse-Bott case. Note that the even/odd parity of each puncture $z \in \Gamma^{\pm}$ is now defined according to the parity of $\mu_{CZ}^{\Phi, \mp}(P)$ for the corresponding periodic orbit P .

Since we will be concerned primarily with finite energy foliations, we're particularly interested in solutions $\tilde{u} = (a, u) : \dot{\Sigma} \rightarrow \mathbb{R} \times M$ that are asymptotic to simple Morse-Bott families $L \subset M$ such that $u(\dot{\Sigma}) \cap L = \emptyset$. This is actually enough information to reach some very specific conclusions about $\mu(\tilde{u})$. Observe that any

Morse-Bott surface $L \subset M$ defines a natural section of ξ along L via the intersection $TL \cap \xi$.

Proposition 4.2.12. *Let $L \subset M$ be a 2-dimensional simple Morse-Bott manifold, and let Φ be the natural trivialization of ξ along L defined by the intersection $TL \cap \xi$. Then one of the following alternatives is true:*

(i) *For all periodic orbits $P \subset L$, $\mu_{CZ}^{\Phi,+}(P) = 0$ and $\mu_{CZ}^{\Phi,-}(P) = 1$.*

(ii) *For all periodic orbits $P \subset L$, $\mu_{CZ}^{\Phi,+}(P) = -1$ and $\mu_{CZ}^{\Phi,-}(P) = 0$.*

Proof. Let $P \subset L$ be a closed orbit with period $T > 0$, parametrized by $x : S^1 \rightarrow L$. By assumption, if $\Phi_\lambda^t : M \rightarrow M$ is the Reeb flow and $p = x(0)$, then $(d\Phi_\lambda^T(p) - \text{Id})|_{\xi_p} : \xi_p \rightarrow \xi_p$ has a 1-dimensional kernel equal to $T_p L \cap \xi_p$. Thus $\mathbf{A}_x : H^1(x^*\xi) \rightarrow L^2(x^*\xi)$ also has a 1-dimensional kernel, spanned by a section $e_0 : S^1 \rightarrow \xi$ with $\text{wind}^\Phi(e_0) = 0$. So by Prop. 4.2.10, there is one other eigenfunction e_1 of \mathbf{A}_x with $\text{wind}^\Phi(e_1) = 0$, and with eigenvalue $\lambda_1 \neq 0$. The alternative described above will depend on whether this eigenvalue is positive or negative. Note that e_0 and e_1 are also both eigenfunctions of the perturbed operators \mathbf{A}_x^\pm , with eigenvalues $\lambda_0^\pm = \pm\epsilon$ and $\lambda_1^\pm = \lambda_1 \pm \epsilon$ respectively.

If $\lambda_1 < 0$, then $\lambda_1^\pm < 0$. So $\lambda_0^+ > 0$ implies $\alpha_+^\Phi(P) = \text{wind}^\Phi(e_1) = 0$ and $p_+^\Phi(P) = 0$, thus $\mu_{CZ}^{\Phi,+}(P) = 2\alpha_+^\Phi(P) + p_+^\Phi(P) = 0$ by Prop. 4.2.11. Likewise $\lambda_0^- < 0$ implies $\alpha_-^\Phi(P) = \text{wind}^\Phi(e_0) = 0$ and $p_-^\Phi(P) = 1$, so $\mu_{CZ}^{\Phi,-}(P) = 1$.

If $\lambda_1 > 0$ then also $\lambda_1^\pm > 0$, and $\lambda_0^+ > 0$ is the smallest positive eigenvalue of \mathbf{A}_x^+ . Thus the largest negative eigenvalue has winding number $\alpha_+^\Phi(P) = \text{wind}^\Phi(e_0) - 1 = -1$, and $p_+^\Phi(P) = 1$, so $\mu_{CZ}^{\Phi,+}(P) = -1$. Finally, $\lambda_0^- < 0$ is the largest negative eigenvalue of \mathbf{A}_x^- , giving $\alpha_-^\Phi(P) = \text{wind}^\Phi(e_0) = 0$ and $p_-^\Phi(P) = 0$, thus $\mu_{CZ}^{\Phi,-}(P) = 0$. \square

Definition 4.2.13. *We define the sign of a simple Morse-Bott surface $L \subset M$ as positive if alternative (i) holds in Prop. 4.2.12, else negative.*

This terminology is motivated by the following result.

Theorem 4.2.14. *Let $\tilde{u} = (a, u) : \dot{\Sigma} \rightarrow M$ be a solution to Problem (BP), asymptotic at $z \in \Gamma$ to an orbit $P \subset L$, where L is a simple Morse-Bott surface, and assume there is a neighborhood \mathcal{U} of z in Σ such that for every circle $C \subset \mathcal{U}$ around z , the loop $u(C)$ does not wind around P with respect to the framing determined by L . Then the puncture z is odd, and its sign matches the sign of L .*

Proof. By Theorem A.2.2, the asymptotic behavior of u at z is described by an eigenfunction $e : \delta_z \rightarrow \xi$ of the asymptotic operator \mathbf{A}_z , with an eigenvalue λ whose

sign is *opposite* that of the puncture. The assumption that $u(\mathcal{U} \setminus \{z\})$ does not intersect L can only hold if e has the same winding number as the kernel of \mathbf{A}_z . Thus λ is precisely the eigenvalue mentioned in the proof of Prop. 4.2.12, whose sign determines (inversely) the sign of L . We conclude now from Prop. 4.2.12, using the natural trivialization of ξ along L , that $\mu_{CZ}^{\Phi,-}(P) = 1$ in the positive case and $\mu_{CZ}^{\Phi,+}(P) = -1$ in the negative case. \square

A sufficient condition for applying Theorem 4.2.14 is that $u(\mathcal{U} \setminus \{z\}) \cap L = \emptyset$. This has obvious applications to the study of finite energy foliations of stable Morse-Bott type. In particular we note that a given simple Morse-Bott surface can be only a positive or negative asymptotic limit for leaves of a foliation, not both.

4.3 Estimating $\text{wind}_\pi(\tilde{u})$

Given a solution $\tilde{u} = (a, u)$ of **(BP)**, when can we conclude that $u : \dot{\Sigma} \rightarrow M$ is an immersion? This is best understood in terms of the integer $\text{wind}_\pi(\tilde{u})$, which was introduced for finite energy surfaces in [HWZ95a]. To define it, note that the Cauchy-Riemann equation $T\tilde{u} \circ j = \tilde{J} \circ T\tilde{u}$ can be written in the form

$$\begin{aligned} u^* \lambda \circ j &= da, \\ \pi_\lambda \circ Tu \circ j &= J \circ \pi_\lambda \circ Tu. \end{aligned} \tag{4.3.1}$$

Here $\pi_\lambda : TM \rightarrow \xi$ is the fiberwise projection along X_λ . From the second equation, we see that there is a section of $\text{Hom}_{\mathbb{C}}(T\dot{\Sigma}, u^*\xi) \rightarrow \dot{\Sigma}$, which we will denote by πTu , defined at $z \in \dot{\Sigma}$ by

$$\pi Tu(z)v = \pi_\lambda \circ Tu(v) \in (u^*\xi)_z$$

for $v \in T_z\dot{\Sigma}$. Then it also follows from (4.3.1) that at any point $z \in \dot{\Sigma}$, $du(z) : T_z\dot{\Sigma} \rightarrow T_{u(z)}M$ fails to be injective if and only if $\pi Tu(z) = 0$. It was proved for finite energy surfaces in [HWZ95a] that the zeros of πTu are isolated and positive, and their algebraic count can be estimated in terms of the Conley-Zehnder index and genus of \tilde{u} . Extending this result to the case where Σ has boundary makes use of the assumption that our totally real submanifolds are tangent to X_λ .

As in Sec. 4.2, denote $L = \bigcup_{j=1}^m L_j$, where $\tilde{u}(\gamma_j) \subset \tilde{L}_j^\sigma$ are the boundary conditions for each connected component $\gamma_j \subset \partial\Sigma$, thus $u(\partial\Sigma) \subset L$. Now pick any $z \in \partial\Sigma$ and a tangent vector $Y \in T_z(\partial\Sigma)$. We have

$$\pi_\lambda \circ Tu(Y) = Tu(Y) - \lambda(Tu(Y)) \cdot X_\lambda(u(z)). \tag{4.3.2}$$

Since $X_\lambda(u(z)) \in T_{u(z)}L$, we conclude that $\pi Tu(z)Y$ lies in $TL \cap \xi$, which defines a one-dimensional totally real subbundle of $u^*\xi$ over $\partial\Sigma$. Call this subbundle $\ell \rightarrow \partial\Sigma$.

Then complex linearity defines a natural inclusion

$$\mathrm{Hom}_{\mathbb{R}}(T(\partial\Sigma), \ell) \hookrightarrow \mathrm{Hom}_{\mathbb{C}}(T\dot{\Sigma}, u^*\xi)|_{\partial\Sigma},$$

which also defines a totally real subbundle, and πTu satisfies the boundary condition $\pi Tu(\partial\Sigma) \subset \mathrm{Hom}_{\mathbb{R}}(T(\partial\Sigma), \ell)$.

Counting zeros on the boundary

We'll need some general topological notions about sections that satisfy this type of boundary condition. Let $(E, J) \rightarrow S$ be a topological complex line bundle over a compact, connected and oriented surface with boundary. Partition the boundary into disjoint subsets $\partial S = \partial_0 S \sqcup \partial_1 S$, either of which may be empty. As a motivating example, one can think of S as the circle compactification $\bar{\Sigma}$ of a punctured Riemann surface with boundary $\dot{\Sigma}$, with $\partial_0 S = \partial\Sigma$ and $\partial_1 S = \bigcup_{z \in \Gamma} \delta_z$. Now choose a totally real subbundle $\ell \subset E|_{\partial_0 S} \rightarrow \partial_0 S$, and consider the space of all continuous sections $\sigma : S \rightarrow E$ such that $\sigma(\partial_0 S) \subset \ell$ and $\sigma \neq 0$ on $\partial_1 S$. We will call such sections *admissible*. Suppose σ is an admissible section with a discrete zero set $Z(\sigma) \subset S$. If $z_0 \in Z(\sigma) \cap \mathrm{int} S$, then it is standard to define the *order* of the zero $o(z_0)$ as the winding number of σ over a small loop around z_0 , computed in any local trivialization. The boundary condition makes it possible to extend this definition to isolated zeros on the boundary as well: for $z_0 \in Z(\sigma) \cap \partial_0 S$, choose coordinates identifying a neighborhood \mathcal{U} of z_0 with $\mathbb{D}^+ = \{z \in \mathbb{C} \mid |z| \leq 1 \text{ and } \mathrm{Im} z \geq 0\}$, such that $z_0 = 0$ and $\mathcal{U} \cap \partial S = \mathbb{D}^+ \cap \mathbb{R}$. Choose also a local trivialization over \mathcal{U} that identifies ℓ with $(\mathbb{D}^+ \cap \mathbb{R}) \times \mathbb{R} \subset \mathbb{D}^+ \times \mathbb{C}$. Then σ is represented on this neighborhood by a continuous function $f : \mathbb{D}^+ \rightarrow \mathbb{C}$, satisfying the boundary condition $f(\mathbb{D}^+ \cap \mathbb{R}) \subset \mathbb{R}$. We can therefore extend f to a continuous function $f^D : \mathbb{D} \rightarrow \mathbb{C}$ on the full disk, satisfying $f^D(\bar{z}) = \overline{f^D(z)}$. By definition, the order $o(z_0)$ is then the order of the isolated zero of f^D at 0: i.e. the winding number of f^D for a small circle about 0. It is easy to verify that this definition doesn't depend on the choices.

For an admissible section σ with discrete zero set $Z(\sigma)$, we now define the algebraic count of zeros by

$$N(\sigma) = \sum_{z \in Z(\sigma) \cap \mathrm{int} S} o(z) + \frac{1}{2} \sum_{z \in Z(\sigma) \cap \partial_0 S} o(z).$$

This is a direct generalization of the case where $\partial_0 S = \emptyset$; the price of allowing zeros on the boundary is that in general, $N(\sigma)$ may be a half-integer.

Proposition 4.3.1. *Suppose σ_0 and σ_1 are admissible sections with isolated zeros, and are homotopic through a family of admissible sections. Then $N(\sigma_0) = N(\sigma_1)$.*

Proof. We prove this in two steps.

Step 1. Assume $\partial_0 S = \emptyset$. If $\partial_1 S$ is nonempty, then the following result is standard: $N(\sigma)$ equals the sum of the winding numbers of σ about the components of $\partial_1 S$, with respect to any global trivialization Φ . We'll denote this sum of winding numbers by $\text{wind}_{\partial_1 S}^\Phi(\sigma)$. Clearly this integer doesn't change under homotopies that remain nonzero on $\partial_1 S$. The result is also standard if $\partial_1 S = \partial_0 S = \emptyset$, for then S is closed and $N(\sigma)$ is simply the Euler number of the bundle $E \rightarrow S$.

Step 2. Assume $\partial_0 S$ is nonempty. Define the conjugate bundle $(E^c, J^c) \rightarrow S^c$ as in Sec. 4.2.2, where $J^c = -J$ and S^c is simply S with the opposite orientation. Then the bundles $E \rightarrow S$ and $E^c \rightarrow S^c$ can be glued together along the totally real subbundle $\ell \rightarrow \partial_0 S$, creating a new complex line bundle $(E^D, J^D) \rightarrow S^D$. The boundary of S^D is now $\partial S^D = \partial_1 S^D = \partial_1 S \sqcup (\partial_1 S)^c$, where $\partial_1 S$ and $(\partial_1 S)^c$ are identical manifolds with opposite orientations (they may also be empty). Any admissible section σ of E defines naturally a "conjugate" section σ^c of E^c , and these can be glued together to form an admissible section σ^D of E^D , to which the result of step 1 applies. Indeed, a homotopy σ_t of admissible sections of E yields a homotopy σ_t^D on E^D , thus it will suffice to prove the following formula relating $N(\sigma)$ to $N(\sigma^D)$:

$$N(\sigma^D) = \sum_{z \in Z(\sigma^D)} o(z) = 2 \sum_{z \in Z(\sigma) \cap \text{int } S} o(z) + \sum_{z \in Z(\sigma) \cap \partial_0 S} o(z) = 2N(\sigma).$$

This follows from two important facts which are easy to check: first, if z is an interior zero of σ , its order is the same as that of z^c for σ^c . This is due to the combination of complex conjugation and orientation reversal, which cancel each other out in computing the winding around z^c . Secondly, if z is a boundary zero of σ , then its order equals its order as an interior zero of σ^D . To see this, choose coordinates identifying a neighborhood \mathcal{U} of $z \in S$ with \mathbb{D}^+ , and a local trivialization $\Phi : E|_{\mathcal{U}} \rightarrow \mathbb{D}^+ \times \mathbb{C}$ such that $\Phi(\ell|_{\mathcal{U} \cap \partial_0 S}) \subset (\mathbb{D}^+ \cap \mathbb{R}) \times \mathbb{R}$. This defines a complex conjugate trivialization Φ^c of $E^c|_{\mathcal{U}^c}$, which can be glued to Φ , forming a local trivialization Φ^D of E^D over a neighborhood of $z \in S^D$. Expressing σ^D in this trivialization near z , we find that it matches the "Schwartz reflection" that we used to define $o(z)$ above. \square

Observe that one can combine a homotopy of an admissible section σ with a homotopy of the totally real boundary condition $\ell \subset E$. An easy variation on the doubling argument above then shows that $N(\sigma)$ is invariant under such changes.

If $\partial_1 S \neq \emptyset$, then $N(\sigma)$ can be computed in terms of winding numbers around $\partial_1 S$ and the Maslov index of the bundle pair (E, ℓ) .

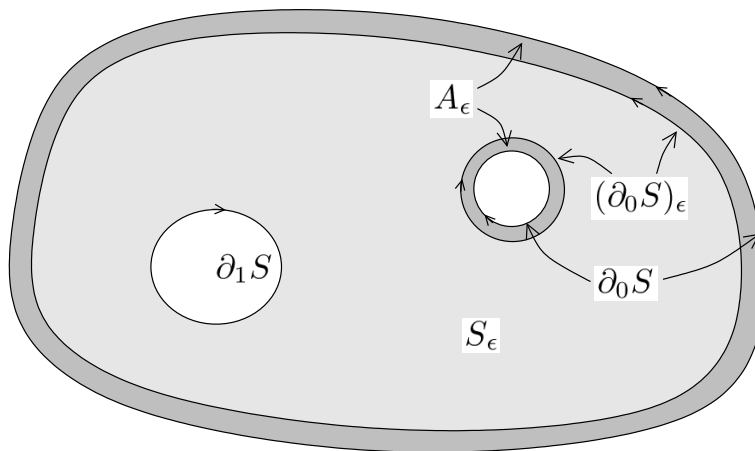

Figure 4.1: The partition $S = S_\epsilon \cup A_\epsilon$.

Proposition 4.3.2. *Assume $\partial_1 S \neq \emptyset$. Then for any admissible section $\sigma : S \rightarrow E$ with isolated zeros and any trivialization $\Phi : E \rightarrow S \times \mathbb{C}$,*

$$N(\sigma) = \text{wind}_{\partial_1 S}^\Phi(\sigma) + \frac{1}{2}\mu^\Phi(E, \ell).$$

Proof. Choose a compact neighborhood A_ϵ of $\partial_0 S$ in S and an orientation preserving homeomorphism $\varphi : [-\epsilon, 0] \times \partial_0 S \rightarrow A_\epsilon$ such that $\varphi(\{0\} \times \partial_0 S) = \partial_0 S$. Then $\partial A_\epsilon = \partial_0 S \cup -(\partial_0 S)_\epsilon$ where $(\partial_0 S)_\epsilon = \varphi(\{-\epsilon\} \times \partial_0 S)$ is a collection of circles “parallel” to $\partial_0 S$, with matching orientation (Figure 4.1). Denote $S_\epsilon = S \setminus A_\epsilon$, so $\partial S_\epsilon = (\partial_0 S)_\epsilon \cup \partial_1 S$. We can arrange that all interior zeros of σ are contained in S_ϵ , so then

$$\sum_{z \in Z(\sigma) \cap \text{int } S} o(z) = \text{wind}_{(\partial_0 S)_\epsilon}^\Phi(\sigma) + \text{wind}_{\partial_1 S}^\Phi(\sigma). \quad (4.3.3)$$

To count the zeros on the boundary, construct the double $E^D \rightarrow S^D$ by gluing E to its opposite along the real subbundle $\ell \rightarrow \partial_0 S$, and extend σ in the natural way to a section $\sigma^D : S^D \rightarrow E^D$. Restricting to $A_\epsilon \subset S$, the trivialization Φ can also be extended (though not naturally) over $A_\epsilon^D \subset S^D$. Note that $\partial A_\epsilon^D = -(\partial_0 S)_\epsilon \cup -(\partial_0 S)_\epsilon^c$, thus using the extended trivialization Φ ,

$$\sum_{z \in Z(\sigma) \cap \partial_0 S} o(z) = -\text{wind}_{(\partial_0 S)_\epsilon}^\Phi(\sigma) - \text{wind}_{(\partial_0 S)_\epsilon^c}^\Phi(\sigma^c). \quad (4.3.4)$$

(We’re using the convention that $(\partial_0 S)_\epsilon$ and $(\partial_0 S)_\epsilon^c$ have *opposite* orientations.) To compute this, we shall first identify A_ϵ^D with $[-\epsilon, \epsilon] \times \partial_0 S$. More precisely,

let $\psi : S \rightarrow S^c$ be the natural orientation reversing homeomorphism, and define $\varphi^D : [-\epsilon, \epsilon] \times \partial_0 S \rightarrow A_\epsilon^D$ by

$$\varphi^D(s, t) = \begin{cases} \varphi(s, t) & \text{if } s \leq 0 \\ \psi \circ \varphi(-s, t) & \text{if } s \geq 0 \end{cases}$$

Now choose a connected component $\gamma \subset \partial_0 S$ and identify it with S^1 , so we can use the coordinates $(s, t) \in [-\epsilon, \epsilon] \times S^1 \subset S^D$ for points in a neighborhood of γ . Let $\gamma_\epsilon = \{-\epsilon\} \times S^1$ be the corresponding component of $(\partial_0 S)_\epsilon$. Suppose $\text{wind}_{\gamma_\epsilon}^\Phi(\sigma) = k$ and $\mu^\Phi(E|_\gamma, \ell|_\gamma) = q$, and let $\Phi_2 : E|_{[-\epsilon, 0] \times S^1} \rightarrow \mathbb{C}$ be the projection of the trivialization $\Phi : E|_{[-\epsilon, 0] \times S^1} \rightarrow ([-\epsilon, 0] \times S^1) \times \mathbb{C}$ to the second factor. Then after homotopies of σ and ℓ , we may assume

$$\begin{aligned} \Phi_2(\sigma(-\epsilon, t)) &= e^{2\pi i k t}, \\ \Phi_2(\ell_{(0, t)}) &= e^{\pi i q t} \mathbb{R}. \end{aligned}$$

We now construct explicitly an extension of Φ over $[0, \epsilon] \times S^1$. Let $K : E \rightarrow E^c$ be the natural complex antilinear bundle map covering $\psi : S \rightarrow S^c$, and define for $(s, t) \in [0, \epsilon] \times S^1$,

$$\Phi^{-1}(s, t, V) = K \circ \Phi^{-1}(-s, t, e^{2\pi i q t} \bar{V}) \quad (4.3.5)$$

This defines a continuous trivialization of E^D over $[-\epsilon, \epsilon] \times S^1 \subset S^D$. Now, since by definition $\sigma^c(s, t) = K \circ \sigma(-s, t)$ for $s \in [0, \epsilon]$, we have $\Phi^{-1}(\epsilon, t, \Phi_2(\sigma^c(\epsilon, t))) = \sigma^c(\epsilon, t) = K \circ \Phi^{-1}(-\epsilon, t, e^{2\pi i k t})$, and using (4.3.5) we compute, $\Phi_2(\sigma^c(\epsilon, t)) = e^{2\pi i(q-k)t}$. Thus the algebraic count of zeros on $[-\epsilon, \epsilon] \times S^1$ is

$$-\text{wind}_{\{-\epsilon\} \times S^1}^\Phi(\sigma) + \text{wind}_{\{\epsilon\} \times S^1}^\Phi(\sigma^c) = -k + (q - k) = q - 2k.$$

Adding these up over all components of $\partial_0 S$, we get

$$\sum_{z \in Z(\sigma) \cap \partial_0 S} o(z) = \mu^\Phi(E, \ell) - 2 \text{wind}_{(\partial_0 S)_\epsilon}^\Phi(\sigma).$$

Combined with (4.3.3), this yields

$$\begin{aligned} 2N(\sigma) &= 2 \sum_{z \in Z(\sigma) \cap \text{int } S} o(z) + \sum_{z \in Z(\sigma) \cap \partial_0 S} o(z) \\ &= (2 \text{wind}_{(\partial_0 S)_\epsilon}^\Phi(\sigma) + 2 \text{wind}_{\partial_1 S}^\Phi(\sigma)) + (\mu^\Phi(E, \ell) - 2 \text{wind}_{(\partial_0 S)_\epsilon}^\Phi(\sigma)) \\ &= 2 \text{wind}_{\partial_1 S}^\Phi(\sigma) + \mu^\Phi(E, \ell). \end{aligned}$$

□

Remark 4.3.3. For the special case in which the real line bundle $\ell \rightarrow \partial_0 S$ is orientable, one can argue more simply as follows: there exists a trivialization $\Phi : E \rightarrow S \times \mathbb{C}$ such that $\Phi(\ell) = \partial_0 S \times \mathbb{R}$. This can be glued to the complex conjugate trivialization $\Phi^c : E^c \rightarrow S^c \times \mathbb{C}$, forming a global trivialization $\Phi^D : E^D \rightarrow S^D \times \mathbb{C}$, and one easily verifies that

$$\text{wind}_{\partial_1 S}^\Phi(\sigma) = \text{wind}_{(\partial_1 S)^c}^{\Phi^c}(\sigma^c),$$

thus $2N(\sigma) = N(\sigma^D) = \text{wind}_{\partial_1 S^D}^{\Phi^D}(\sigma^D) = 2 \text{wind}_{\partial_1 S}^\Phi(\sigma)$. This matches the result of Prop. 4.3.2 since $\mu^\Phi(E, \ell) = 0$ for the particular trivialization chosen. Note that in this case, $N(\sigma)$ is always an integer. This is related to the familiar fact that any generic real-valued function on the circle has an even number of zeros.

Application to $\text{wind}_\pi(\tilde{u})$

We return to the topic of estimating the number of zeros of the section πTu of $\text{Hom}_{\mathbb{C}}(T\tilde{\Sigma}, u^*\xi) \rightarrow \tilde{\Sigma}$. To understand the nature of the zero set, we apply the similarity principle: this is often used to prove that functions satisfying Cauchy-Riemann type equations have isolated zeros, as a corollary of the same fact for analytic functions.

In the following, $\mathcal{L}_{\mathbb{R}}(\mathbb{C}^n)$ (or $\mathcal{L}_{\mathbb{C}}(\mathbb{C}^n)$) denotes the space of real (or complex) linear maps of \mathbb{C}^n to itself, and we write

$$\begin{aligned} \mathbb{D}^+ &= \{z \in \mathbb{C} \mid |z| \leq 1, \text{Im } z \geq 0\}, \\ \mathcal{D}^+ &= \{z \in \mathbb{D}^+ \mid |z| < 1\}. \end{aligned}$$

Proposition 4.3.4 (The Similarity Principle).

(i) Assume $A \in L^\infty(\mathbb{D}, \mathcal{L}_{\mathbb{R}}(\mathbb{C}^n))$, $2 < p < \infty$ and $w \in W_{\text{loc}}^{1,p}(\mathbb{D}, \mathbb{C}^n)$ solves

$$\partial_s w + i\partial_t w + Aw = 0 \quad \text{in} \quad \text{int } \mathbb{D}$$

with $w(0) = 0$. Then there is a map

$$\Phi \in \bigcap_{2 < q < \infty} W^{1,q}(\mathbb{D}, \text{GL}(n, \mathbb{C}))$$

with $\Phi(0) = \mathbb{1}$, and a map $f : \mathbb{D} \rightarrow \mathbb{C}^n$ which is holomorphic on a neighborhood of 0, such that $f(0) = 0$ and

$$w(z) = \Phi(z)f(z).$$

(ii) Assume $A \in L^\infty(\mathbb{D}^+, \mathcal{L}_\mathbb{R}(\mathbb{C}^n))$, $2 < p < \infty$ and $w \in W_{\text{loc}}^{1,p}(\mathcal{D}^+, \mathbb{C}^n)$ solves

$$\begin{aligned} \partial_s w + i\partial_t w + Aw &= 0 & \text{in } \text{int } \mathbb{D}^+ \\ w(\mathcal{D}^+ \cap \mathbb{R}) &\subset \mathbb{R}^n \end{aligned}$$

with $w(0) = 0$. Then there is a map

$$\Phi \in \bigcap_{2 < q < \infty} W^{1,q}(\mathbb{D}^+, \text{GL}(n, \mathbb{C}))$$

with $\Phi(0) = \mathbb{1}$ and $\Phi(\mathbb{D}^+ \cap \mathbb{R}) \subset \text{GL}(n, \mathbb{R}) \subset \text{GL}(n, \mathbb{C})$, and a map $f : \mathbb{D}^+ \rightarrow \mathbb{C}^n$ which is holomorphic on a neighborhood of 0 in \mathbb{D}^+ , such that $f(0) = 0$ and

$$w(z) = \Phi(z)f(z).$$

See [HZ94] for a proof of the interior version, and [A03] for the boundary version.

To apply this at the boundary, we need the following variation on Darboux's theorem.

Lemma 4.3.5. *Let (M, λ) be a three-dimensional contact manifold, and $L \subset M$ an embedded surface tangent to the Reeb vector field. Then any point $p \in L$ is contained in a neighborhood $\mathcal{U} \subset M$ with coordinates (x, y, z) such that $\lambda = dz + x dy$, $p = (0, 0, 0)$ and $L \cap \mathcal{U} = \{y = 0\}$.*

Proof. Let $\gamma : (-\epsilon, \epsilon) \rightarrow M$ be a smooth Legendrian curve with $\gamma(0) = p$ and $\gamma(t) \in L$ for all t ; the curve is unique up to parametrization. Choose any vector field η transverse to L along $\gamma(t)$, and add multiples of $X_\lambda(\gamma(t))$ so that η satisfies $\lambda(\eta(\gamma(t))) = t$. Then for (x, y, z) in a neighborhood of $0 \in \mathbb{R}^3$, we define the embedding

$$\varphi(x, y, z) = \Phi_\lambda^z(\exp_{\gamma(x)}[y\eta(\gamma(x))]),$$

where the exponential map is defined with respect to any metric on M , and Φ_λ^t is the Reeb flow. This defines coordinates near p in which $L = \{y = 0\}$ and $\partial_z \equiv X_\lambda$, hence $\lambda(\partial_z) \equiv 1$. For the coordinate vector ∂_x along L , we have

$$\lambda(\partial_x) = \lambda\left(\frac{\partial}{\partial x}\Phi_\lambda^z(\gamma(x))\right) = \lambda((\Phi_\lambda^z)_*\dot{\gamma}(x)) = 0$$

since γ is Legendrian and $(\Phi_\lambda^z)_*$ preserves ξ . Likewise along L ,

$$\lambda(\partial_y) = \lambda\left(\frac{\partial}{\partial y}\Phi_\lambda^z(\exp_{\gamma(x)}[y\eta(\gamma(x))])\Big|_{y=0}\right) = \lambda((\Phi_\lambda^z)_*\eta(\gamma(x))) = \lambda(\eta(\gamma(x))) = x,$$

where the last step uses $L_{X_\lambda}\lambda \equiv 0$.

By these considerations, we may assume without loss of generality that

$$M = \mathbb{R}^3, \quad L = \{y = 0\}, \quad p = (0, 0, 0),$$

and

$$\lambda|_L = \lambda_0|_L, \quad X_\lambda \equiv X_{\lambda_0} \equiv \partial_z$$

where $\lambda_0 = dz + xdy$. The new coordinates will be constructed by a Moser deformation argument. Define a smooth family of 1-forms by $\lambda_t = t\lambda + (1-t)\lambda_0$; these are contact forms near L , and they all have the same Reeb vector field. We seek a time dependent vector field Y_t whose flow φ_t is defined in a neighborhood of p for $t \in [0, 1]$ and satisfies

$$\varphi_t^*\lambda_t = \lambda_0. \quad (4.3.6)$$

It turns out that in this case we can get away with assuming $Y_t \in \xi_t = \ker \lambda_t$. Then denoting $\dot{\lambda}_t = \frac{d}{dt}\lambda_t$, (4.3.6) is satisfied if

$$0 = \frac{d}{dt}\varphi_t^*\lambda_t = \varphi_t^*(L_{Y_t}\lambda_t + \dot{\lambda}_t) = \varphi_t^*(d\iota_{Y_t}\lambda_t + \iota_{Y_t}d\lambda_t + \dot{\lambda}_t),$$

which is equivalent to $d\lambda_t(Y_t, \cdot)|_{\xi_t} = -\dot{\lambda}_t|_{\xi_t}$. This determines a unique vector field Y_t , which vanishes on L , thus the flow is indeed defined near p and preserves L . The desired coordinate system is provided by φ_1 . \square

Proposition 4.3.6. *Let $\tilde{u} = (a, u) : \dot{\Sigma} \rightarrow \mathbb{R} \times M$ be a solution to Problem (BP). Then if πTu is not identically zero, it has finitely many zeros, all with positive order.*

Proof. The main task is to prove that either πTu vanishes identically or else all of its zeros are isolated. Indeed, suppose $\pi Tu(\zeta_0) = 0$ and $\zeta_0 \in \partial\Sigma$. Choosing holomorphic coordinates $(s, t) = s + it \in \mathbb{D}^+$ near ζ_0 and the coordinates of Lemma 4.3.5 near $u(\zeta_0) \in L \subset M$, we write

$$\tilde{u} = (a, u) : \mathbb{D}^+ \rightarrow \mathbb{R}^3 : (s, t) \mapsto (a(s, t), x(s, t), y(s, t), z(s, t)),$$

with $\lambda = dz + xdy$, $X_\lambda \equiv \partial_z$, $u(0, 0) = (0, 0, 0)$ and $y(s, 0) = 0$. For $(s, t) \in \mathbb{D}^+$, we shall express the complex linear map $\pi Tu(s, t) : T_{(s,t)}\mathbb{D}^+ \rightarrow \xi_{u(s,t)}$ in terms of the trivialization of ξ provided by the vector fields

$$v_1 = \partial_x, \quad v_2 = \partial_y - x\partial_z.$$

For any vector $Y = Y^1\partial_x + Y^2\partial_y + Y^3\partial_z \in T_{(x,y,z)}M$, we have $\pi_\lambda Y = Y - \lambda(Y)X_\lambda(x, y, z) = Y^1v_1 + Y^2v_2$. Thus $\pi Tu(s, t)\partial_s = \pi_\lambda u_s(s, t) = x_s(s, t)v_1 + y_s(s, t)v_2$, and it will suffice to prove that the zero of

$$V : \mathbb{D}^+ \rightarrow \mathbb{C} : (s, t) \mapsto x_s(s, t) + iy_s(s, t)$$

at $(s, t) = (0, 0)$ is isolated. Denote $q(s, t) = x(s, t) + iy(s, t)$, so $V(s, t) = q_s(s, t)$.

Let $J(s, t)$ be the complex multiplication $J : \xi_{u(s,t)} \rightarrow \xi_{u(s,t)}$, expressed in the trivialization $\{v_1, v_2\}$ as a real 2-by-2 matrix with $[J(s, t)]^2 = -\mathbf{1}$. Then the nonlinear Cauchy-Riemann equation for \tilde{u} gives

$$q_s(s, t) + J(s, t)q_t(s, t) = 0,$$

where \mathbb{C} is identified with \mathbb{R}^2 so that multiplication by $J(s, t)$ makes sense. Differentiating this with respect to s , we find

$$V_s(s, t) + J(s, t)V_t(s, t) + [\partial_s J(s, t)]J(s, t)V(s, t) = 0,$$

and due to the boundary condition $y(s, 0) = 0$, $V(s, 0) \in \mathbb{R}$ for all s . Define a smooth matrix valued function $G : \mathbb{D}^+ \rightarrow \mathrm{GL}(2, \mathbb{R})$ by

$$G(s, t) = (e_1 \quad J(s, t)e_1), \quad \text{where } e_1 = \begin{pmatrix} 1 \\ 0 \end{pmatrix}.$$

Then $G(s, 0)$ preserves \mathbb{R} , and $[G(s, t)]^{-1}J(s, t)G(s, t) = i$. The map $\tilde{V}(s, t) := [G(s, t)]^{-1}V(s, t)$ then satisfies $\tilde{V}(s, 0) \in \mathbb{R}$ and an equation of the form

$$\tilde{V}_s(s, t) + i\tilde{V}_t(s, t) + A(s, t)\tilde{V}(s, t) = 0$$

for some smooth matrix-valued function $A(s, t)$. We can thus apply the similarity principle and write

$$V(s, t) = G(s, t)\Phi(s, t)f(s, t),$$

where $f : \mathbb{D}^+ \rightarrow \mathbb{C}$ is analytic on a neighborhood of 0, with $f(\mathbb{D}^+ \cap \mathbb{R}) \subset \mathbb{R}$. Moreover, $G(s, t)\Phi(s, t)$ can be assumed arbitrarily close to the constant invertible matrix $G(0, 0)$ along some small semicircle about 0. It follows that unless V vanishes identically on a neighborhood of 0, the zero is isolated, and its order equals the order of the zero for f . The latter is well defined and always positive, by the Schwartz reflection principle.

A similar argument applies to interior zeros of πTu , using any Darboux chart. This proves that all zeros are isolated.

The result now follows from the asymptotic description of \tilde{u} given in Appendix A; the map $u : \dot{\Sigma} \rightarrow M$ is always an immersion in some neighborhood of the punctures. Thus the zeros of πTu are confined to a compact subset of $\dot{\Sigma}$. \square

Given a solution $\tilde{u} = (a, u) : \dot{\Sigma} \rightarrow \mathbb{R} \times M$ of **(BP)** with πTu not identically zero, we define the nonnegative number $\mathrm{wind}_\pi(\tilde{u})$ by

$$\mathrm{wind}_\pi(\tilde{u}) = \sum_{z \in \mathrm{int} \dot{\Sigma}, \pi Tu(z)=0} o(z) + \frac{1}{2} \sum_{z \in \partial \Sigma, \pi Tu(z)=0} o(z),$$

This generalizes the definition given in [HWZ95a], with the new feature that $\text{wind}_\pi(\tilde{u})$ may be a half-integer if πTu has zeros on the boundary. The name is motivated by the fact that if $\dot{\Sigma} = \mathbb{C}$, $\text{wind}_\pi(\tilde{u})$ is simply the winding number of πTu around a large circle with respect to a global trivialization.

The following is the main result of this section. Note that the solution \tilde{u} may have Morse-Bott asymptotic limits—they need not be nondegenerate.

Theorem 4.3.7. *Let $\tilde{u} : \dot{\Sigma} \rightarrow \mathbb{R} \times M$ be a solution to (BP), and assume πTu is not identically zero. Then*

$$0 \leq 2 \text{wind}_\pi(\tilde{u}) \leq \mu(\tilde{u}) - 2\chi(\Sigma) + 2(\#\Gamma_0) + \#\Gamma_1.$$

Proof. Choose a smooth vector field $Y \in \text{Vec}(\dot{\Sigma})$ with the following properties:

- (i) Y has only nondegenerate zeros, and its zero set is disjoint from that of πTu ,
- (ii) in cylindrical coordinates $(s, t) \in Z^\pm$ near each puncture, $Y(s, t) = \frac{\partial}{\partial s}$,
- (iii) at $\partial\Sigma$, Y is nonzero and tangent to $\partial\Sigma$.

Clearly the zero set $Z(Y)$ is finite, and we claim that the algebraic count of zeros $N(Y) = \chi(\dot{\Sigma})$. Indeed, one can deform Y slightly near the punctures to obtain a vector field \bar{Y} on $\bar{\Sigma}$ which is nonzero on $\partial\bar{\Sigma}$. Then for each component of $\partial\bar{\Sigma}$, glue on a disk to obtain a closed surface Σ_1 . The vector field \bar{Y} extends to $Y_1 \in \text{Vec}(\Sigma_1)$ with one new zero of order $+1$ on each added disk, so if $\partial\bar{\Sigma}$ has p components, $N(Y_1) = N(\bar{Y}) + p = \chi(\Sigma_1) = \chi(\bar{\Sigma}) + p$, which proves the claim.

There is a smooth section $\sigma_Y : \Sigma \rightarrow u^*\xi$ defined by $\sigma_Y(z) = \pi Tu(z)Y(z)$, which has finitely many nondegenerate zeros and, by (4.3.2), satisfies the totally real boundary condition $\sigma_Y(z) \in \ell_z = \xi_{u(z)} \cap T_{u(z)}L$ for $z \in \partial\Sigma$. Thus the algebraic zero count $N(\sigma_Y) \in \frac{1}{2}\mathbb{Z}$ is well defined, and we have $N(\sigma_Y) = N(\pi Tu) + N(Y) = N(\pi Tu) + \chi(\dot{\Sigma})$. Prop. 4.3.2 can be used to calculate $N(\sigma_Y)$, once the asymptotic behavior of σ_Y is understood. The latter was analyzed in [HWZ95a] (in the proof of Theorem 2.3). To reiterate briefly, using cylindrical coordinates $(s, t) \in Z^\pm$ in a neighborhood of a puncture $z \in \Gamma^\pm$, we have

$$\frac{\sigma_Y(s, t)}{|\sigma_Y(s, t)|_J} \rightarrow \rho(t)e(t) \quad \text{as } s \rightarrow \pm\infty,$$

where $\rho : S^1 \rightarrow \mathbb{R}$ is a smooth positive function and $e \in C^\infty(\bar{u}^*\xi|_{\delta_z})$ is an eigenfunction of the asymptotic operator \mathbf{A}_z on $L^2(\bar{u}^*\xi|_{\delta_z})$ defined by the linearized Reeb flow. The corresponding eigenvalue is negative if and only if the puncture is positive,

and vice versa. Thus we can normalize σ_Y near the punctures and extend it as a section of $\bar{u}^*\xi \rightarrow \bar{\Sigma}$ with $\sigma_Y(\pm\infty, t) = e(t)$.

Choose a global unitary trivialization $\Phi : \bar{u}^*\xi \rightarrow \bar{\Sigma} \times \mathbb{C}$. The winding numbers $\text{wind}_{\delta_z}^\Phi(\sigma_Y)$ can now be related to the Conley-Zehnder indices $\mu_{\text{CZ}}^\Phi(\mathbf{A}_z^\pm)$ via Prop. 4.2.11: write $\mu_{\text{CZ}}^\Phi(\mathbf{A}_z^\pm) = 2\alpha_\pm^\Phi(z) + p_\pm^\Phi(z)$, where $\alpha_\pm^\Phi(z)$ is the winding number (with respect to Φ) of the eigenfunction of $\mathbf{A}_z^\pm = \mathbf{A}_z \pm \epsilon$ with the largest negative eigenvalue, and the parity $p_\pm^\Phi(z)$ is either 0 or 1. Then if z is a positive puncture, (4.2.7) gives

$$\text{wind}_{\delta_z}^\Phi(\sigma_Y) \leq \alpha_-^\Phi(z), \quad (4.3.7)$$

whereas using (4.2.8) for a negative puncture,

$$\begin{aligned} \text{wind}_{\delta_z}^\Phi(\sigma_Y) &\geq \alpha_+^\Phi(z) && \text{if } p_+^\Phi(z) = 0, \\ \text{wind}_{\delta_z}^\Phi(\sigma_Y) &\geq \alpha_+^\Phi(z) + 1 && \text{if } p_+^\Phi(z) = 1. \end{aligned} \quad (4.3.8)$$

Partition $\partial\bar{\Sigma}$ into the subsets $\partial_0\bar{\Sigma} = \partial\Sigma$ and

$$\partial_1\bar{\Sigma} = \left(\bigcup_{z \in \Gamma^+} \delta_z \right) \cup \left(\bigcup_{z \in \Gamma^-} (-\delta_z) \right),$$

recalling here that the special orientation of δ_z for a negative puncture is *opposite* the natural orientation of $\partial\bar{\Sigma}$. Then from (4.3.7) and (4.3.8) we compute,

$$\begin{aligned} 2 \text{wind}_{\partial_1\bar{\Sigma}}^\Phi(\sigma_Y) &= \sum_{z \in \Gamma^+} 2 \text{wind}_{\delta_z}^\Phi(\sigma_Y) - \sum_{z \in \Gamma^-} 2 \text{wind}_{\delta_z}^\Phi(\sigma_Y) \\ &\leq \sum_{z \in \Gamma^+} 2\alpha_-^\Phi(z) - \sum_{z \in \Gamma_0^-} 2\alpha_+^\Phi(z) - \sum_{z \in \Gamma_1^-} 2(\alpha_+^\Phi(z) + 1) \\ &= \sum_{z \in \Gamma^+} (2\alpha_-^\Phi(z) + p_-^\Phi(z)) - \#\Gamma_1^+ - \sum_{z \in \Gamma^-} (2\alpha_+^\Phi(z) + p_+^\Phi(z)) - \#\Gamma_1^- \\ &= \sum_{z \in \Gamma^+} \mu_{\text{CZ}}^\Phi(\mathbf{A}_z^-) - \sum_{z \in \Gamma^-} \mu_{\text{CZ}}^\Phi(\mathbf{A}_z^+) - \#\Gamma_1. \end{aligned}$$

Combining this inequality with Prop. 4.3.2 gives

$$\begin{aligned} 2N(\sigma_Y) &= 2 \text{wind}_{\partial_1\bar{\Sigma}}^\Phi(\sigma_Y) + \mu^\Phi(\bar{u}^*\xi, \ell) \\ &\leq \sum_{z \in \Gamma^+} \mu_{\text{CZ}}^\Phi(\mathbf{A}_z^-) - \sum_{z \in \Gamma^-} \mu_{\text{CZ}}^\Phi(\mathbf{A}_z^+) - \#\Gamma_1 + \mu^\Phi(\bar{u}^*\xi, \ell) = \mu(\tilde{u}) - \#\Gamma_1. \end{aligned}$$

Finally, $2 \text{wind}_\pi(\tilde{u}) = 2N(\pi T u) = 2N(\sigma_Y) - 2\chi(\dot{\Sigma}) \leq \mu(\tilde{u}) - \#\Gamma_1 - 2(\chi(\Sigma) - \#\Gamma) = \mu(\tilde{u}) - 2\chi(\Sigma) + \#\Gamma_1 + 2(\#\Gamma_0)$. \square

Corollary 4.3.8. *If $\tilde{u} = (a, u) : \dot{\Sigma} \rightarrow \mathbb{R} \times M$ is a solution to (BP) with $\mu(\tilde{u}) = 2\chi(\Sigma) - \#\Gamma_1 - 2(\#\Gamma_0)$, then u is immersed and transverse to X_λ .*

An important special case we will encounter in Chapter 5 is the following. Suppose Σ is a sphere with $m \geq 0$ disks removed, so $\chi(\Sigma) = 2 - m$, and there is a trivialization Φ in which each boundary component has Maslov index -2 . Assume also that the punctures

$$\Gamma = \{z_0, z_1, \dots, z_N\}$$

are all positive and odd, with $\mu_{\text{CZ}}^\Phi(P_0) = 3$ for the asymptotic limit P_0 at z_0 , and $\mu_{\text{CZ}}^\Phi(P_j) = -1$ for all the others. Then

$$2 \text{wind}_\pi(\tilde{u}) \leq \mu(\tilde{u}) - 2\chi(\Sigma) + \#\Gamma = 3 - N - 2m - 2(2 - m) + (N + 1) = 0,$$

so any such solution is automatically transverse to X_λ . Notice that this doesn't depend on the number of boundary components. Recalling Example 4.1.2, we can therefore begin with an embedded finite energy surface and, under the right circumstances, guarantee that the surface must remain immersed as we cut out disks and homotop the new solution via the implicit function theorem. We will be able to use the intersection theory of the next section to strengthen this statement by replacing "immersed" with "embedded".

Further corollaries of Theorem 4.3.7 arise from the fact that $\text{wind}_\pi(\tilde{u})$ is always nonnegative. For instance, applying the inequality to a case where the set of punctures Γ is empty, we have:

Corollary 4.3.9. *If $\tilde{u} : \mathbb{D} \rightarrow \mathbb{R} \times M$ is a solution to (BP) with $\pi T\tilde{u}$ not identically zero, then $\mu(\tilde{u}) \geq 2$.*

This will be useful when we look at the bubbling off of holomorphic disks in Chapter 5, and we will also use some more general versions in the proof of the main compactness theorems.

4.4 Intersections

In the study of closed holomorphic curves in four dimensions, one can show that the limit of a compact sequence of embedded curves is always either embedded or multiply covered. This type of result follows immediately from an inequality known as the *adjunction formula* (see [MS04]). At a more basic level, it depends on the fact that isolated intersections of two holomorphic curves (or of a holomorphic curve with itself) always have positive intersection index, thus the number of such intersections can be bounded by topological invariants. The same techniques make it possible to

prove that if two sequences \tilde{u}_k and \tilde{v}_k of non-intersecting holomorphic curves both converge to limits \tilde{u} and \tilde{v} , then the images of these two limits are either identical or disjoint. A result of this type is of course vital to the study of foliations.

Under sufficiently nice conditions, such results hold for curves with punctures and boundary as well. A version of the adjunction formula for compact holomorphic curves with boundary was proved by R. Ye in [Y98]. In the case of Problem **(BP)**, it is not so simple to define a homotopy invariant intersection number due to the variable boundary condition, i.e. we cannot guarantee that intersections don't appear and disappear as the boundary moves through a family of distinct totally real submanifolds. Instead of attempting to develop an algebraic intersection theory, we'll simply adapt some of Ye's local arguments to find criteria for proving that solutions to **(BP)** are embedded and non-intersecting, which suffices for our purposes. The results of the previous section allow us to assume whenever necessary that all solutions are immersed and transverse to the Reeb vector field.

4.4.1 Somewhere injective curves

Some general facts about the behavior of asymptotically cylindrical holomorphic curves near a puncture will be needed. These follow from an asymptotic representation formula for two finite energy half-cylinders with the same asymptotic limit; for details we refer to [Kr98] and the forthcoming thesis by R. Siefring [Sf05].

Proposition 4.4.1. *Let (M, λ) be a contact 3-manifold and denote $\dot{\mathbb{D}} = \mathbb{D} \setminus \{0\}$, $\dot{\mathbb{D}}_r = \mathbb{D}_r \setminus \{0\}$ for $r > 0$.*

- (i) *If $\tilde{u} : \dot{\mathbb{D}} \rightarrow \mathbb{R} \times M$ is an asymptotically cylindrical \tilde{J} -holomorphic curve, then for sufficiently small $\epsilon > 0$ there exists a holomorphic covering map $\varphi : \dot{\mathbb{D}}_\epsilon \rightarrow \dot{\mathbb{D}}_\epsilon$ and a \tilde{J} -holomorphic embedding $\tilde{v} : \dot{\mathbb{D}}_\epsilon \rightarrow \mathbb{R} \times M$ such that*

$$\tilde{u}|_{\dot{\mathbb{D}}_\epsilon} = \tilde{v} \circ \varphi.$$

- (ii) *Suppose $\tilde{u}, \tilde{v} : \dot{\mathbb{D}} \rightarrow \mathbb{R} \times M$ are asymptotically cylindrical \tilde{J} -holomorphic curves with the same asymptotic limit. Then for sufficiently small $\epsilon > 0$, either $\tilde{u}(\dot{\mathbb{D}}_\epsilon)$ and $\tilde{v}(\dot{\mathbb{D}}_\epsilon)$ are disjoint or $\tilde{u}(\dot{\mathbb{D}}_\epsilon) \subset \tilde{v}(\dot{\mathbb{D}})$.*

The images of two asymptotically cylindrical curves are thus embedded and non-intersecting near the punctures; moreover since both maps are proper, these images can be assumed to lie outside any given compact subset of $\mathbb{R} \times M$.

Recall that a \tilde{J} -holomorphic curve $\tilde{u} : \dot{\Sigma} \rightarrow \mathbb{R} \times M$ is called *somewhere injective* if there is a point $z \in \dot{\Sigma}$ such that $d\tilde{u}(z) \neq 0$ and $\tilde{u}^{-1}(\tilde{u}(z)) = \{z\}$. The point z is then called an *injective point* for \tilde{u} .

Proposition 4.4.2. *Let $\tilde{u} : \dot{\Sigma} = \Sigma \setminus \Gamma \rightarrow \mathbb{R} \times M$ be a non-constant solution to Problem (BP). If \tilde{u} is somewhere injective then its set of noninjective points is at most countable and is contained in a compact subset of $\dot{\Sigma}$. Otherwise, there is a compact Riemann surface Σ' with boundary, a finite set of interior punctures $\Gamma' \subset \text{int } \Sigma'$, a holomorphic map $\varphi : \Sigma \rightarrow \Sigma'$ and a somewhere injective solution $\tilde{v} : \dot{\Sigma}' = \Sigma' \setminus \Gamma' \rightarrow \mathbb{R} \times M$ to (BP), such that*

$$\varphi(\Gamma) = \Gamma', \quad \varphi(\dot{\Sigma}) = \dot{\Sigma}', \quad \varphi(\partial\Sigma) = \partial\Sigma',$$

$$\deg(\varphi) \geq 2,$$

and

$$\tilde{u} = \tilde{v} \circ \varphi.$$

Proof. With the aid of Prop. 4.4.1, this follows from roughly the same argument as for closed holomorphic curves (cf. [MS04]). In brief, we can construct such a factorization $\tilde{u} = \tilde{v} \circ \varphi$ for *any* solution $\tilde{u} : \dot{\Sigma} \rightarrow \mathbb{R} \times M$; then it becomes clear from the construction that $\deg(\varphi) = 1$ if \tilde{u} is somewhere injective, and the set of noninjective points is then countable and stays away from the punctures.

Following [MS04], we construct Σ' from the image of \tilde{u} . Let $X' \subset \mathbb{R} \times M$ be the set of critical values of \tilde{u} and let $X = \tilde{u}^{-1}(X')$. Both sets are finite since \tilde{u} has no critical points near the punctures. Then define $Q \subset \tilde{u}(\dot{\Sigma}) \setminus X'$ to be the set of points where two branches meet, i.e. $\tilde{u}(z) \in Q$ if it is a regular value and there's a point $\zeta \neq z$ such that $\tilde{u}(z) = \tilde{u}(\zeta)$ and for all sufficiently small neighborhoods \mathcal{U} and \mathcal{V} of z and ζ respectively, $\tilde{u}(\mathcal{U}) \neq \tilde{u}(\mathcal{V})$. This defines a discrete subset of $\tilde{u}(\dot{\Sigma}) \setminus X'$ since the intersections can only accumulate at critical points; also by Prop. 4.4.1, these intersections stay within a compact subset away from the punctures. Then $S := \tilde{u}(\dot{\Sigma}) \setminus (X' \cup Q)$ is a smooth 2-manifold with boundary, with a natural \tilde{J} -invariant embedding $\iota : S \rightarrow \mathbb{R} \times M$, thus defining a complex structure $j' = \iota^* \tilde{J}$. Topologically, S is a compact surface with finitely many punctures on the boundary and in the interior; these can all be filled in to define a compact Riemann surface (Σ', j') , and there are then natural holomorphic maps $\varphi : \Sigma \rightarrow \Sigma'$ and $\tilde{v} : \Sigma' \rightarrow \mathbb{R} \times M$ such that $\tilde{u} = \tilde{v} \circ \varphi$. The map \tilde{v} is an embedding near the punctures and everywhere in the interior except on a countable set of points. \square

Proving that a solution is somewhere injective is often rather easy if one has some knowledge of its boundary and/or asymptotic behavior.

Corollary 4.4.3. *Suppose $\tilde{u} : \dot{\Sigma} \rightarrow \mathbb{R} \times M$ is a solution to (BP), having an asymptotic limit $P \subset M$ that is simply covered and is the limit at only one puncture. Then \tilde{u} is somewhere injective.*

4.4.2 Excluding intersections in M

Let (M, λ) be a compact 3-dimensional contact manifold with boundary $L = \partial M$, where L is a finite union of tori $L_1 \cup \dots \cup L_m$ tangent to X_λ . We define the boundary conditions for Problem **(BP)** by smooth families of graphs $\tilde{L}_j^\sigma \subset \mathbb{R} \times M$ covering the tori $L_j \subset M$.

As was mentioned earlier, it is not immediately clear how to count isolated intersections for maps $\dot{\Sigma} \rightarrow \mathbb{R} \times M$ that satisfy a variable boundary condition. One can see this from the following example: let $\tilde{L}^\sigma = \mathbb{R} \times (\mathbb{R} + i\sigma) \subset \mathbb{C}^2$ and consider the intersections of maps $\mathbb{D}^+ \rightarrow \mathbb{C}^2$ defined by $u(z) = (z, 0)$ and the smooth family $v_\tau(z) = (z, z + i\tau)$, satisfying $u(\mathbb{D}^+ \cap \mathbb{R}) \subset \tilde{L}^0$ and $v_\tau(\mathbb{D}^+ \cap \mathbb{R}) \subset \tilde{L}^\tau$. These intersect if and only if $\tau \leq 0$. One could attempt to fix the problem by counting intersections only for maps that satisfy exactly the same boundary condition—but this is of limited use if there is more than one boundary component, since we cannot assume the boundary conditions at different components will move in any coordinated manner under homotopies.

Much can still be said if we only want to exclude intersections of the projected maps $\dot{\Sigma} \rightarrow M$; this works especially nicely in the \mathbb{R} -invariant case. For Problem **(BP₀)**, we assume each family \tilde{L}_j^σ consists of \mathbb{R} -translations of a single graph \tilde{L}_j .

Theorem 4.4.4. *Let $\tilde{u}_k = (a_k, u_k) : \dot{\Sigma} \rightarrow \mathbb{R} \times M$ be a sequence of solutions to **(BP₀)** such that $u_k : \dot{\Sigma} \rightarrow M$ is injective for all k , and assume $\tilde{u}_k \rightarrow \tilde{u}$ in $C_{\text{loc}}^\infty(\dot{\Sigma}, \mathbb{R} \times M)$, where $\tilde{u} = (a, u) : \dot{\Sigma} \rightarrow \mathbb{R} \times M$ is a solution to **(BP₀)** that is immersed, somewhere injective and transverse to $\mathbb{R} \times \partial M$. Then either $u : \dot{\Sigma} \rightarrow M$ is injective or its image is contained in some periodic orbit $P \subset M$.*

Note that the limit \tilde{u} is necessarily embedded as a consequence. The next result concerns intersections of two sequences of solutions to **(BP₀)**.

Theorem 4.4.5. *Let $\tilde{u}_k = (a_k, u_k) : \dot{\Sigma}_1 \rightarrow \mathbb{R} \times M$ and $\tilde{v}_k = (b_k, v_k) : \dot{\Sigma}_2 \rightarrow \mathbb{R} \times M$ be sequences of solutions to **(BP₀)** such that $u_k(\dot{\Sigma}_1) \cap v_k(\dot{\Sigma}_2) = \emptyset$ for all k . Assume both sequences converge in C_{loc}^∞ to solutions $\tilde{u} = (a, u) : \dot{\Sigma}_1 \rightarrow \mathbb{R} \times M$ and $\tilde{v} = (b, v) : \dot{\Sigma}_2 \rightarrow \mathbb{R} \times M$ that are immersed and transverse to $\mathbb{R} \times \partial M$. Then $u(\dot{\Sigma}_1)$ and $v(\dot{\Sigma}_2)$ are either disjoint or identical.*

For both theorems, we need not assume the almost complex structure on $\mathbb{R} \times M$ is fixed; the sequences may be \tilde{J}_k -holomorphic with respect to a C^∞ -compact family of almost complex structures, $\tilde{J}_k \rightarrow \tilde{J}$.

Remark 4.4.6. *The setup in which M has nonempty boundary is convenient for stating these results, but not essential. As we'll see below, what matters is that the*

totally real surfaces \tilde{L}_j^σ are contained in an oriented hypersurface $H \subset \mathbb{R} \times M$ (in this case $\mathbb{R} \times \partial M$) such that our solutions always meet H transversely and approach it “from the same side”. The transversality condition is guaranteed whenever wind_π vanishes, since X_λ is tangent to the hypersurface.

The proofs of these results rest on defining the proper notion of a local intersection index for boundary intersections. This is somewhat tricky: in general, even if two maps of a surface with boundary into a 4-manifold have only positive interior intersections, there is nothing to stop these intersections from “escaping off the boundary” under homotopies. The situation is better if a totally real boundary condition is imposed. One expects greater control in this case, since the boundaries themselves are now confined to a submanifold in which they have complementary dimension. Even so, the following example demonstrates why this is not quite enough.

Example 4.4.7. Define a pair of holomorphic half-disks $u_j : (\mathbb{D}^+, i) \rightarrow (\mathbb{C}^2, i)$ by $u_1(z) = (z, 0)$ and $u_2(z) = (-z, z^2)$. These are both embeddings, satisfy the totally real boundary condition $u_j(\mathbb{D}^+ \cap \mathbb{R}) \subset \mathbb{R}^2$, and have a single isolated intersection at $(0, 0)$. However, one can perturb u_2 to $u_2^\epsilon(z) = (-z, z^2 + \epsilon)$, which never intersects u_1 if $\epsilon > 0$.

Following [Y98], we shall introduce an additional assumption in order to exclude the situation of Example 4.4.7. In the following, W is 4-dimensional manifold, with $N \subset W$ a 2-dimensional submanifold.

Definition 4.4.8. Let $f_j : \mathbb{D}^+ \rightarrow W$, $j \in \{1, 2\}$, be smooth embeddings with $f_j(\mathbb{D}^+ \cap \mathbb{R}) \subset N$ and an intersection $f_1(0) = f_2(0) = p$. We say that f_1 and f_2 have a one-sided intersection at p if there exists an oriented hypersurface $H \subset W$ containing N , such that

- (i) f_1 and f_2 are both transverse to H at 0,
- (ii) For any sequence $z_k \in \mathbb{D}^+ \setminus (\mathbb{D}^+ \cap \mathbb{R})$ approaching 0, $f_1(z_k)$ and $f_2(z_k)$ approach H from the same side. In other words, we can identify a tubular neighborhood of $H \subset W$ with $\mathbb{R} \times H$ and find that for sufficiently large k , $f_j(z_k) \in \mathbb{R} \times H$ all have a fixed sign in the \mathbb{R} -factor.

Note that by condition (i), we can assume without loss of generality (using the implicit function theorem) that $f_j^{-1}(N) \subset \mathbb{D}^+ \cap \mathbb{R}$. Then to prove an intersection is one-sided, one only has to take coordinates $z = s + it$ on \mathbb{D}^+ and show that $\partial_t f_1(0)$ and $\partial_t f_2(0)$ have the same sign when projected to the normal bundle of H , as defined by the orientation. The assumption that H has an orientation is harmless since the question is purely local.

Definition 4.4.9. Let $f_1 : \mathbb{D}^+ \rightarrow W$ and $f_2 : \mathbb{D}^+ \rightarrow W$ be two embeddings with an isolated intersection $f_1(0) = f_2(0) = p$. We call this intersection *simple* if the subspaces $\text{im } df_1(x)$ and $\text{im } df_2(y)$ of $T_p W$ are either transverse or identical.

Notice that in particular for pseudoholomorphic curves, all intersections are simple, and *any* map can be perturbed so that intersections are transverse (and therefore simple).

It turns out that one can sensibly define a local intersection index for isolated, one-sided simple intersections. Suppose $f_1 : \mathbb{D}^+ \rightarrow W$ and $f_2 : \mathbb{D}^+ \rightarrow W$ are embeddings that have such an intersection at $f_1(0) = f_2(0) = p$, and both satisfy the boundary condition $f_j(\mathbb{D}^+ \cap \mathbb{R}) \subset N$. If the two maps are transverse at 0, we define the intersection index to be ± 1 , the same as with an interior intersection. If they are not transverse, then by assumption they must be tangent, and we can treat them as follows. The one-sided assumption guarantees that $\text{im } df_1(0) \not\subset T_p N$, so we may choose coordinates near p , identifying p with $0 \in \mathbb{C}^2$, such that $f_1(z) = (z, 0)$ and $N = \mathbb{R}^2 \subset \mathbb{C}^2$. (We're using complex-valued coordinates for notational convenience, but one could just as well say \mathbb{R}^4 instead of \mathbb{C}^2 .) Denote $f_2 = (\varphi, \psi) : \mathbb{D}^+ \rightarrow \mathbb{C}^2$; then we have $\varphi(\mathbb{D}^+ \cap \mathbb{R}) \subset \mathbb{R}$ and $\psi(\mathbb{D}^+ \cap \mathbb{R}) \subset \mathbb{R}$. Since f_1 and f_2 are both embedded and tangent at 0, it follows that $d\psi(0) = 0$, so $d\varphi(0)$ must be an isomorphism. Without loss of generality, we may assume $\partial_s \varphi(0) > 0$: then the crucial consequence of the one-sided assumption is that $\partial_t \varphi(0)$ lies in the upper half-plane. Thus by the implicit function theorem, φ is a diffeomorphism of some neighborhood of 0 in \mathbb{D}^+ to another such neighborhood, preserving the positive/negative real axes. We can now reparametrize f_2 on a neighborhood of 0 in \mathbb{D}^+ and change ψ accordingly so that $f_2(z) = (z, \psi(z))$. This new map ψ still satisfies $\psi(s) \in \mathbb{R}$ for $s \in \mathbb{R}$. Referring to Sec. 4.3, we define the *local intersection index*

$$(f_1, 0) \bullet (f_2, 0)$$

to be the order of the zero of ψ at 0. Recall that this means extending ψ over a neighborhood of 0 in \mathbb{D} by $\psi(\bar{z}) = \overline{\psi(z)}$, and then counting the winding of this extended map over a small circle around 0.

For interior intersections $f_1(z_1) = f_2(z_2)$, the local intersection index $(f_1, z_1) \bullet (f_2, z_2)$ is defined in the standard way—we will always assume that an intersection is either in the interior for both maps or on the boundary for both maps.

Lemma 4.4.10. Let W be a 4-manifold containing a surface $N \subset W$. Suppose $f_1 : \mathbb{D}^+ \rightarrow W$ and $f_2 : \mathbb{D}^+ \rightarrow W$ are embeddings satisfying $f_j(\mathbb{D}^+ \cap \mathbb{R}) \subset N$, and they have disjoint images except for a one-sided simple intersection $f_1(0) = f_2(0) = p$. Let f_1^ϵ and f_2^ϵ be C^1 -close perturbations of f_1 and f_2 , both satisfying $f_j^\epsilon(\mathbb{D}^+ \cap \mathbb{R}) \subset N$. Assume f_1^ϵ and f_2^ϵ have a finite number of intersections, and all

boundary intersections are simple. Then there is a neighborhood $0 \in \mathcal{U}^+ \subset \mathbb{D}^+$ such that if f_j^ϵ are sufficiently C^1 -close to f_j for $j \in \{1, 2\}$ then $(f_1, 0) \bullet (f_2, 0)$ is equal to

$$2 \sum_{\substack{f_1^\epsilon(z_1)=f_2^\epsilon(z_2) \\ z_2 \in \mathcal{U}^+ \setminus (\mathcal{U}^+ \cap \mathbb{R})}} (f_1^\epsilon, z_1) \bullet (f_2^\epsilon, z_2) + \sum_{\substack{f_1^\epsilon(z_1)=f_2^\epsilon(z_2) \\ z_2 \in \mathcal{U}^+ \cap \mathbb{R}}} (f_1^\epsilon, z_1) \bullet (f_2^\epsilon, z_2).$$

Proof. The one-sided assumption implies $\text{im } df_1(0) \not\subset T_p N$, so as in the above discussion of the local intersection index, we can choose coordinates near p so that $f_1(z) = (z, 0) \in \mathbb{C}^2$ and $N = \mathbb{R}^2$. Since f_1^ϵ is C^1 -close to f_1 , we can choose a second coordinate chart, C^1 -close to the first one, in which $f_1^\epsilon(z) = (z, 0)$ and $N = \mathbb{R}^2$. The map f_2^ϵ , expressed in the second chart, is C^1 -close to f_2 , as expressed in the first chart. Thus we are free to assume that $N = \mathbb{R}^2$ and $f_1^\epsilon(z) = f_1(z) = (z, 0)$. Write $f_2(z) = (\varphi(z), \psi(z))$ and $f_2^\epsilon(z) = (\varphi^\epsilon(z), \psi^\epsilon(z))$: the boundary condition implies that each of these four functions is real-valued on $\mathbb{D}^+ \cap \mathbb{R}$.

If f_1 and f_2 are transverse, then the restricted maps $f_j : \mathbb{D}^+ \cap \mathbb{R} \rightarrow N$ are also transverse, so the perturbation f_2^ϵ will also have a single transverse intersection with f_1 on the boundary, with the same sign, and none in the interior.

Otherwise, f_1 and f_2 are tangent at 0, which means $d\psi(0) = 0$ and $d\varphi(0)$ is an isomorphism, so we can reparametrize for convenience and write $f_2(z) = (z, \psi(z))$. (The reparametrization identifies the new domain \mathbb{D}^+ with some neighborhood of 0 in the original domain; we choose \mathcal{U}^+ to be this neighborhood.) Since $\psi(\mathbb{D}^+ \cap \mathbb{R}) \subset \mathbb{R}$, we can extend ψ continuously over \mathbb{D} by $\psi(\bar{z}) = \overline{\psi(z)}$, and $(f_1, 0) \bullet (f_2, 0) = \text{wind}_{\partial\mathbb{D}}(\psi)$. If f_2^ϵ is C^1 -close to f_2 , we can reparametrize it in the same manner and write $f_2^\epsilon(z) = (z, \psi^\epsilon(z))$, with ψ^ϵ C^1 -close to ψ . Extending ψ^ϵ over \mathbb{D} , we have a continuous map that is C^0 -close to ψ , thus $\text{wind}_{\partial\mathbb{D}}(\psi^\epsilon) = \text{wind}_{\partial\mathbb{D}}(\psi)$. But this is precisely the algebraic count of zeros for ψ^ϵ inside \mathbb{D} , or equivalently, the sum of boundary intersection indices plus twice the sum of interior intersection indices. \square

Remark 4.4.11. *The same argument proves a similar property for simple intersections in the interior.*

One can see from Lemma 4.4.10 that any notion of a homotopy invariant intersection number for holomorphic curves with boundary must weight interior intersections twice as heavily as boundary intersections. This feature is apparent, e.g. in Ye's adjunction formula [Y98]. For our purposes, it suffices to know that *positive* intersections cannot be destroyed by small perturbations.

Proposition 4.4.12 (Positivity of intersections). *Let (W, J) be an almost complex 4-manifold, containing a totally real submanifold $N \subset W$.*

- (i) *Suppose $u, v : \mathbb{D} \rightarrow W$ are J -holomorphic embeddings with an isolated intersection $u(0) = v(0)$. Then $(u, 0) \bullet (v, 0) > 0$.*

(ii) Suppose $u, v : \mathbb{D}^+ \rightarrow W$ are J -holomorphic embeddings with $u(\mathbb{D}^+ \cap \mathbb{R}) \subset N \supset v(\mathbb{D}^+ \cap \mathbb{R})$ and an isolated one-sided intersection $u(0) = v(0) \in N$. Then $(u, 0) \bullet (v, 0) > 0$.

Proof. We focus on the second statement, which follows from the boundary version of the similarity principle (Prop. 4.3.4). We can choose coordinates and treat u and v as \bar{J} -holomorphic maps into \mathbb{C}^2 for some almost complex structure \bar{J} , with $u(0) = v(0) = 0$, $N = \mathbb{R}^2$, $u(z) = (z, 0)$ and $\bar{J}(z, 0) = i$. Then writing $v(z) = (\varphi(z), \psi(z))$, it follows from standard arguments (cf. [MS04]) that $\psi : \mathbb{D}^+ \rightarrow \mathbb{C}$ satisfies a PDE of the form

$$\psi_s(s, t) + i\psi_t(s, t) = A(s, t)\psi(s, t)$$

for a smooth family of real-linear maps $A(s, t) : \mathbb{C} \rightarrow \mathbb{C}$. We have also $\psi(0, 0) = 0$ and $\psi(s, 0) \in \mathbb{R}$, thus by the similarity principle, there is a smooth map $\Phi : \mathbb{D}^+ \rightarrow \mathbb{C} \setminus \{0\}$ with $\Phi(0, 0) = 1$, $\Phi(s, 0) \in \mathbb{R} \setminus \{0\}$, and a map $f : \mathbb{D}^+ \rightarrow \mathbb{C}$ with $f(0, 0) = 0$, $f(s, 0) \in \mathbb{R}$, such that

$$\psi(z) = \Phi(z)f(z)$$

and f is holomorphic on some neighborhood of 0. Extending over \mathbb{D} by the reflection principle, f winds positively around 0, and Φ doesn't wind at all since it has no zeros in the disk. Thus ψ has the same winding number as f .

The version for interior intersections is proved in the same way. \square

Proof of Theorem 4.4.4. Suppose $u(z_1) = u(z_2)$ for $z_1 \neq z_2$. Then writing $\tilde{u}^\sigma = (a + \sigma, u)$ for $\sigma \in \mathbb{R}$, there is an intersection $\tilde{u}^\sigma(z_1) = \tilde{u}^\sigma(z_2)$ for some $\sigma \in \mathbb{R}$. By assumption, \tilde{u} (and hence \tilde{u}^σ) is somewhere injective and immersed, so the intersection is isolated unless $\tilde{u}^\sigma(\dot{\Sigma}) = \tilde{u}(\dot{\Sigma})$ and $\sigma \neq 0$. In this case, for any $z \in \dot{\Sigma}$ and $N \in \mathbb{N}$ we can find $z_N \in \dot{\Sigma}$ such that $\tilde{u}(z_N) = \tilde{u}^{N\sigma}(z)$. The right hand side escapes from any compact set as $N \rightarrow \pm\infty$, thus we deduce that $\dot{\Sigma}$ has at least one positive and one negative puncture, with subsequences of z_N approaching each as $N \rightarrow \pm\infty$. Denote the asymptotic orbits at these punctures by $P_\pm \subset M$; then $u(z) = u(z_N) \rightarrow P_\pm$, so both are the same orbit, and it contains the image of u .

Assume now that the intersection $\tilde{u}^\sigma(z_1) = \tilde{u}^\sigma(z_2)$ is isolated. Both z_1 and z_2 are either in the interior or on the boundary; in the former case it follows from positivity of intersections and Remark 4.4.11 that there are points ζ_1 near z_1 and ζ_2 near z_2 such that $\tilde{u}_k^\sigma(\zeta_1) = \tilde{u}_k(\zeta_2)$ for large k . To handle boundary intersections, denote by γ_1 and γ_2 the connected components of $\partial\Sigma$ containing z_1 and z_2 respectively. Using the \mathbb{R} -invariance of the boundary condition, we can choose sequences $\sigma_k \rightarrow \sigma$ and $\tau_k \rightarrow 0$ such that $\tilde{u}_k^{\sigma_k}(\gamma_1)$ and $\tilde{u}_k^{\tau_k}(\gamma_2)$ lie in the same totally real submanifold as $\tilde{u}^\sigma(\gamma_1)$ and $\tilde{u}(\gamma_2)$. Then using positivity of intersections and Lemma 4.4.10, there are points ζ_1 near z_1 and ζ_2 near z_2 such that $\tilde{u}_k^{\sigma_k}(\zeta_1) = \tilde{u}_k^{\tau_k}(\zeta_2)$ for large k . Hence $u_k(\zeta_1) = u_k(\zeta_2)$, a contradiction. \square

Proof of Theorem 4.4.5. Suppose u and v do not have identical images and there's an intersection $u(z_1) = v(z_2)$. Then, writing $\tilde{u}^\sigma = (a + \sigma, u)$ for $\sigma \in \mathbb{R}$, there is an isolated intersection $\tilde{u}^\sigma(z_1) = \tilde{v}(z_2)$ for some $\sigma \in \mathbb{R}$. Repeating the argument used to prove Theorem 4.4.4, one finds that $\tilde{u}_k^{\sigma_k}$ and $\tilde{v}_k^{\tau_k}$ intersect at points near z_1 and z_2 for some sequences $\sigma_k \rightarrow \sigma$ and $\tau_k \rightarrow 0$. \square

Occasionally, one would like a version of Theorem 4.4.4 for the non- \mathbb{R} -invariant problem as well. In this case, something extra is needed to rule out self-intersections at the boundary, but this may not be so hard if $u \pitchfork X_\lambda$ and the Reeb flow along L is fairly simple. Given such an assumption, the same argument as before rules out interior self-intersections, and we have:

Proposition 4.4.13. *Let $\tilde{u}_k = (a_k, u_k) : \dot{\Sigma} \rightarrow \mathbb{R} \times M$ be a sequence of solutions to **(BP)** such that $u_k : \dot{\Sigma} \rightarrow M$ is injective for all k , and assume $\tilde{u}_k \rightarrow \tilde{u}$ in $C_{\text{loc}}^\infty(\dot{\Sigma}, \mathbb{R} \times M)$, where $\tilde{u} = (a, u) : \dot{\Sigma} \rightarrow \mathbb{R} \times M$ is a solution to **(BP)** that is immersed, somewhere injective and transverse to $\mathbb{R} \times \partial M$. Assume also that $u|_{\partial \Sigma} : \partial \Sigma \rightarrow \mathbb{R} \times M$ is injective. Then either $u : \dot{\Sigma} \rightarrow M$ is injective or its image is contained in some periodic orbit $P \subset M$.*

It is routine to extend these arguments to noncompact sequences \tilde{u}_k and \tilde{v}_k that degenerate to finite energy surfaces without boundary as $k \rightarrow \infty$. We'll have more to say about this in Chapter 5.

4.5 Fredholm theory

In this section we investigate the space of solutions to **(BP)** near a given solution. There is a standard recipe for attacking such questions: first one defines suitable Banach spaces (or manifolds, bundles etc.) X and Y so that the solution space can be described as the zero set of a smooth nonlinear map $F : X \rightarrow Y$. If there is a solution $\tilde{u} \in F^{-1}(0) \subset X$ for which the linearization $dF(\tilde{u}) : X \rightarrow Y$ is a surjective Fredholm operator, then the infinite dimensional version of the implicit function theorem (see [La93]) implies that the set of solutions near \tilde{u} has the structure of a smooth finite dimensional manifold. Carrying this type of argument one step further, one can set up a parametrized family of problems $F_\tau : X \rightarrow Y$, and use the above result to prove that the solution set varies smoothly with small perturbations of τ .

There are several steps in carrying out this program. We begin by defining in Sec. 4.5.1 a generalized version of Problem **(BP)** for almost complex 4-manifolds with cylindrical ends, and then finding suitable coordinates to describe the neighborhood of any embedded solution. The functional analytic setup is presented in

Sec. 4.5.2, where we define a Banach space bundle with a smooth section whose zero set contains the solutions of interest. This generalizes the setup in [HWZ99] to the situation where Σ may have boundary, and punctures may have Morse-Bott asymptotic limits. The Banach space bundle is defined using Hölder spaces, which are more convenient than Sobolev spaces for the nonlinear problem. In Sec. 4.5.3 we write down the linearized operator as a map between Hölder spaces with exponential weights, then relate this to an operator on Sobolev spaces and prove the Fredholm property. The analysis depends heavily on the results for similar problems studied by Hofer, Wysocki and Zehnder [HWZ99], and Schwarz [Sch96]. A formula for the Fredholm index is presented in Sec. 4.5.4, using a simple doubling argument to reduce the problem to M. Schwarz’s formalism for Cauchy-Riemann operators on Riemann surfaces with cylindrical ends [Sch96]. It remains to prove that the linearization is surjective before the implicit function theorem can be applied. With elliptic problems of this sort, one typically must assume generic conditions (e.g. a generic almost complex structure) before any conclusion about transversality is possible. However, it is a convenient feature of the four-dimensional setting that transversality sometimes holds without any genericity assumption. Some results of this type are proved in Sec. 4.5.5, generalizing a theorem of Hofer, Lizan and Sikorav [HLS97], as well as a similar folk theorem for finite energy surfaces; we refer to these here as “automatic” transversality results. Finally, Sec. 4.5.6 applies the implicit function theorem to gain a local understanding of the moduli space of solutions, and Sec. 4.5.7 extends the discussion to problems that depend smoothly on a parameter, so that we may vary \tilde{J} and \tilde{u} simultaneously.

The eventual goal is to apply these results to a situation in which we start with some almost complex structure \tilde{J}_0 and a family of \tilde{J}_0 -holomorphic curves $\{\tilde{u}_\sigma\}$, then homotop this family along with a homotopy of \tilde{J}_0 to another complex structure \tilde{J}_1 . This perturbation of \tilde{J} will not be small, so continuing the homotopy of $\{\tilde{u}_\sigma\}$ beyond a small neighborhood will require some compactness arguments, to be presented in Chapter 5. It should be noted that the automatic transversality results are also crucial for this, as we cannot assume that a homotopy from \tilde{J}_0 to \tilde{J}_1 passes only through generic almost complex structures.

4.5.1 Problem (BP′) and special coordinates

The moduli space $\mathcal{M}(\hat{J}, L)$

For the Fredholm theory discussion, we consider a generalization of Problem (BP), defined as follows. Let (W, \hat{J}) be an almost complex 4-manifold with cylindrical ends, as in [BEHWZ03]. Specifically, this means that W can be decomposed as $W = E_- \cup W_0 \cup E_+$, where $E_+ = [0, \infty) \times M_+$ and $E_- = (-\infty, 0] \times M_-$ for some closed

contact 3-manifolds (M_{\pm}, λ_{\pm}) , and (W_0, J_0) is a compact almost complex 4-manifold with boundary, glued to E_{\pm} via some diffeomorphism of ∂W to $M_+ \sqcup M_-$. We require that the almost complex structure \hat{J} match J_0 on W_0 and \tilde{J}_{\pm} on E_{\pm} , where \tilde{J}_{\pm} is defined by λ_{\pm} and some admissible complex multiplication J_{\pm} on $\xi_{\pm} = \ker \lambda_{\pm}$.

We will now deal with maps $\tilde{u} : \dot{\Sigma} \rightarrow W$ where $\dot{\Sigma} = \Sigma \setminus \Gamma$ is a compact oriented surface with punctures $\Gamma \subset \text{int } \Sigma$ and boundary components $\partial \Sigma = \gamma_1 \cup \dots \cup \gamma_m$. To set up the boundary condition, we choose for each component $\gamma_j \subset \partial \Sigma$ a 2-manifold Λ_j and an embedding $\iota_j : (-1, 1) \times \Lambda_j \hookrightarrow W$ such that for each $\tau \in (-1, 1)$, the surface $L_{\tau} := \iota_j(\{\tau\} \times \Lambda_j)$ is a totally real submanifold of (W, \hat{J}) . Thus the image of ι_j is a hypersurface $H_j \subset W$, which has a smooth foliation \mathcal{F}_j by totally real submanifolds $L_{\tau} \subset H_j \subset W$, all of which are diffeomorphic. Define $\tilde{u} : \dot{\Sigma} \rightarrow W$ to be a solution of Problem **(BP')** if

- (i) \tilde{u} is \hat{J} -holomorphic with respect to some complex structure j on $\dot{\Sigma}$.
- (ii) \tilde{u} is a proper map, and is asymptotically cylindrical at the punctures. This means every puncture is marked either *positive* or *negative*, and \tilde{u} maps the neighborhood of each positive/negative puncture into $E_{\pm} \subset \mathbb{R} \times M_{\pm}$, with asymptotic convergence to a (nondegenerate or Morse-Bott) periodic orbit as in Definition 1.1.9.
- (iii) for each component $\gamma_j \subset \partial \Sigma$, $j = 1, \dots, m$, we have the boundary condition $\tilde{u}(\gamma_j) \subset L$ for some $L \in \mathcal{F}_j$.
- (iv) \tilde{u} is an embedding, with the restriction to some neighborhood of $\gamma_j \subset \partial \Sigma$ transverse to H_j .

The last condition is purely technical in nature: it facilitates the particular approach to the Fredholm theory that we wish to take, using the normal bundle. Observe that by condition (ii), \tilde{u} can always be written in some neighborhood \mathcal{U} of a positive/negative puncture as $\tilde{u} = (a, u) : \mathcal{U} \rightarrow \mathbb{R} \times M_{\pm}$.

Remark 4.5.1. *We're now requiring j to be defined only on $\dot{\Sigma}$, not necessarily extendable over the punctures. This relaxation of previous assumptions will offer some convenience, but is actually not a meaningful change: the asymptotically cylindrical behavior of \tilde{u} implies that it can always be reparametrized near the punctures so that j extends over Σ (cf. Prop. A.3.1).*

Remark 4.5.2. *One could of course pick a single totally real submanifold $L \subset W$ and use the more straightforward boundary condition $\tilde{u}(\partial \Sigma) \subset L$. This problem is Fredholm, but it's index would be too low for the application we have in mind, and transversality would fail.*

The cylindrical ends of W admit a natural compactification

$$\overline{W} = ([-\infty, 0] \times M_-) \cup W_0 \cup ([0, \infty] \times M_+).$$

This is a compact topological manifold with boundary, with natural smooth structures on $\text{int } \overline{W} = W$ and $\partial \overline{W} = (\{-\infty\} \times M_-) \cup (\{\infty\} \times M_+)$. The almost complex structure \hat{J} is defined only in the interior, but λ_{\pm} and ξ_{\pm} extend smoothly to the boundary. By Remark 4.5.1, a solution $\tilde{u} : (\dot{\Sigma}, j) \rightarrow (W, \hat{J})$ of Problem **(BP')** can always be reparametrized so that j is a smooth complex structure on Σ ; for any such parametrization, there is a continuous extension

$$\bar{u} : \overline{\Sigma} \rightarrow \overline{W},$$

mapping each of the circles $\delta_z \subset \partial \overline{\Sigma}$ to $\{\pm\infty\} \times P$ for some periodic orbit $P \subset M_{\pm}$. The restriction $\bar{u}|_{\overline{\Sigma} \setminus \dot{\Sigma}} : \overline{\Sigma} \setminus \dot{\Sigma} \rightarrow \{\pm\infty\} \times M_{\pm}$ is a smooth immersion.

Two solutions $\tilde{u} : \dot{\Sigma}_1 \rightarrow W$ and $\tilde{v} : \dot{\Sigma}_2 \rightarrow W$ are *equivalent* if there is a diffeomorphism $\varphi : \dot{\Sigma}_2 \rightarrow \dot{\Sigma}_1$ such that $\tilde{v} = \tilde{u} \circ \varphi$. Note that if \tilde{u} and \tilde{v} are parametrized so that the complex structures $j_1 = \tilde{u}^* \hat{J}$ and $j_2 = \tilde{v}^* \hat{J}$ extend over the punctures, then Riemann's removable singularity theorem extends φ to a biholomorphic map $(\Sigma_2, j_2) \rightarrow (\Sigma_1, j_1)$.

Denote the moduli space of solutions to Problem **(BP')** up to equivalence by $\mathcal{M}(\hat{J}, L)$, where L represents the collection of data (hypersurfaces H_j and foliations \mathcal{F}_j) that define the boundary condition. We shall often abuse notation and refer to a solution $\tilde{u} : \dot{\Sigma} \rightarrow W$ as an element of $\mathcal{M}(\hat{J}, L)$, when we really mean the equivalence class $[\tilde{u}]$. A topology on $\mathcal{M}(\hat{J}, L)$ is defined by the following notion of convergence.

Definition 4.5.3. *A sequence $\tilde{u}_k : \dot{\Sigma}_k \rightarrow W$ converges in $\mathcal{M}(\hat{J}, L)$ to $\tilde{u} : \dot{\Sigma} \rightarrow W$ if there are diffeomorphisms $\varphi_k : \dot{\Sigma} \rightarrow \dot{\Sigma}_k$ and $\varphi : \dot{\Sigma} \rightarrow \dot{\Sigma}$ such that*

1. $\tilde{u}_k \circ \varphi_k \rightarrow \tilde{u} \circ \varphi$ in $C_{\text{loc}}^{\infty}(\dot{\Sigma}, W)$,
2. $\tilde{u}_k \circ \varphi_k$ and $\tilde{u} \circ \varphi$ each have continuous extensions $\bar{u}_k, \bar{u} : \overline{\Sigma} \rightarrow \overline{W}$ such that $\bar{u}_k \rightarrow \bar{u}$ in $C^0(\overline{\Sigma}, \overline{W})$.

The second condition implies that the asymptotic limits of \tilde{u}_k converge to those of \tilde{u} at the corresponding punctures. If all limits of \tilde{u} are nondegenerate, this means \tilde{u}_k has the same limits for sufficiently large k . We'll prove in Sec. 4.6.4 that in this case, C_{loc}^{∞} -convergence implies convergence in $\mathcal{M}(\hat{J}, L)$.

Trivializing the normal bundle

Following [HWZ99], we shall identify the solutions in some neighborhood of a given solution $\tilde{u}_0 : \dot{\Sigma} \rightarrow W$ with sections of the complex normal bundle $\nu\tilde{u}_0 \rightarrow \dot{\Sigma}$. We assume that at least one of $\partial\Sigma$ and Γ is nonempty, so the normal bundle is trivial, and we'll be able to define the nonlinear Cauchy-Riemann operator on a domain consisting of functions $\dot{\Sigma} \rightarrow \mathbb{C}$. An alternative to the normal bundle approach would be to set up the nonlinear operator on a Banach manifold consisting of maps $\dot{\Sigma} \rightarrow W$; this works also when \tilde{u}_0 is not immersed, and is the approach taken for finite energy surfaces by D. Dragnev in [Dr04]. In that case one must also explicitly consider variations in j through Teichmüller space, whereas here we will avoid this complication by looking for all nearby *complex curves* in W , rather than specifically j - \hat{J} -holomorphic maps. Another advantage of the normal bundle approach is that the linearized operator acts on sections of a complex *line bundle* (the alternative would be a rank 2 complex vector bundle): thus generic sections of this bundle have isolated zeros which can be counted and related to the same topological invariants that appear in the Fredholm index formula. This is what makes possible the automatic transversality results of Sec. 4.5.5.

Let $\tilde{u}_0 : (\dot{\Sigma}, j) \rightarrow (W, \hat{J})$ be a solution of **(BP')**, parametrized so that j extends over the punctures, and denote by \bar{u}_0 the continuous extension $\bar{\Sigma} \rightarrow \bar{W}$. Recall from Sec. 4.2 that there are holomorphic coordinate maps

$$\varphi_z : \dot{\mathcal{U}}_z \rightarrow Z^\pm$$

for a neighborhood $\mathcal{U}_z \subset \Sigma$ of each puncture $z \in \Gamma^\pm$, where $\dot{\mathcal{U}}_z = \mathcal{U}_z \setminus \{z\}$, $Z^+ = [0, \infty) \times S^1$ and $Z^- = (-\infty, 0] \times S^1$. These are referred to below as “cylindrical coordinates”.

The following is a slight generalization of Theorem 4.7 from [HWZ99].

Proposition 4.5.4. *There exists a continuous map $\Psi : \bar{\Sigma} \times B_\epsilon^2(0) \rightarrow \bar{W}$, where $B_\epsilon^2(0) \subset \mathbb{C}$ is a small ball around 0, satisfying $\Psi(z, 0) = \bar{u}_0(z)$ and the following additional properties:*

1. *The restrictions of Ψ to $\dot{\Sigma} \times B_\epsilon^2(0)$ and $(\bar{\Sigma} \setminus \dot{\Sigma}) \times B_\epsilon^2(0)$ are both smooth immersions. Moreover, the restriction to some neighborhood of $\dot{\Sigma} \times \{0\}$ in $\dot{\Sigma} \times B_\epsilon^2(0)$ is an embedding, as is the restriction to $(\Sigma \setminus \mathcal{V}) \times B_\epsilon^2(0)$ for some small neighborhood $\Gamma \subset \mathcal{V} \subset \Sigma$. For $z \in \bar{\Sigma} \setminus \dot{\Sigma}$, the derivative $d\Psi(z, 0)$ maps $T_{(z,0)}(\{z\} \times B_\epsilon^2(0)) = \mathbb{R}^2$ isomorphically to the contact structure $(\xi_\pm)_{\bar{u}_0(z)}$.*
2. *The induced almost complex structure $\bar{J} = \Psi^* \hat{J}$ on $\dot{\Sigma} \times B_\epsilon^2(0)$ takes the form $\bar{J}(z, 0) = j(z) \oplus i$ along $\dot{\Sigma} \times \{0\}$, and in the cylindrical coordinates $(s, t) \in Z^\pm$*

near each puncture $z \in \Gamma^\pm$, $\bar{J}(s, t, v)$ converges in $C^\infty(S^1)$ as $s \rightarrow \pm\infty$ to a smooth 4-by-4 matrix valued function $\bar{J}(\pm\infty, t, v)$ on $S^1 \times B_\epsilon^2(0)$.

3. Suppose \tilde{u}_0 is asymptotic to a Morse-Bott orbit $P_0 \subset M$ at $z \in \Gamma^\pm$, and denote nearby orbits in the Morse-Bott manifold by P_τ for $\tau \in (-1, 1)$. Then working in cylindrical coordinates $(s, t) \in Z^\pm$ near z , there is a nonzero function $\theta : S^1 \rightarrow \mathbb{C}$ such that for each $\tau \in (-1, 1)$,

$$(\pm\infty, x_\tau(t)) := \Psi(\pm\infty, t, \tau\theta(t))$$

gives a smooth parametrization of P_τ with $\lambda(\dot{x}_\tau(t)) \equiv \text{const} > 0$.

4. There is a totally real subbundle ℓ of the trivial bundle $\partial\Sigma \times \mathbb{C} \rightarrow \partial\Sigma$ and a section $\zeta : \partial\Sigma \rightarrow \partial\Sigma \times \mathbb{C}$ transverse to ℓ with the following property at each component $\gamma_j \subset \partial\Sigma$. Let $L_0 \in \mathcal{F}_j$ be the totally real submanifold such that $\tilde{u}_0(\gamma_j) \subset L_0$, and denote nearby leaves of the foliation \mathcal{F}_j by L_τ for $\tau \in (-1, 1)$. Then for all $z \in \gamma_j$, $v \in B_\epsilon^2(0)$ and τ close to 0,

$$\Psi(z, v) \in L_\tau \iff v \in \ell_z + \tau\zeta(z)$$

Note that the restriction of Ψ to $\dot{\Sigma} \times B_\epsilon^2(0)$ is an embedding if all asymptotic limits are simply covered, but self-intersections appear near any puncture where the orbit is multiply covered.

Proof. In principle, Ψ is constructed simply by exponentiating nonzero sections of the normal bundle $\nu\tilde{u}_0$, but we must be careful about how this bundle is constructed and trivialized near the punctures and boundary.

We recall first the construction from [HWZ99] in the neighborhood of a puncture $z_0 \in \Gamma^\pm$. This neighborhood is identified with one of the half-cylinders Z^\pm via the cylindrical coordinates $(s, t) \in \mathbb{R} \times S^1$. Since \tilde{u}_0 is proper, we may assume $\tilde{u}_0(Z^\pm) \subset E_\pm$ and $\hat{J} = \tilde{J}_\pm$; thus the target looks like part of a symplectization $\mathbb{R} \times M$, with $M = M_\pm$, $\lambda = \lambda_\pm$, $J = J_\pm$ and $\tilde{J} = \tilde{J}_\pm$. The map $\tilde{u}_0 : Z^\pm \rightarrow \mathbb{R} \times M$ extends continuously to $\bar{u}_0 : \bar{Z}^\pm \rightarrow [-\infty, \infty] \times M$ by

$$\bar{u}_0(\pm\infty, t) = (\pm\infty, x_0(Qt)),$$

where $x_0 : \mathbb{R} \rightarrow M$ is a closed Reeb orbit with period $T = |Q|$. The data λ and J define a natural \tilde{J} -invariant and \mathbb{R} -invariant metric g on $\mathbb{R} \times M$, by requiring that

$$\{\partial_a, X_\lambda, Y, JY\}$$

be an orthonormal frame, where $Y \in \xi$ satisfies $|Y|_g^2 = d\lambda(Y, JY) = 1$. Using this metric to define the normal bundle $\nu\tilde{u}_0$ near $z_0 \in \Gamma$, an orthonormal frame for $\nu\tilde{u}_0$ is provided by the two vector fields

$$\begin{aligned} n(s, t) &= \frac{1}{|\tilde{u}_s|} \left(|\pi_\lambda u_s| \partial_a - \lambda(u_t) \frac{\pi_\lambda u_s}{|\pi_\lambda u_s|} + \lambda(u_s) \frac{\pi_\lambda u_t}{|\pi_\lambda u_t|} \right), \\ m(s, t) &= \tilde{J}(\tilde{u}(s, t))n(s, t), \end{aligned}$$

with all norms defined with respect to the metric g . It is shown in [HWZ99] that as $s \rightarrow \pm\infty$,

$$n(s, t) \rightarrow \hat{e}(t) := \frac{e(t)}{|e(t)|} \quad (4.5.1)$$

uniformly with all derivatives, where $e(t) \in \xi_{\tilde{u}(\pm\infty, t)}$ defines an eigenfunction of the asymptotic operator \mathbf{A}_{z_0} , corresponding to the eigenvalue that describes the exponential approach of $\tilde{u}(s, t)$ to its asymptotic limit (cf. Appendix A).

One can identify a neighborhood of $P_0 = x_0(\mathbb{R})$ in M with a neighborhood of $S^1 \times \{0\}$ in $S^1 \times \mathbb{R}^2$, choosing coordinates $(\theta, x, y) \in S^1 \times \mathbb{R}^2$ such that $\lambda = f(d\theta + xdy)$ for some positive smooth function f which is constant and has vanishing first derivative on $S^1 \times \{0\}$. Moreover, if P_0 belongs to a Morse-Bott family $\{P_\tau\}_{\tau \in (-1, 1)}$, we can assume that $P_\tau = \{(\theta, \tau, 0) \mid \theta \in S^1\}$ and f is constant on $\{y = 0\}$, hence $\lambda(\partial_\theta)$ equals the same constant everywhere on each closed orbit. These coordinates are constructed in [HWZ96b].

Now define Ψ on $Z^\pm \times B_\epsilon^2(0)$ in the coordinates $(a, \theta, x, y) \in [-\infty, \infty] \times M_\pm$ by

$$\Psi(s, t, \alpha + i\beta) = \tilde{u}_0(s, t) + \alpha n(s, t) + \beta m(s, t).$$

Observe that this extends continuously to $\overline{Z}^\pm \times B_\epsilon^2(0)$, with

$$\Psi(\pm\infty, t, \alpha + i\beta) = (\pm\infty, x_0(Qt) + \alpha\hat{e}(t) + \beta J\hat{e}(t)).$$

Clearly $\bar{J} = \Psi^* \hat{J}$ has the desired form along the zero section $\dot{\Sigma} \times \{0\}$, and it also has the correct asymptotic behavior as a consequence of (4.5.1). We refer to [HWZ99] for further details.

Turning to the situation near a component $\gamma_j \subset \partial\Sigma$, let $L_0 \in \mathcal{F}_j$ be the totally real submanifold which contains $\tilde{u}_0(\gamma_j)$, and denote nearby surfaces in the foliation by L_τ , with τ a real parameter. Recall that the union of the surfaces L_τ forms a 3-dimensional hypersurface $H_j \subset W$. We define a complex line bundle

$$\eta \rightarrow \gamma_j$$

by choosing $\eta_z \subset T_{\tilde{u}_0(z)}W$ to be the unique complex line in $T_{\tilde{u}_0(z)}H_j$ for each $z \in \gamma_j$. By assumption \tilde{u}_0 is transverse to H_j at γ_j , thus $\eta_z \neq \text{im } d\tilde{u}_0(z)$, and since both are

complex subspaces, they are transverse. We will define the normal bundle $\nu\tilde{u}_0$ so that it matches η over the boundary. Observe that the totally real condition implies L_0 and η are transverse within H_j , so their intersection defines a real subbundle

$$\ell_N = \eta \cap TL_0 \subset \eta \rightarrow \gamma_j.$$

We claim ℓ_N is orientable; or equivalently, $\hat{J}\ell_N$ is orientable. The latter is transverse to L_0 , and thus isomorphic to the normal bundle of L_0 within H_j , restricted over $\tilde{u}_0(\gamma_j)$. This bundle is trivial, by the construction of H_j .

We can choose a nonzero section $\sigma : \gamma_j \rightarrow \ell_N$ and use it to define a complex linear trivialization $\eta \rightarrow \gamma_j \times \mathbb{C}$, sending $\sigma(z)$ to $(z, 1)$. Now use this trivialization to define a tubular neighborhood embedding $\Psi_0 : \gamma_j \times B_\epsilon^2(0) \rightarrow H_j$ onto a neighborhood \mathcal{U} of $\tilde{u}_0(\gamma_j)$ in H_j . Clearly this embedding can be chosen so that

$$\Psi_0(\gamma_j \times (\mathbb{R} \cap B_\epsilon^2(0))) = L_0 \cap \mathcal{U}.$$

With a slight modification, and possibly choosing smaller neighborhoods, one can also ensure that

$$\Psi_0(\gamma_j \times ((\mathbb{R} + i\tau) \cap B_\epsilon^2(0))) = L_\tau \cap \mathcal{U}$$

for all τ close to 0.

Let $A \subset \Sigma$ be a small neighborhood of γ_j , conformally equivalent to an annulus $(-\delta, 0] \times S^1$. Then since $\tilde{u}_0|_A$ is transverse to H_j , we can extend Ψ_0 to an embedding $\Psi : A \times B_\epsilon^2(0) \rightarrow W$ such that $\Psi(z, v) = \Psi_0(z, v)$ for $z \in \gamma_j$ and $\Psi(z, 0) = \tilde{u}_0(z)$. Denoting the coordinates on $B_\epsilon^2(0)$ by $\alpha + i\beta$, it is also easy to arrange that $\hat{J}(\tilde{u}_0(z))\frac{\partial\Psi}{\partial\alpha}(z, 0) = \frac{\partial\Psi}{\partial\beta}(z, 0)$.

We have now defined a map Ψ near the boundary and punctures of $\dot{\Sigma}$ which satisfies all the desired properties. In principle this is the same as choosing a Hermitian metric near $\tilde{u}_0(\dot{\Sigma}) \subset W$ in order to define the normal bundle, then trivializing the normal bundle and defining an embedding via exponentiation. The map Ψ can be extended appropriately over all of $\dot{\Sigma} \times B_\epsilon^2(0)$ if and only if the corresponding trivialization of $\nu\tilde{u}_0$ near the boundary and punctures is extendable over $\dot{\Sigma}$. This may not be the case with the choices we've made, so to finish, pick any of the boundary components or punctures, and working in conformal coordinates $(s, t) \in \mathbb{R} \times S^1$ on some neighborhood, make the replacement

$$\Psi(s, t, v) \longleftarrow \Psi(s, t, e^{2\pi ikt}v),$$

for some integer k . The new Ψ still has all the right properties, and there is a unique choice of k for which the resulting trivialization of $\nu\tilde{u}_0$ extends globally. This allows a global definition of Ψ , and completes the proof of Prop. 4.5.4. \square

Remark 4.5.5. The normal bundle $\nu\tilde{u}_0 \rightarrow \dot{\Sigma}$ was defined above as the image of the trivial bundle $\dot{\Sigma} \times \mathbb{C}$ under $T\Psi$ along $\dot{\Sigma} \times \{0\}$. Due to the splitting of \bar{J} , $\nu\tilde{u}_0$ is thus a complex subbundle of $(\tilde{u}_0^*TW, \hat{J})$. It also extends continuously to a topological complex line bundle

$$\nu\bar{u}_0 \rightarrow \bar{\Sigma},$$

with a smooth structure over the circles $\delta_z \subset \partial\bar{\Sigma}$, such that $\nu\bar{u}_0|_{\delta_z} = \bar{u}_0^*\xi_{\pm}|_{\delta_z}$.

Proposition 4.5.6. Assume \tilde{u}_0 and Ψ are as in Prop. 4.5.4, and let $\tilde{u}_k : \dot{\Sigma} \rightarrow W$ be a sequence of solutions to (\mathbf{BP}') , converging to \tilde{u}_0 in $\mathcal{M}(\hat{J}, L)$. Then for sufficiently large k , there are unique smooth functions $v_k : \dot{\Sigma} \rightarrow B_\epsilon^2(0)$ and diffeomorphisms $\varphi_k : \dot{\Sigma} \rightarrow \dot{\Sigma}$ such that $\Psi(z, v_k(z)) = \tilde{u}_k \circ \varphi_k(z)$ for all $z \in \dot{\Sigma}$, and $v_k \rightarrow 0$ in $C_{\text{loc}}^\infty(\dot{\Sigma}, \mathbb{C})$.

There are also continuous extensions $\bar{v}_k : \bar{\Sigma} \rightarrow B_\epsilon^2(0)$ and $\bar{\varphi}_k : \bar{\Sigma} \rightarrow \bar{\Sigma}$ such that $\bar{u}_k \circ \bar{\varphi}_k(z) = \Psi(z, \bar{v}_k(z))$ for all $z \in \bar{\Sigma}$, and $\bar{v}_k \rightarrow 0$ in $C^0(\bar{\Sigma}, \mathbb{C})$.

Proof. Without loss of generality, we may assume $\tilde{u}_k \rightarrow \tilde{u}_0$ in $C_{\text{loc}}^\infty(\dot{\Sigma}, W)$ and $\bar{u}_k \rightarrow \bar{u}_0$ in $C^0(\bar{\Sigma}, \bar{W})$. Since \bar{u}_k converges uniformly and $\Psi(\bar{\Sigma} \times B_\epsilon^2(0))$ covers a neighborhood of $\bar{u}_0(\bar{\Sigma})$ in \bar{W} , there are functions $f_k : \bar{\Sigma} \rightarrow \bar{\Sigma}$ and $g_k : \bar{\Sigma} \rightarrow B_\epsilon^2(0)$ such that

$$\bar{u}_k(z) = \Psi(f_k(z), g_k(z)) \quad \text{for all } z \in \bar{\Sigma}.$$

These are uniquely determined for z outside a neighborhood of the punctures, and they extend uniquely if we require them to be continuous. Then $f_k \rightarrow \text{Id}$ and $g_k \rightarrow 0$ uniformly on $\bar{\Sigma}$; both are also smooth on $\dot{\Sigma}$, with convergence to Id and 0 respectively in $C_{\text{loc}}^\infty(\dot{\Sigma})$. For sufficiently large k , we can therefore assume f_k is a homeomorphism of $\bar{\Sigma}$ and a diffeomorphism of $\dot{\Sigma}$. The desired functions are then $\varphi_k = f_k^{-1}$, $v_k = g_k \circ f_k^{-1}$. \square

The upshot is that we can describe solutions close to \tilde{u}_0 as sections of a trivial complex line bundle, satisfying a linear boundary condition.

4.5.2 Functional analytic setup

The aim of this section is to describe a neighborhood of \tilde{u}_0 in $\mathcal{M}(\hat{J}, L)$ as the zero set of a smooth section of a Banach space bundle. We begin by defining the function spaces that will be needed. These include both Sobolev and Hölder spaces—the latter are more convenient for the nonlinear operator, and elliptic regularity theory will allow us to return to the L^p -setting for the linear analysis. We also must introduce exponential weights to deal with the degeneracy at Morse-Bott punctures.

Banach spaces of sections

To define these spaces for bundles $E \rightarrow \dot{\Sigma}$, it helps to know that E extends continuously to a bundle over $\overline{\Sigma}$, but this is not quite enough. The noncompactness of $\dot{\Sigma}$ necessitates some notion of “asymptotic smoothness”.

Assume Σ is any compact oriented smooth surface with boundary, and $\dot{\Sigma} = \Sigma \setminus \Gamma$ has finitely many interior punctures. A class of preferred embeddings $Z^+ = [0, \infty) \times S^1 \hookrightarrow \dot{\Sigma}$ is defined by choosing any puncture $z \in \Gamma$ and a diffeomorphism $\varphi : (\mathcal{U}, z) \rightarrow (\mathbb{D}, 0)$, where $\mathcal{U} \subset \Sigma$ is a closed subset whose interior contains one of the punctures. We then compose this with the diffeomorphism

$$Z^+ \rightarrow \dot{\mathbb{D}} = \mathbb{D} \setminus \{0\} : (s, t) \mapsto e^{-2\pi(s+it)}.$$

A smooth embedding $\psi : Z^+ \rightarrow \dot{\Sigma}$ constructed in this way will be referred to as a *cylindrical coordinate* system for $\dot{\Sigma}$. We will occasionally also use cylindrical coordinate systems in the *negative* half-cylinder $Z^- = (-\infty, 0] \times S^1$; all statements about Z^+ can be adapted for Z^- as well.

Lemma 4.5.7. *Let $\psi_1 : Z^+ \rightarrow \dot{\Sigma}$ and $\psi_2 : Z^+ \rightarrow \dot{\Sigma}$ be two cylindrical coordinate systems near the same puncture, and consider the coordinate transformation $h = \psi_1^{-1} \circ \psi_2 : [R, \infty) \times S^1 \rightarrow [0, \infty) \times S^1$ for some $R \geq 0$. Then for any multiindex β with $|\beta| \geq 1$, $|\partial^\beta h|$ is globally bounded on $[R, \infty) \times S^1$. Writing $h(s, t) = (\sigma, \tau)$, there is a similar C^∞ -bound on the function*

$$f(s, t) = e^{c(\sigma(s,t)-s)}$$

for any $c \in \mathbb{R}$.

Proof. If $\psi : [0, \infty) \times S^1 \rightarrow \dot{\mathbb{D}} : (s, t) \mapsto e^{-2\pi(s+it)}$, then we can write $h = \psi^{-1} \circ \varphi \circ \psi$ for some diffeomorphism φ between neighborhoods of 0 in \mathbb{D} , with $\varphi(0) = 0$. Denote by $D^k \varphi(z)$ the k th derivative of φ at z , considered as a real multilinear map $\mathbb{C} \otimes \dots \otimes \mathbb{C} \rightarrow \mathbb{C}$. Then if $\psi(s, t) = z \in \dot{\mathbb{D}}$, we compute

$$\partial_s h(s, t) = \frac{1}{\varphi(z)} D\varphi(z)z, \quad \partial_t h(s, t) = \frac{1}{\varphi(z)} D\varphi(z)iz.$$

Both are clearly bounded since $\frac{z}{\varphi(z)}$ is bounded; this follows from the differentiability of φ and nonsingularity of $D\varphi(0)$.

We now proceed inductively and for $n \in \mathbb{N}$, denote by \mathcal{A}_n any finite linear combination of functions $[R, \infty) \times S^1 \rightarrow \mathbb{C}$ of the form

$$\frac{1}{[\varphi(z)]^m} [D^{j_1} \varphi(z)(\kappa z, \dots, \kappa z)] \dots [D^{j_m} \varphi(z)(\kappa z, \dots, \kappa z)]$$

where again $z = \psi(s, t)$, $m \in \{1, \dots, n\}$, $j_1 + \dots + j_m = n$ and each κ is either 1 or i . Also denote

$$\tilde{\mathcal{A}}_n = \sum_{k=1}^n \mathcal{A}_k.$$

Then for any first order differential operator ∂ , we find $\partial \tilde{\mathcal{A}}_n = \tilde{\mathcal{A}}_{n+1}$, and clearly $\partial_s h$ and $\partial_t h$ are both $\tilde{\mathcal{A}}_1$. Thus $\partial^\beta h = \tilde{\mathcal{A}}_{|\beta|}$. All of these expressions are bounded, again resulting from the fact that $|z|/|\varphi(z)|$ is bounded and $j_1 + \dots + j_m = n \geq m$. This proves the bound for $\partial^\beta h$ with $|\beta| \geq 1$.

In light of this, the bound on all derivatives of f will follow from a C^0 -bound, and we observe

$$e^{c(\sigma-s)} = [e^{2\pi(\sigma-s)}]^{c/2\pi} = \left(\frac{e^{-2\pi s}}{e^{-2\pi\sigma}} \right)^{c/2\pi} = \left(\frac{|z|}{|\varphi(z)|} \right)^{c/2\pi} \leq C.$$

□

Definition 4.5.8. *Let $E \rightarrow \bar{\Sigma}$ be a complex vector bundle with a C^0 -structure that restricts to a C^∞ -structure over each of $\dot{\Sigma}$ and $\bar{\Sigma} \setminus \dot{\Sigma}$, and assume we are given local trivializations over a neighborhood of each connected component of $\bar{\Sigma} \setminus \dot{\Sigma}$. We call this an asymptotically smooth structure if for every transition map*

$$g : [R, \infty) \times S^1 \rightarrow GL(n, \mathbb{C})$$

expressed in cylindrical coordinates, $|\partial^\beta g|$ is bounded for every multiindex β .

Note that this notion is well defined due to Lemma 4.5.7. Also due to the lemma, the tangent bundle $T\dot{\Sigma} \rightarrow \dot{\Sigma}$ is an example of an asymptotically smooth bundle: near the punctures we can choose preferred trivializations defined by the cylindrical coordinate systems. There is a natural extension of $T\dot{\Sigma}$ to a C^0 -bundle $\overline{T\Sigma} \rightarrow \bar{\Sigma}$; we should emphasize however that this is *not* the tangent bundle of $\bar{\Sigma}$, which is not defined.

We can now define Hölder and Sobolev norms for sections of an asymptotically smooth vector bundle. Choose a finite open cover $\bigcup_j \mathcal{U}_j = \Sigma$ such that each set \mathcal{U}_j contains at most one puncture, and denote $\dot{\mathcal{U}}_j = \mathcal{U}_j \setminus (\Gamma \cap \mathcal{U}_j)$. Assume that for each set $\mathcal{U}_j \subset \dot{\Sigma}$, there is a smooth chart $\varphi_j : \mathcal{U}_j \rightarrow \Omega_j \subset \mathbb{H}$, where \mathbb{H} is the closed upper half plane in \mathbb{C} and Ω_j is an open subset. If \mathcal{U}_j contains a puncture, assume instead that $\varphi_j : \dot{\mathcal{U}}_j \rightarrow \Omega_j \subset Z^+$ defines a cylindrical coordinate system, as defined above. Furthermore, suppose we have local trivializations $\Phi_j : E|_{\mathcal{U}_j} \rightarrow \mathcal{U}_j \times \mathbb{C}^n$ that define an asymptotically smooth structure, and choose a partition of unity

$\{\alpha_j : \Sigma \rightarrow [0, 1]\}$ subordinate to $\{\mathcal{U}_j\}$. Then for any integer $k \geq 0$ and a section $v : \dot{\Sigma} \rightarrow E$, we define

$$\|v\|_{C^k(E)} = \sum_j \|\text{pr}_2 \circ \Phi_j \circ (\alpha_j v) \circ \varphi_j^{-1}\|_{C^k(\Omega_j)}. \quad (4.5.2)$$

The Hölder norms $\|\cdot\|_{C^{k+\alpha}(E)}$ for $\alpha \in (0, 1)$ and Sobolev norms $\|\cdot\|_{W^{k,p}(E)}$ for $p \geq 1$ can be expressed similarly, thus defining spaces $C^{k+\alpha}(E)$ and $W^{k,p}(E)$. There is potential confusion when $\alpha = 0$, so we use the notation

$$C_b^k(E) = C^{k+0}(E) \subset C^k(E)$$

to specify that we mean sections with *bounded* derivatives up to order k ; this is a proper subset of $C^k(E)$ if $\dot{\Sigma}$ is noncompact. A standard argument shows that $C^{k+\alpha}(E)$ and $W^{k,p}(E)$ are all Banach spaces, and different choices of charts, trivializations etc. lead to equivalent norms as long as the derivatives of the transition maps are bounded. The notation $C_{\text{loc}}^{k+\alpha}(E)$ and $W_{\text{loc}}^{k,p}(E)$ will be used for the Fréchet spaces of sections that are of the corresponding class on every compact subset of $\dot{\Sigma}$. Note that these are well defined without assuming $E \rightarrow \bar{\Sigma}$ to be asymptotically smooth.

We are interested in certain closed subspaces of $C^{k+\alpha}(E)$ consisting of sections that decay near the punctures. Denote $Z_R^+ = [R, \infty) \times S^1$ for $R \geq 0$, so $Z^+ = Z_0^+$. For any integer $k \geq 0$ and real number $\alpha \in [0, 1)$, we say that a function $f : Z^+ \rightarrow \mathbb{C}^n$ is in $C_\infty^{k+\alpha}(Z^+)$, if

$$\|f\|_{C^{k+\alpha}(Z_R^+)} \rightarrow 0 \quad \text{as } R \rightarrow \infty.$$

Using Lemma 4.5.7 and the asymptotically smooth structure of $E \rightarrow \dot{\Sigma}$, one can easily show that this concept also makes sense for sections $v \in C^{k+\alpha}(E)$.

Definition 4.5.9. $C_\Gamma^{k+\alpha}(E)$ is the space of sections $v \in C^{k+\alpha}(E)$ such that in some trivialization Φ and cylindrical coordinates (s, t) near each puncture, the function $\text{pr}_2 \circ \Phi \circ v(s, t)$ is of class $C_\infty^{k+\alpha}$.

This is a closed subspace of $C^{k+\alpha}(E)$. Observe that there are continuous inclusions $C_\Gamma^{k+1+\alpha}(E) \subset C_\Gamma^{k+\alpha}(E)$, and any section in $C_\Gamma^\alpha(E)$ extends continuously to a section $\bar{\Sigma} \rightarrow E$ that vanishes on $\bar{\Sigma} \setminus \dot{\Sigma}$.

Finally we introduce spaces of sections that decay (or grow) exponentially near the punctures. As short-hand notation, let X represent any of the symbols $C^{k+\alpha}$, $C_\Gamma^{k+\alpha}$, $C_\infty^{k+\alpha}$ or $W^{k,p}$. Then for a function $f : Z^+ \rightarrow \mathbb{C}^n$ and a number $\epsilon \in \mathbb{R}$, we say $f \in X^\epsilon(Z^+)$ if the function $f^\epsilon(s, t) := e^{\epsilon s} f(s, t)$ is in $X(Z^+)$, and define a norm

$$\|f\|_{X^\epsilon(Z^+)} = \|e^{\epsilon s} f\|_{X(Z^+)}.$$

Such functions decay exponentially as $s \rightarrow \infty$ if $\epsilon > 0$; on the other hand if $\epsilon < 0$, $X^\epsilon(Z^+)$ contains functions that *grow* exponentially. This will turn out to be useful.

In the following, we label the punctures

$$\Gamma = \{z_1, \dots, z_N\},$$

and choose associated cylindrical coordinate systems $(s, t) \in Z^+$ with local trivializations Φ_1, \dots, Φ_N over the corresponding coordinate neighborhoods.

Definition 4.5.10. *For any $\epsilon = (\epsilon_1, \dots, \epsilon_N) \in \mathbb{R}^N$, $C_\Gamma^{k+\alpha, \epsilon}(E)$ is the space of sections $v \in C_{\text{loc}}^{k+\alpha}(E)$ such that in the trivializations Φ_j and cylindrical coordinates (s, t) near each puncture $z_j \in \Gamma$, $\text{pr}_2 \circ \Phi_j \circ v(s, t)$ is of class $C_\infty^{k+\alpha, \epsilon_j}$, i.e. the function $e^{\epsilon_j s} \cdot \text{pr}_2 \circ \Phi_j \circ v(s, t)$ is of class $C_\infty^{k+\alpha}$. A norm is defined on $C_\Gamma^{k+\alpha, \epsilon}(E)$ by the prescription of (4.5.2) the same as for $C_\Gamma^{k+\alpha}(E)$, except replacing $\| \cdot \|_{C^{k+\alpha}(Z^+)}$ with $\| \cdot \|_{C^{k+\alpha, \epsilon_j}(Z^+)}$ for a neighborhood of each puncture.*

That this is well defined follows from the second statement in Lemma 4.5.7. Indeed, it must be verified that for any transformation $h : [s_0, \infty) \times S^1 \rightarrow [0, \infty) \times S^1$ of cylindrical coordinate systems, there is a constant $C > 0$ and a function $R(r)$ with $\lim_{r \rightarrow \infty} R(r) = \infty$ such that for all $f : Z^+ \rightarrow \mathbb{C}^n$ and $r \geq s_0$,

$$\|e^{\epsilon s}(f \circ h)\|_{C^{k+\alpha}(Z_r^+)} \leq C \|e^{\epsilon s} f\|_{C^{k+\alpha}(Z_{R(r)}^+)}.$$

This follows from the C^∞ -bound for $e^{\epsilon(\sigma(s,t)-s)}$ where $(\sigma, \tau) := h^{-1}(s, t)$, since

$$e^{\epsilon s}(f \circ h)(s, t) = (e^{\epsilon \sigma(s,t)} f) \circ h(s, t) = (e^{\epsilon(\sigma(s,t)-s)} e^{\epsilon s} f) \circ h(s, t).$$

The spaces $C^{k+\alpha, \epsilon}(E)$ and $W^{k,p, \epsilon}(E)$ for $\epsilon \in \mathbb{R}^N$ are defined analogously, and all of them are Banach spaces.

In addition to these, there are natural Fréchet spaces defined by

$$C_b^\infty(E) = \bigcap_{k=0}^{\infty} C_b^k(E), \quad C_\Gamma^\infty(E) = \bigcap_{k=0}^{\infty} C_\Gamma^k(E), \quad C_\Gamma^{\infty, \epsilon}(E) = \bigcap_{k=0}^{\infty} C_\Gamma^{k, \epsilon}(E).$$

Thus if $\epsilon = (\epsilon_1, \dots, \epsilon_N)$ with all $\epsilon_j > 0$, there are continuous inclusions

$$C_\Gamma^{\infty, \epsilon}(E) \subset C_\Gamma^\infty(E) \subset C_b^\infty(E) \subset C_\Gamma^{\infty, -\epsilon}(E).$$

The last space on the right contains sections that grow exponentially at every puncture. We will also use the standard notation $C_0^\infty(E)$ for smooth sections with compact support in $\dot{\Sigma}$. Note that these need not vanish on $\partial\Sigma$.

Manifolds of maps

For any manifold W , it is clear what is meant by $C_{\text{loc}}^{k+\alpha}(\dot{\Sigma}, W)$; this is not a vector space but a nonlinear space of continuous maps $\dot{\Sigma} \rightarrow W$, with a natural topology defined by considering $C^{k+\alpha}$ -norms in charts for both $\dot{\Sigma}$ and W . To define $W_{\text{loc}}^{k,p}(\dot{\Sigma}, W)$, one must require $kp > 2$, so that the coordinate transformation $u \mapsto \varphi \circ u$ for smooth φ is continuous in the Sobolev space topology.

H. Eliasson described in [El67] a general formalism with which one can define natural smooth Banach manifold structures for $C^{k+\alpha}(\Sigma, W)$ and $W^{k,p}(\Sigma, W)$ if Σ is compact. These notions can be extended to noncompact domains under certain conditions; such a generalization for maps on punctured Riemann surfaces is carried out for instance in the appendix of [Sch96]. We will not delve into the details here, but only mention that one can use ideas analogous to the asymptotically smooth structures defined above in order to define a Banach manifold $C^{k+\alpha}(\dot{\Sigma}, W)$, which contains maps $\dot{\Sigma} \rightarrow W$ of class $C_{\text{loc}}^{k+\alpha}$ that have nice asymptotic behavior near the punctures. Generalizing Eliasson's formalism to this case, it is not hard to construct Banach space bundles over $C^{k+\alpha}(\dot{\Sigma}, W)$ and prove smoothness for certain natural sections that arise.

Mixed boundary conditions on the normal bundle

Returning to the solution $\tilde{u}_0 \in \mathcal{M}(\hat{J}, L)$ and the associated immersion $\Psi : \dot{\Sigma} \times B_\epsilon^2(0) \rightarrow W$, we can now improve Prop. 4.5.6 as follows. Observe that the normal bundle $\nu\tilde{u}_0 \rightarrow \bar{\Sigma}$ has an asymptotically smooth structure determined by the vector fields $n(s, t)$ and $m(s, t)$ from the proof of Prop. 4.5.4; indeed, our choice of trivialization was unique up to a rotation near infinity, which has infinitely many bounded derivatives. Using $T\Psi$ to identify $\nu\tilde{u}_0$ with $\dot{\Sigma} \times \mathbb{C}$, we can regard the domain of Ψ as an open neighborhood \mathcal{V}_0 of the zero section in $\nu\tilde{u}_0$, and define subsets

$$C_\Gamma^{k+\alpha, \epsilon}(\mathcal{V}_0) = \{v \in C_\Gamma^{k+\alpha, \epsilon}(\nu\tilde{u}_0) \mid v(z) \in \mathcal{V}_0 \text{ for all } z \in \dot{\Sigma}\} \subset C_\Gamma^{k+\alpha, \epsilon}(\nu\tilde{u}_0),$$

which are open if all the exponential weights ϵ_j are nonnegative. Now for $\tilde{u} \in \mathcal{M}(\hat{J}, L)$ sufficiently close to \tilde{u}_0 , let $v_{\tilde{u}} : \dot{\Sigma} \rightarrow \mathcal{V}_0$ denote the unique smooth section of $\nu\tilde{u}_0$ such that $\Psi(z, v_{\tilde{u}}(z))$ parametrizes the image of \tilde{u} . By Prop. 4.5.4, there is a totally real subbundle $\ell \subset \nu\tilde{u}_0 \rightarrow \partial\Sigma$ and a smooth section $\zeta : \partial\Sigma \rightarrow \nu\tilde{u}_0|_{\partial\Sigma}$ transverse to ℓ which corresponds to the variable boundary condition satisfied by $\tilde{u} \in \mathcal{M}(\hat{J}, L)$. In particular, for any space of sections $X(\nu\tilde{u}_0)$ that embeds continuously into $C^0(\nu\tilde{u}_0)$, we can define the closed subspaces

$$\begin{aligned} X_\ell(\nu\tilde{u}_0) &= \{v \in X(\nu\tilde{u}_0) \mid v(\partial\Sigma) \subset \ell\}, \\ X_{\ell, \zeta}(\nu\tilde{u}_0) &= \{v \in X(\nu\tilde{u}_0) \mid v(\gamma_j) \subset \ell + \tau_j \zeta \text{ for any } \tau_j \in \mathbb{R}\}, \end{aligned}$$

where $\gamma_j \subset \partial\Sigma$ denotes the connected components. Clearly then, $v_{\tilde{u}} \in C_{\ell_\zeta}^\infty(\nu\tilde{u}_0)$.

If all asymptotic limits of \tilde{u}_0 are nondegenerate, then \tilde{u} necessarily has the same limits, and the transversal approach is exponentially fast, as described in Appendix A. From this we deduce $v_{\tilde{u}} \in C_{\Gamma, \ell_\zeta}^{\infty, \epsilon}(\mathcal{V}_0)$ for any $\epsilon = (\epsilon_1, \dots, \epsilon_N)$ with $0 \leq \epsilon_j < c$ for some constant $c > 0$. In fact, if $\tilde{u}_k \rightarrow \tilde{u}_0$ in $\mathcal{M}(\hat{J}, L)$, then it follows from the uniform convergence and arguments in [HWZ96a] that the exponential approach can be estimated *uniformly* in k . Combining this fact with the C_{loc}^∞ -convergence of $v_{\tilde{u}_k}$ to 0, we find

$$v_{\tilde{u}_k} \rightarrow 0 \quad \text{in} \quad C_\Gamma^{\infty, \epsilon}(\nu\tilde{u}_0)$$

if all ϵ_j are sufficiently small.

We must modify this somewhat if there are Morse-Bott asymptotic limits. Suppose the limit of \tilde{u}_0 at $z_j \in \Gamma^\pm$ is $P_0 \subset M_\pm$, which is part of a 1-parameter Morse-Bott family of orbits $\{P_\tau\}_{\tau \in (-1, 1)}$. Describe a neighborhood of z_j in cylindrical coordinates $(s, t) \in Z^+$. Then for some $s_0 > 0$ and all τ in a neighborhood of 0, we can find a smooth family of smooth sections

$$w_\tau : [s_0, \infty) \times S^1 \rightarrow \mathcal{V}_0$$

such that $\Psi(s, t, w_\tau(s, t))$ parametrizes half of the orbit cylinder over P_τ . Extend w_τ to $[0, \infty) \times S^1$ by multiplication with a cutoff function such that $w_\tau(s, t) = 0$ for s near 0. This then extends to a global section of $\nu\tilde{u}_0$, and is in $C_b^\infty(\mathcal{V}_0)$. Repeating this construction for all punctures that have Morse-Bott limits, one obtains a finite dimensional submanifold

$$Y \subset C_b^\infty(\mathcal{V}_0),$$

containing a smooth family of sections $\{w_\tau\}$ that are each supported in a neighborhood of the punctures and parametrize orbit cylinders near infinity. Here we assume the parameter τ belongs to an open neighborhood of zero in some Euclidean space, and w_0 is the unique section in Y that decays to zero at all the punctures.

The argument above for the nondegenerate case now generalizes as follows:

Proposition 4.5.11. *Suppose $\tilde{u}_k \rightarrow \tilde{u}_0$ in $\mathcal{M}(\hat{J}, L)$. Then there is a constant $c > 0$ such that for sufficiently large k and any $\epsilon = (\epsilon_1, \dots, \epsilon_N)$ with each $\epsilon_j \in [0, c)$, we have*

$$v_{\tilde{u}_k} = v_k + w_{\tau_k}$$

for unique sections $v_k \in C_{\Gamma, \ell_\zeta}^{\infty, \epsilon}(\mathcal{V}_0)$ and $w_{\tau_k} \in Y$, with $v_k \rightarrow 0$ in $C_{\Gamma, \ell_\zeta}^{\infty, \epsilon}(\nu\tilde{u}_0)$ and $\tau_k \rightarrow 0$.

The nonlinear operator

Any section $v \in C^1(\mathcal{V}_0)$ may be regarded as a C^1 -embedding $v : \dot{\Sigma} \rightarrow \mathcal{V}_0$. Then $\Psi \circ v : \dot{\Sigma} \rightarrow W$ defines a \hat{J} -holomorphic curve if and only if the tangent spaces of the embedding v are invariant under the almost complex structure $\bar{J} = \Psi^* \hat{J}$ on $\mathcal{V}_0 \subset \nu\tilde{u}_0$, i.e. v is a complex curve. In this case, elliptic regularity theory implies that v is actually smooth. Following [HWZ99], we now write down an operator to detect all sections $v : \dot{\Sigma} \rightarrow \mathcal{V}_0$ that define complex curves in (\mathcal{V}_0, \bar{J}) .

The general framework is as follows: let S be an oriented surface and (W, J) an almost complex 4-manifold. Denote by $\Lambda^2 TS \rightarrow S$ the second exterior product of the bundle $TS \rightarrow S$, so for $z \in S$, the fiber $\Lambda^2 T_z S$ is a real 1-dimensional vector space spanned by $h \wedge k$ for any two linearly independent vectors $h, k \in T_z S$. Similarly, there is a 2-dimensional bundle $\Theta \rightarrow W$ defined by

$$\Theta_p = \{\xi \in \Lambda^2 T_p W \mid J\xi = -\xi\},$$

where J acts linearly on $\Lambda^2 TW$ by $J(X \wedge Y) = JX \wedge JY$. Now for any immersion $u : S \rightarrow W$ we define a section of the bundle $\text{Hom}_{\mathbb{R}}(\Lambda^2 TS, u^*\Theta) \rightarrow S$ by

$$\bar{\eta}_J(u)(z) : h \wedge k \mapsto Tu(h) \wedge Tu(k) - JTu(h) \wedge JTu(k)$$

for $z \in S$. One easily checks that u satisfies $J(\text{im } du(z)) = \text{im } du(z)$ if and only if $\bar{\eta}_J(u)(z) = 0$.

For any $\alpha \in (0, 1)$ and $\epsilon = (\epsilon_1, \dots, \epsilon_N)$ with $0 \leq \epsilon_j < c$ for a suitably small constant $c > 0$, define the Banach manifold

$$\mathcal{B} = \{v + w_\tau \mid v \in C_{\Gamma, \ell_\zeta}^{1+\alpha, \epsilon}(\mathcal{V}_0), w_\tau \in Y\}.$$

This could also be defined as the set of sections $v \in C_{\text{loc}}^{1+\alpha}(\mathcal{V}_0)$ with the property that, near each puncture, there is a section $w : Z^+ \rightarrow \mathcal{V}_0$ parametrizing an orbit cylinder near infinity such that $v(s, t) - w(s, t)$ is of class $C_\infty^{1+\alpha, \epsilon}$. Thus the definition doesn't depend on the choice of the sections w_τ . The space \mathcal{B} is a smooth submanifold of $C_{\ell_\zeta}^{1+\alpha}(\mathcal{V}_0)$, and its tangent space at the zero section can be written as

$$T_0\mathcal{B} = C_{\Gamma, \ell_\zeta}^{1+\alpha, \epsilon}(\nu\tilde{u}_0) \oplus T_{w_0}Y,$$

where $T_{w_0}Y$ is a finite dimensional linear subspace of $C_{\ell_\zeta}^{1+\alpha}(\nu\tilde{u}_0)$. There is a smooth Banach space bundle $\mathcal{E} \rightarrow \mathcal{B}$ with fibers

$$\mathcal{E}_v = C_{\Gamma}^{\alpha, \epsilon}(\text{Hom}_{\mathbb{R}}(\Lambda^2 T\dot{\Sigma}, v^*\Theta)).$$

Here v is regarded as a map from $\dot{\Sigma}$ into the subset \mathcal{V}_0 of the total space $\nu\tilde{u}_0$, and Θ is the subbundle of $\Lambda^2 T\mathcal{V}_0 \rightarrow \mathcal{V}_0$ on which \bar{J} acts by negation. For the definition

to make sense, we must observe that the asymptotic behavior of v and \bar{J} gives the bundle $v^*\Theta \rightarrow \dot{\Sigma}$ an asymptotically smooth structure, which then determines an asymptotically smooth structure on $\text{Hom}_{\mathbb{R}}(\Lambda^2 T\dot{\Sigma}, v^*\Theta) \rightarrow \dot{\Sigma}$.

Proposition 4.5.12. *For any $v \in \mathcal{B}$, the section of $\text{Hom}_{\mathbb{R}}(\Lambda^2 T\dot{\Sigma}, v^*\Theta)$ defined by*

$$\mathbf{F}(v) = \bar{\eta}_{\bar{J}}(v) \in \Gamma(\text{Hom}_{\mathbb{R}}(\Lambda^2 T\dot{\Sigma}, v^*\Theta))$$

is of class $C_{\Gamma}^{\alpha, \epsilon}$. This defines a smooth section

$$\mathbf{F} : \mathcal{B} \rightarrow \mathcal{E}$$

of the Banach space bundle $\mathcal{E} \rightarrow \mathcal{B}$.

Proof. Using the asymptotic behavior of \bar{J} as described in Prop. 4.5.4, it's clear that $\mathbf{F}(v)$ is of class $C_{\Gamma}^{\alpha, \epsilon}$ if $v \in C_{\Gamma, \ell_{\zeta}}^{1+\alpha, \epsilon}(\mathcal{V}_0)$. For any $v \in \mathcal{B}$ in general, the key is that v differs by a section in $C_{\Gamma, \ell_{\zeta}}^{1+\alpha, \epsilon}(\mathcal{V}_0)$ from some smooth section $w_{\tau} : \dot{\Sigma} \rightarrow \mathcal{V}_0$ such that $\Psi \circ w$ parametrizes an orbit cylinder near each puncture. Thus $\mathbf{F}(w)$ vanishes near the punctures, and $\mathbf{F}(v) \in C_{\Gamma}^{\alpha, \epsilon}(\text{Hom}_{\mathbb{R}}(\Lambda^2 T\dot{\Sigma}, v^*\Theta))$.

Smoothness follows from the formalism of Eliasson [El67], arguing roughly as follows: first define \mathcal{E} as a vector bundle over the manifold of maps $C^{1+\alpha}(\dot{\Sigma}, \mathcal{V}_0)$, where \mathcal{V}_0 is regarded as a smooth manifold rather than a subset of a vector bundle. The section $u \mapsto \bar{\eta}_{\bar{J}}(u)$ is easily shown to be smooth on this bundle, since, by Eliasson's results, the maps $u \mapsto Tu$ and $u \mapsto J(u)$ define smooth sections of related bundles, and these are then put together by continuous linear multiplication operations in order to form $\bar{\eta}_{\bar{J}}(u)$. Note that the multiplication in the last step requires the Banach algebra structure of C^{α} ; this is why we're not working in $W^{1,p}$.

We deduce that \mathbf{F} is smooth by observing that the space of sections $C^{1+\alpha}(\mathcal{V}_0)$ embeds smoothly into the manifold of maps $C^{1+\alpha}(\dot{\Sigma}, \mathcal{V}_0)$ in a natural way. \square

Clearly $\mathbf{F}(0) = 0$; this is equivalent to the statement that \tilde{u}_0 is \hat{J} -holomorphic. We will spend the next several sections studying the zero set $\mathbf{F}^{-1}(0)$ in a neighborhood of 0 by linear Fredholm analysis. The following summarizes the results of this section thus far.

Proposition 4.5.13. *There is an open neighborhood $\tilde{u}_0 \in \mathcal{U} \subset \mathcal{M}(\hat{J}, L)$ such that \mathcal{U} is homeomorphic to a neighborhood of 0 in $\mathbf{F}^{-1}(0) \subset \mathcal{B}$.*

Proof. By Prop. 4.5.11, any $\tilde{u} \in \mathcal{M}(\hat{J}, L)$ sufficiently close to \tilde{u}_0 is represented by some section $v_{\tilde{u}} \in \mathcal{B}$, and clearly $\mathbf{F}(v_{\tilde{u}}) = 0$. Conversely, any section $v \in \mathbf{F}^{-1}(0)$ represents a \hat{J} -holomorphic curve $\tilde{u} = \Psi \circ v : \dot{\Sigma} \rightarrow W$ with respect to the complex structure $j = \tilde{u}^* \hat{J}$ on $\dot{\Sigma}$. By elliptic regularity theory, \tilde{u} is smooth; it clearly is also asymptotically cylindrical and satisfies the appropriate boundary conditions. \square

If there is a Morse-Bott asymptotic limit, then \mathbf{F} is closely related to another nonlinear operator that will be of interest. Choose an ordering of the punctures $\Gamma = \{z_1, \dots, z_N\}$ such that the subset of punctures with Morse-Bott limits is $\{z_1, \dots, z_p\}$, $p \leq N$. Now recall that the submanifold $Y \subset C_{\ell_\zeta}^{1+\alpha}(\mathcal{V}_0)$ is a smooth p -parameter family of smooth sections

$$w_\tau \in C_b^\infty(\mathcal{V}_0)$$

that parametrize all the cylinders over Morse-Bott orbits near infinity. Denote by $\widehat{Y}^{z_j} \subset Y$ the codimension 1 submanifold containing all $w_\tau \in Y$ that decay to zero near the puncture z_j . Then the Banach manifold

$$\mathcal{B}^{z_j} = \{v + w_\tau \mid v \in C_{\Gamma, \ell_\zeta}^{1+\alpha, \epsilon}(\mathcal{V}_0), w_\tau \in \widehat{Y}^{z_j}\}.$$

is a codimension 1 submanifold of \mathcal{B} , consisting of all the sections in \mathcal{B} that vanish at z_j , and it has tangent space

$$T_0\mathcal{B}^{z_j} = C_{\Gamma, \ell_\zeta}^{1+\alpha, \epsilon}(\nu\tilde{u}_0) \oplus T_{w_0}\widehat{Y}^{z_j},$$

at the zero section. We define the restriction

$$\mathbf{F}_{z_j} = \mathbf{F}|_{\mathcal{B}^{z_j}} : \mathcal{B}^{z_j} \rightarrow \mathcal{E}|_{\mathcal{B}^{z_j}},$$

and observe:

Proposition 4.5.14. *Let $\mathcal{U} \subset \mathcal{M}(\hat{J}, L)$ be the open neighborhood from Prop. 4.5.13, and define \mathcal{U}^{z_j} to be the subset consisting only of solutions $\tilde{u} \in \mathcal{U}$ that have the same asymptotic limit as \tilde{u}_0 at the puncture z_j . Then \mathcal{U}^{z_j} is homeomorphic to a neighborhood of 0 in $\mathbf{F}_{z_j}^{-1}(0) \subset \mathcal{B}^{z_j}$.*

4.5.3 Linearization

Since $\mathbf{F} : \mathcal{B} \rightarrow \mathcal{E}$ is smooth and $\mathbf{F}(0) = 0$, there is a well defined linearization

$$d\mathbf{F}(0) : C_{\Gamma, \ell_\zeta}^{1+\alpha, \epsilon}(\nu\tilde{u}_0) \oplus T_{w_0}Y \rightarrow C_\Gamma^{\alpha, \epsilon}(\text{Hom}_{\mathbb{R}}(\Lambda^2 T\dot{\Sigma}, v_0^*\Theta)),$$

where the embedding $v_0 : \dot{\Sigma} \rightarrow \mathcal{V}_0$ denotes the zero section. A computation in [HWZ99], Sections 3 and 5, shows that $d\mathbf{F}(0)$ is conjugate to a linear Cauchy-Riemann type operator, which takes sections of $\nu\tilde{u}_0 \rightarrow \dot{\Sigma}$ to complex antilinear $\nu\tilde{u}_0$ -valued 1-forms on $\dot{\Sigma}$. Recall that $\nu\tilde{u}_0$ is a complex subbundle of (\tilde{u}^*TW, \hat{J}) , and its complex structure extends naturally over $\overline{\Sigma}$ in an asymptotically smooth way. We thus define a pair of asymptotically smooth complex line bundles

$$E = \nu\tilde{u}_0 \rightarrow \overline{\Sigma}, \quad F = \overline{\text{Hom}_{\mathbb{C}}(T\overline{\Sigma}, E)} \rightarrow \overline{\Sigma}$$

where $\overline{T\Sigma}$ is the natural extension of $(T\dot{\Sigma}, j)$ to an asymptotically smooth complex bundle over $\overline{\Sigma}$, and $\overline{\text{Hom}}_{\mathbb{C}}(V, W)$ denotes the bundle of complex antilinear bundle maps $V \rightarrow W$. Note that for $z \in \Gamma^{\pm}$, the restriction of E to $\delta_z \subset \partial\overline{\Sigma}$ is simply the contact structure ξ_{\pm} over the asymptotic orbit, and this has a symplectic structure defined by $d\lambda_{\pm}$. Thus it makes sense to speak of asymptotically smooth complex trivializations $\Phi : E \rightarrow \overline{\Sigma} \times \mathbb{C}$ that are also “unitary at infinity,” and we shall require this implicitly whenever a trivialization of E is mentioned.

The result from [HWZ99] can now be stated as follows:

Proposition 4.5.15. *The linearization $d\mathbf{F}(0)$ is conjugate to a linear Cauchy-Riemann type operator*

$$\mathbf{L}_{\tilde{u}_0} : C_{\Gamma, \ell_{\zeta}}^{1+\alpha, \epsilon}(E) \oplus T_{w_0}Y \rightarrow C_{\Gamma}^{\alpha, \epsilon}(F).$$

Introducing a global trivialization of E as described above, we can express sections of E as functions $v : \dot{\Sigma} \rightarrow \mathbb{C}$ and write the section $\mathbf{L}_{\tilde{u}_0}v : \dot{\Sigma} \rightarrow \Lambda^{0,1}T^*\dot{\Sigma}$ as

$$(\mathbf{L}_{\tilde{u}_0}v)(z)h = dv(z)h + i dv(z)jh + [C(z)v(z)]h \quad \text{for } h \in T_z\dot{\Sigma}, \quad (4.5.3)$$

where C is a smooth section of $\text{Hom}_{\mathbb{R}}(\dot{\Sigma} \times \mathbb{C}, \Lambda^{0,1}T^*\dot{\Sigma}) \rightarrow \dot{\Sigma}$. In addition, suppose $z \in \Gamma^{\pm}$ has asymptotic limit $x : S^1 \rightarrow M_{\pm}$, and choose cylindrical coordinates $(s, t) \in Z^{\pm}$ for a neighborhood of z . Then

$$[C(s, t) \cdot] \frac{\partial}{\partial s} := S(s, t)$$

defines a smooth map $S : Z^{\pm} \rightarrow \mathcal{L}_{\mathbb{R}}(\mathbb{C})$ with $S(s, t) \rightarrow S_{\infty}(t)$ as $s \rightarrow \pm\infty$ in $C^{\infty}(S^1, \mathcal{L}_{\mathbb{R}}(\mathbb{C}))$, where $S_{\infty}(t)$ is a smooth loop of real 2-by-2 symmetric matrices (we’re identifying $\mathbb{C} = \mathbb{R}^2$), and

$$-J_0 \frac{d}{dt} - S_{\infty}(t)$$

is the asymptotic operator $\mathbf{A}_x : H^1(x^*\xi_{\pm}) \rightarrow L^2(x^*\xi_{\pm})$ associated with the orbit x , expressed in the trivialization.

A trivial corollary is that for a puncture $z \in \Gamma$ with Morse-Bott asymptotic limit, the linearization of the restricted operator $\mathbf{F}_z : \mathcal{B}^z \rightarrow \mathcal{E}|_{\mathcal{B}^z}$ is conjugate to the restriction

$$\mathbf{L}_{\tilde{u}_0, z} := \mathbf{L}_{\tilde{u}_0} : C_{\Gamma, \ell_{\zeta}}^{1+\alpha, \epsilon}(E) \oplus T_{w_0}\hat{Y}^z \rightarrow C_{\Gamma}^{\alpha, \epsilon}(F).$$

Recall that zero is in the spectrum of \mathbf{A}_x if and only if the orbit x is degenerate; in the simple Morse-Bott case, zero is an eigenvalue with multiplicity one.

A general framework

For the rest of this section and the next two, we may assume $E \rightarrow \bar{\Sigma}$ is any asymptotically smooth complex vector bundle with a symplectic structure at $\bar{\Sigma} \setminus \dot{\Sigma}$, $F = \overline{\text{Hom}}_{\mathbb{C}}(\overline{T\Sigma}, E) \rightarrow \bar{\Sigma}$, and

$$\mathbf{L} : C_{\Gamma, \ell_{\zeta}}^{1+\alpha, \epsilon}(E) \oplus Y_0 \rightarrow C_{\Gamma}^{\alpha, \epsilon}(F)$$

is an operator of the type defined in (4.5.3), where the zeroth order term determines an asymptotic operator

$$\mathbf{A}_z : H^1(E|_{\delta_z}) \rightarrow L^2(E_{\delta_z})$$

at each puncture $z \in \Gamma$, as in Prop. 4.5.15. The first factor in the domain consists of sections $v : \dot{\Sigma} \rightarrow E$ of class $C_{\Gamma}^{1+\alpha, \epsilon}$ that satisfy the boundary condition

$$v(\gamma_j) \subset \ell + \tau_j \zeta \quad \text{for any } \tau_j \in \mathbb{R}$$

at each component $\gamma_j \subset \partial\Sigma$, where $\ell \subset E|_{\partial\Sigma}$ is a fixed totally real subbundle and $\zeta : \partial\Sigma \rightarrow E$ is a fixed section with values in $E \setminus \ell$. The factor Y_0 is a finite dimensional subspace of $C_{\ell_{\zeta}}^{1+\alpha}(E)$, spanned by sections

$$\beta_{z_1}, \dots, \beta_{z_p} \in C_b^{\infty}(E),$$

where β_{z_j} is supported near the puncture $z_j \in \Gamma$ and defines a smooth nonzero section on $\delta_{z_j} \subset \partial\bar{\Sigma}$. The subset

$$\{z_1, \dots, z_p\} \subset \{z_1, \dots, z_N\} = \Gamma$$

consists of punctures where the asymptotic operator \mathbf{A}_{z_j} is degenerate, with a one-dimensional kernel. It may or may not include *all* such punctures; in this way our general framework applies to both $\mathbf{L}_{\bar{u}_0}$ and the restricted operators $\mathbf{L}_{\bar{u}_0, z}$.

Operators \mathbf{L} satisfying the criteria stated above will be referred to as *admissible Cauchy-Riemann type operators*. Note that at this stage, $\alpha \in (0, 1)$ and the exponential weights $\epsilon = (\epsilon_1, \dots, \epsilon_N) \in \mathbb{R}^N$ are completely arbitrary; in practice of course we're most interested in the case where each ϵ_j is nonnegative and close to zero.

There are three objectives:

1. Prove that \mathbf{L} is Fredholm for generic weights $\epsilon \in \mathbb{R}^N$.
2. Compute its index.
3. Find criteria for \mathbf{L} to be surjective.

The remainder of this section will address the first issue. The next lemma shows that, for proving the Fredholm property, the finite dimensional factor Y_0 is irrelevant. The proof is a trivial exercise.

Lemma 4.5.16. *Let X and Z be Banach spaces, with $X_0 \subset X$ a closed subspace of finite codimension. Suppose $\mathbf{A} : X \rightarrow Z$ is a bounded linear operator, and denote $\mathbf{A}_0 = \mathbf{A}|_{X_0} : X_0 \rightarrow Z$. Then \mathbf{A} is Fredholm if and only if \mathbf{A}_0 is, and*

$$\text{Ind } \mathbf{A} = \text{Ind } \mathbf{A}_0 + \text{codim } X_0.$$

We aim therefore to prove that the restriction

$$\mathbf{L}' : C_{\Gamma, \ell_\zeta}^{1+\alpha, \epsilon}(E) \rightarrow C_\Gamma^{\alpha, \epsilon}(F)$$

is Fredholm. The next step is to eliminate the exponential weights, which causes a perturbation in the asymptotic operators. Fix a cylindrical coordinate system $(s, t) \in Z^+$ near each puncture $z_j \in \Gamma$ and choose a smooth function $\gamma : \dot{\Sigma} \rightarrow (0, \infty)$ such that

$$\begin{aligned} \gamma &= 0 && \text{outside a neighborhood of } \Gamma, \text{ and} \\ \gamma(s, t) &= \epsilon_j s && \text{for sufficiently large } s \text{ near } z_j \in \Gamma. \end{aligned}$$

This defines a continuous isomorphism

$$\mathbf{W}^\epsilon : C_{\Gamma, \ell_\zeta}^{1+\alpha, \epsilon}(E) \rightarrow C_{\Gamma, \ell_\zeta}^{1+\alpha}(E) : v \mapsto e^\gamma v,$$

and a similar isomorphism $\mathbf{W}^\epsilon : C_\Gamma^{\alpha, \epsilon}(F) \rightarrow C_\Gamma^\alpha(F)$. Note that we may assume \mathbf{W}^ϵ and $\mathbf{W}^{-\epsilon}$ are inverses. Now define an operator conjugate to \mathbf{L}' by

$$\mathbf{L}^\epsilon = \mathbf{W}^\epsilon \mathbf{L}' \mathbf{W}^{-\epsilon} : C_{\Gamma, \ell_\zeta}^{1+\alpha}(E) \rightarrow C_\Gamma^\alpha(F).$$

Proposition 4.5.17. *\mathbf{L}^ϵ is also an admissible Cauchy-Riemann type operator, with asymptotic operators*

$$\mathbf{A}_{z_j}^\epsilon = \mathbf{A}_{z_j} \pm \epsilon_j$$

for $z_j \in \Gamma^\pm$.

Proof. Using the same trivialization as in (4.5.3), an easy computation shows

$$(\mathbf{L}^\epsilon v)(z)h = dv(z)h + i dv(z)jh + [C^\epsilon(z)v(z)]h \quad \text{for } h \in T_z \dot{\Sigma},$$

where

$$[C^\epsilon(z)v(z)]h := [C(z)v(z)]h - [d\gamma(z)h + i d\gamma(z)jh]v(z).$$

Choosing cylindrical coordinates $(s, t) \in Z^+$ near a positive puncture $z_j \in \Gamma^+$, we have $\partial_s \gamma(s, t) = \epsilon_j$ and $\partial_t \gamma(s, t) = 0$, so for $v \in \mathbb{C}$,

$$S^\epsilon(s, t)v := [C^\epsilon(s, t)v] \frac{\partial}{\partial s} = [C(s, t)v] \frac{\partial}{\partial s} - \epsilon_j v = [S(s, t) - \epsilon_j]v.$$

Thus $S_\infty^\epsilon(t) = S_\infty(t) - \epsilon_j$ and

$$\mathbf{A}_{z_j}^\epsilon = -J_0 \frac{d}{dt} - S_\infty^\epsilon(t) = \mathbf{A}_{z_j} + \epsilon_j.$$

At a negative puncture $z_j \in \Gamma^-$, there is a slightly subtle point: the asymptotic operator is related to \mathbf{L}^ϵ via coordinates (s, t) on the *negative* half-cylinder $Z^- = (-\infty, 0] \times S^1$, so we must reverse the sign of s and write $\gamma(s, t) = -\epsilon_j s$. Then the above calculation shows $\mathbf{A}_{z_j}^\epsilon = \mathbf{A}_{z_j} - \epsilon_j$. \square

As a consequence, we can assume that for generic choices of $\epsilon \in \mathbb{R}^N$, the asymptotic operators \mathbf{A}_z^ϵ are all nondegenerate in the sense defined in Sec. 4.2. This will imply that \mathbf{L}^ϵ is Fredholm, and its index will turn out to be uniquely defined if we confine the value of ϵ to a suitably small range.

To proceed further, we translate everything into the L^p -setting, where a wealth of previous results is available for operators of this type. We've used Hölder spaces up to this point because they are more convenient for the nonlinear problem. In particular, the definition of $\mathbf{F} : \mathcal{B} \rightarrow \mathcal{E}$ includes products of first derivatives, which would not make sense in $W^{1,p}$. But there is no problem in defining the *linear* operator,

$$\tilde{\mathbf{L}}^\epsilon : W_{\ell_\zeta}^{1,p}(E) \rightarrow L^p(F)$$

for $2 < p < \infty$, where $\tilde{\mathbf{L}}^\epsilon$ is identical to \mathbf{L}^ϵ on smooth sections.

Proposition 4.5.18. *If $\tilde{\mathbf{L}}^\epsilon$ is Fredholm, then so is \mathbf{L}^ϵ , and*

$$\ker \mathbf{L}^\epsilon = \ker \tilde{\mathbf{L}}^\epsilon \subset C_{\Gamma, \ell_\zeta}^{\infty, \delta}(E)$$

for sufficiently small positive weights $\delta = (\delta_1, \dots, \delta_N)$.

Proof. This follows from an argument given in [HWZ99], Sec. 2, using the standard Hölder theory for elliptic systems. In this case one needs both interior regularity [DN55] and regularity up to the boundary [ADN64]; see also [Wd79]. The exponential decay is derived by a standard argument for solutions of linear Cauchy-Riemann type equations on half-cylinders; see [HWZ96a]. \square

In light of this, we can alter our notation so that \mathbf{L}^ϵ is defined on $W_{\ell_\zeta}^{1,p}(E)$ for some $p \in (2, \infty)$. Note that $W_{\ell_\zeta}^{1,p}(E)$ is continuously embedded in $C_{b,\ell_\zeta}^0(E)$ by the Sobolev embedding theorem. One further simplification is possible: consider the restriction of \mathbf{L}^ϵ to an operator

$$\mathbf{L}_0^\epsilon : W_{\ell_\zeta}^{1,p}(E) \rightarrow L^p(F),$$

on the subspace $W_\ell^{1,p}(E) \subset W_{\ell_\zeta}^{1,p}(E)$ consisting of sections $v \in W^{1,p}(E)$ that satisfy the totally real boundary condition $v(\partial\Sigma) \subset \ell$. The restricted domain has codimension equal to m , the number of components of $\partial\Sigma$. To see this, choose for each component $\gamma_j \subset \partial\Sigma$ a smooth section $v_j : \dot{\Sigma} \rightarrow E$ with support in a neighborhood of γ_j , such that $v_j|_{\gamma_j} \equiv \zeta|_{\gamma_j}$. If $V \subset C_{\Gamma,\ell_\zeta}^{1+\alpha}(E)$ is the m -dimensional space spanned by these sections, then

$$W_{\ell_\zeta}^{1,p}(E) = V \oplus W_\ell^{1,p}(E).$$

Theorem 4.5.19. *Let $\sigma(\mathbf{A}_z) \subset \mathbb{R}$ denote the spectrum of \mathbf{A}_z , and define*

$$\sigma_{\mathbf{L}} = (\mp\sigma(\mathbf{A}_{z_1})) \times \dots \times (\mp\sigma(\mathbf{A}_{z_N})) \subset \mathbb{R}^N,$$

where the \mp signs are opposite the signs of the corresponding punctures. Then $\sigma_{\mathbf{L}}$ is a closed set of measure zero, and for any $\epsilon \in \mathbb{R}^N \setminus \sigma_{\mathbf{L}}$, the operator \mathbf{L}_0^ϵ is Fredholm. Moreover, the function

$$\mathbb{R}^N \setminus \sigma_{\mathbf{L}} \rightarrow \mathbb{Z} : \epsilon \mapsto \text{Ind } \mathbf{L}_0^\epsilon$$

is continuous.

Proof. Clearly $\sigma_{\mathbf{L}} \subset \mathbb{R}^N$ is a closed set of measure zero since $\sigma(\mathbf{A}_z) \subset \mathbb{R}$ is a discrete set for each z , and the condition $\epsilon \in \mathbb{R}^N \setminus \sigma_{\mathbf{L}}$ is satisfied if and only if all the operators $\mathbf{A}_{z_j}^\epsilon = \mathbf{A}_{z_j} \pm \epsilon_j$ for $z_j \in \Gamma^\pm$ are nondegenerate, i.e. $0 \notin \sigma(\mathbf{A}_{z_j}^\epsilon)$.

Under this nondegeneracy assumption, the Fredholm property was proved in [Sch96] for the case $\partial\Sigma = \emptyset$. The only extra ingredient needed for our situation is the boundary regularity estimate:

$$\|u\|_{W^{1,p}(\mathbb{D}^+)} \leq c \|\bar{\partial}u\|_{L^p(\mathbb{D}^+)}$$

for all smooth functions $u : \mathbb{D}^+ \rightarrow \mathbb{C}$ with compact support in $\mathbb{D}^+ \setminus (\mathbb{D}^+ \cap \partial\mathbb{D})$ and $u(\mathbb{D}^+ \cap \mathbb{R}) \subset \mathbb{R}$. With this addition, Schwarz's argument goes through as before, proving that \mathbf{L}_0^ϵ is Fredholm.

The continuity of the index follows because $\epsilon \mapsto \mathbf{L}_0^\epsilon$ defines a continuous path of Fredholm operators in any connected component of $\mathbb{R}^N \setminus \sigma_{\mathbf{L}}$. \square

In particular, we can assume \mathbf{L}_0^ϵ is Fredholm and has a uniquely defined index if all the weights ϵ_j are restricted to a sufficiently small interval $(0, c)$.

Corollary 4.5.20. $\mathbf{L} : C_{\Gamma, \ell_\zeta}^{1+\alpha, \epsilon}(E) \oplus Y_0 \rightarrow C_{\Gamma}^{\alpha, \epsilon}(F)$ is Fredholm for any $\epsilon \in \mathbb{R}^N \setminus \sigma_{\mathbf{L}}$, and if $\partial\Sigma$ has m connected components, $\text{Ind } \mathbf{L} = \text{Ind } \mathbf{L}_0^\epsilon + m + \dim Y_0$.

Corollary 4.5.21. For $\tilde{u} \in \mathcal{M}(\hat{J}, L)$, the linearization $\mathbf{L}_{\tilde{u}}$ is Fredholm, and so is the restriction $\mathbf{L}_{\tilde{u}, z}$ for any Morse-Bott puncture $z \in \Gamma$, with $\text{Ind } \mathbf{L}_{\tilde{u}, z} = \text{Ind } \mathbf{L}_{\tilde{u}} - 1$.

When all the weights ϵ_j are nonnegative and small (as is the case for the operators $\mathbf{L}_{\tilde{u}}$ and $\mathbf{L}_{\tilde{u}, z}$), it is useful to relate $\mathbf{L} : C_{\Gamma, \ell_\zeta}^{1+\alpha, \epsilon}(E) \oplus Y_0 \rightarrow C_{\Gamma}^{\alpha, \epsilon}(F)$ to an operator defined on sections that *grow* exponentially at some punctures. Recall that the p -dimensional space $Y_0 = Y^{z_1} \oplus \dots \oplus Y^{z_p}$ includes a factor for each puncture z_j in some subset of Γ , where by assumption each of the asymptotic operators $\mathbf{A}_{z_1}, \dots, \mathbf{A}_{z_p}$ has a one-dimensional kernel. It follows that if $\epsilon = (\epsilon_1, \dots, \epsilon_N) \in \mathbb{R}^N \setminus \sigma_{\mathbf{L}}$, ϵ_j can't be 0 for $j \in \{1, \dots, p\}$; let us therefore assume these weights are positive. Now set

$$\epsilon' = (-\epsilon_1, \dots, -\epsilon_p, \epsilon_{p+1}, \dots, \epsilon_N) \in \mathbb{R}^N,$$

and observe that there is a continuous inclusion

$$C_{\Gamma, \ell_\zeta}^{1+\alpha, \epsilon}(E) \oplus Y_0 \hookrightarrow C_{\Gamma, \ell_\zeta}^{1+\alpha, \epsilon'}(E).$$

We can extend \mathbf{L} to the larger space, defining a new operator

$$\mathbf{L}_+ : C_{\Gamma, \ell_\zeta}^{1+\alpha, \epsilon'}(E) \rightarrow C_{\Gamma}^{\alpha, \epsilon'}(F).$$

This operator is Fredholm by Corollary 4.5.20 if ϵ is sufficiently close to 0.

Proposition 4.5.22. If $\epsilon = (\epsilon_1, \dots, \epsilon_N) \in \mathbb{R}^N \setminus \sigma_{\mathbf{L}}$ with each $\epsilon_j \geq 0$ sufficiently small, then $\text{Ind } \mathbf{L} = \text{Ind } \mathbf{L}_+$, and $\ker \mathbf{L} \subset \ker \mathbf{L}_+$.

Proof. The second statement is obvious. To see that the indices are equal, consider the operators

$$\begin{aligned} \mathbf{L}^\epsilon &= \mathbf{W}^\epsilon \mathbf{L}' \mathbf{W}^{-\epsilon} : C_{\Gamma, \ell_\zeta}^{1+\alpha}(E) \rightarrow C_{\Gamma}^\alpha(F), \\ \mathbf{L}_+^{\epsilon'} &= \mathbf{W}^{\epsilon'} \mathbf{L}_+ \mathbf{W}^{-\epsilon'} : C_{\Gamma, \ell_\zeta}^{1+\alpha}(E) \rightarrow C_{\Gamma}^\alpha(F), \end{aligned}$$

where \mathbf{L}' is the restriction of \mathbf{L} to $C_{\Gamma, \ell_\zeta}^{1+\alpha, \epsilon}(E) \subset C_{\Gamma, \ell_\zeta}^{1+\alpha, \epsilon}(E) \oplus Y_0$. Both can equally well be regarded as linear maps $W_{\ell_\zeta}^{1,p}(E) \rightarrow L^p(F)$ for $p \in (2, \infty)$, and it suffices to prove

$$\text{Ind } \mathbf{L}_+^{\epsilon'} = \text{Ind } \mathbf{L}^\epsilon + \dim Y_0.$$

This will follow from the index formula presented in the next section, though we can give another justification here, using the linear gluing operation of M. Schwarz

[Sch96]. We observe first that the asymptotic operators $\mathbf{A}_{z_j}^\epsilon$ for \mathbf{L}^ϵ and $\mathbf{A}_{z_j,+}^{\epsilon'}$ for $\mathbf{L}_+^{\epsilon'}$ are related by

$$\begin{aligned} \mathbf{A}_{z_j}^\epsilon &= \mathbf{A}_{x_j} \pm \epsilon_j, & \mathbf{A}_{z_j,+}^{\epsilon'} &= \mathbf{A}_{x_j} \mp \epsilon_j & \text{for } j \in \{1, \dots, p\}, \\ \mathbf{A}_{z_j}^\epsilon &= \mathbf{A}_{x_j} \pm \epsilon_j = \mathbf{A}_{z_j,+}^{\epsilon'} & & & \text{for } j \in \{p+1, \dots, N\}, \end{aligned}$$

where $x_j : S^1 \rightarrow M_\pm$ parametrize the asymptotic limits at $z_j \in \Gamma^\pm$. Then $\mathbf{L}_+^{\epsilon'}$ has the same index as an operator constructed from \mathbf{L}^ϵ by a gluing operation as follows: attach to the cylindrical end at each puncture $z_j \in \Gamma^\pm$ a cylinder $\mathbb{R} \times S^1$, with a Cauchy-Riemann operator \mathbf{L}_j whose asymptotic operators are $\mathbf{A}_{z_j}^\epsilon$ at the end glued to $\dot{\Sigma}$, and $\mathbf{A}_{z_j,+}^{\epsilon'}$ at the other end. Symbolically, we have

$$(\dot{\Sigma}, \mathbf{L}_+^{\epsilon'}) \cong (\dot{\Sigma}, \mathbf{L}^\epsilon) \# \bigsqcup_{j=1}^N (\mathbb{R} \times S^1, \mathbf{L}_j),$$

and by the additivity of the index,

$$\text{Ind } \mathbf{L}_+^{\epsilon'} = \text{Ind } \mathbf{L}^\epsilon + \sum_{j=1}^N \text{Ind } \mathbf{L}_j.$$

The indices \mathbf{L}_j are determined as in Floer homology by spectral flow: this gives 0 for $j \in \{p+1, \dots, N\}$ since in these cases the asymptotic operators match at either end. For $j \in \{1, \dots, p\}$, \mathbf{A}_{x_j} has 0 as an eigenvalue of multiplicity 1, and this determines the spectral flow between $\mathbf{A}_{z_j}^\epsilon$ and $\mathbf{A}_{z_j,+}^{\epsilon'}$ if ϵ_j is sufficiently small. Thus $\text{Ind } \mathbf{L}_j = 1$, and we see that $\text{Ind } \mathbf{L}_{\bar{u},+}^{-\epsilon} - \text{Ind } \mathbf{L}_{\bar{u}}^\epsilon = p = \dim Y_0$. \square

The result is useful for two reasons: first, we'll see in the next section that the index of \mathbf{L}_+ can be expressed nicely in terms of a generalized Maslov index. We will also find in Sec. 4.5.5 some simple criteria for proving that \mathbf{L}_+ is surjective, which then immediately implies the surjectivity of \mathbf{L} .

4.5.4 Index formula

Assume $\partial\Sigma$ has $m \geq 0$ connected components, and consider an admissible Cauchy-Riemann type operator

$$\mathbf{L} : W_{\ell_\zeta}^{1,p}(E) \rightarrow L^p(F)$$

along with its restriction

$$\mathbf{L}_0 : W_\ell^{1,p}(E) \rightarrow L^p(F),$$

where $2 < p < \infty$. Assume that all the asymptotic operators \mathbf{A}_z are nondegenerate. Then both operators are Fredholm by Theorem 4.5.19, and $\text{Ind } \mathbf{L} = \text{Ind } \mathbf{L}_0 + m$. We shall concern ourselves in this section with computing $\text{Ind } \mathbf{L}_0$. As a consequence we obtain a formula for the index of the linearization $\mathbf{L}_{\tilde{u}}$.

If $\dot{\Sigma}$ were a closed Riemann surface, the index of \mathbf{L}_0 would be derived from the Riemann-Roch formula. Index formulas for compact manifolds with boundary can be reduced to this case by gluing arguments, see for instance [MS04]. In his thesis, M. Schwarz [Sch96] developed a gluing procedure that accomplishes the same thing for manifolds with cylindrical ends and nondegenerate asymptotic data. Observe that when $\dot{\Sigma}$ is not compact, the zeroth order term Cv is not a compact perturbation; its asymptotic behavior is crucial in determining the Fredholm index.

For the mixed boundary value problem, the Maslov index at the boundary must also play a role. An integer that naturally arises in this situation is the *generalized normal Maslov index* $\mu_N(\tilde{u})$. It is computed according to a prescription similar to $\mu(\tilde{u})$, but using the normal bundle $\nu\tilde{u} \rightarrow \bar{\Sigma}$ instead of the bundle of contact planes $\tilde{u}^*\xi \rightarrow \bar{\Sigma}$ (the latter is not globally defined for Problem **(BP')**). Recall that for any solution $\tilde{u} \in \mathcal{M}(\hat{J}, L)$, the extension of $\nu\tilde{u} \rightarrow \dot{\Sigma}$ to an asymptotically trivial complex line bundle over the circle compactification $\bar{\Sigma}$ satisfies

$$(\nu\tilde{u})|_{\delta_z} = x^*\xi_{\pm}$$

for some parametrization $x : \delta_z \rightarrow M_{\pm}$ of the asymptotic limit at $z \in \Gamma^{\pm}$. Thus the asymptotic operator $\mathbf{A}_x : H^1(x^*\xi_{\pm}) \rightarrow L^2(x^*\xi_{\pm})$ furnishes boundary data at δ_z for the bundle $\nu\tilde{u} \rightarrow \bar{\Sigma}$. For boundary data at $\partial\Sigma$, we recall that the normal bundle was defined so that there is always a one-dimensional intersection

$$(\ell_N)_z = (\nu\tilde{u})_z \cap T_{\tilde{u}(z)}L_0,$$

where L_0 is the surface defining the totally real boundary condition for \tilde{u} . Thus ℓ_N is a totally real subbundle of $\nu\tilde{u}$ over $\partial\Sigma$, and we can use this together with the asymptotic operators described above to define boundary data \mathcal{B}_N for $\nu\tilde{u}$. The normal Maslov index is then defined by

$$\mu_N(\tilde{u}) = \mu(\nu\tilde{u}, \mathcal{B}_N).$$

There is a similar index associated to the Fredholm operators \mathbf{L} and \mathbf{L}_0 . Both are defined on a space of sections of a trivial bundle $E \rightarrow \dot{\Sigma}$, satisfying a boundary condition determined by a totally real subbundle $\ell \subset E|_{\partial\Sigma}$. The asymptotic behavior of the zeroth order term defines the asymptotic operators $\mathbf{A}_z : H^1(E|_{\delta_z}) \rightarrow L^2(E|_{\delta_z})$, which together with ℓ furnish boundary data $\mathcal{B}_{\mathbf{L}} = \mathcal{B}_{\mathbf{L}_0}$ for $E \rightarrow \bar{\Sigma}$. This is closely

related to the normal Maslov index, in that if $\tilde{u} \in \mathcal{M}(\hat{J}, L)$ has nondegenerate asymptotic limits, clearly

$$\mu_N(\tilde{u}) = \mu(E, \mathcal{B}_{\mathbf{L}_{\tilde{u}}}).$$

This extends to the case of Morse-Bott asymptotic limits: recall that $\mu_N(\tilde{u}) = \mu(\nu\tilde{u}, \mathcal{B}_N)$ is then defined in terms of the perturbed asymptotic operators $\mathbf{A}_x^\mp = \mathbf{A}_x \mp \epsilon$ for $z \in \Gamma^\pm$ with small $\epsilon > 0$, and $\mu(E, \mathcal{B}_{\mathbf{L}_{\tilde{u}}})$ can be defined similarly. By Prop. 4.5.22, $\mathbf{L}_{\tilde{u}}$ has the same Fredholm index as the corresponding operator on a Hölder space with exponential growth at the degenerate punctures,

$$\mathbf{L}_{\tilde{u},+} : C_{\Gamma, \ell_\zeta}^{1+\alpha, \epsilon'}(E) \rightarrow C_{\Gamma}^{\alpha, \epsilon'}(F).$$

This in turn is equivalent to an operator $\mathbf{L}_{\tilde{u},+}^{\epsilon'} : W_{\ell_\zeta}^{1,p}(E) \rightarrow L^p(F)$ with nondegenerate asymptotic operators $\mathbf{A}_{z,+}^{\epsilon'} = \mathbf{A}_z \mp \epsilon$, at each degenerate puncture $z \in \Gamma^\pm$, hence

$$\mu_N(\tilde{u}) = \mu(E, \mathcal{B}_{\mathbf{L}_{\tilde{u}}}) = \mu(E, \mathcal{B}_{\mathbf{L}_{\tilde{u},+}^{\epsilon'}}).$$

It is therefore possible to restrict our attention to operators with nondegenerate asymptotics and find a formula for $\text{Ind } \mathbf{L}_{\tilde{u},+}^{\epsilon'} = \text{Ind } \mathbf{L}_{\tilde{u}}$ in terms of $\mu(E, \mathcal{B}_{\mathbf{L}_{\tilde{u},+}^{\epsilon'}}) = \mu_N(\tilde{u})$.

We return now to the operator $\mathbf{L}_0 : W_{\ell}^{1,p}(E) \rightarrow L^p(F)$. Recalling that $\mu(E, \mathcal{B})$ was previously defined in the case of a closed surface to be twice the first Chern number of E , the following index formula should come as no surprise—it is a direct generalization of Riemann-Roch for rank 1 bundles.

Theorem 4.5.23. $\text{Ind } \mathbf{L}_0 = \mu(E, \mathcal{B}_{\mathbf{L}}) + \chi(\dot{\Sigma})$

Proof. For $\partial\Sigma = \emptyset$, this is a special case of the formula of Schwarz [Sch96], proved by gluing Fredholm operators along cylindrical ends with opposite signs. We can reduce our situation to this case by doubling Σ along the boundary. Recall from Sec. 4.2 that there are natural conjugate bundles $E^c \rightarrow \bar{\Sigma}^c$ and $F^c \rightarrow \bar{\Sigma}^c$, where $\dot{\Sigma}^c = \Sigma^c \setminus \Gamma^c$ has the same punctures as $\dot{\Sigma}$ but with opposite signs. The natural antilinear bundle isomorphisms $E \rightarrow E^c$ and $F \rightarrow F^c$ then define a conjugate Fredholm operator

$$\mathbf{L}_0^c : W_{\ell^c}^{1,p}(E^c) \rightarrow L^p(F^c),$$

with $\text{Ind } \mathbf{L}_0^c = \text{Ind } \mathbf{L}_0$. These two operators can now be glued along the boundary by the construction described in [MS04], Appendix C, forming a doubled operator

$$\mathbf{L}_0^D : W^{1,p}(E^D) \rightarrow L^p(F^D).$$

Here E^D and F^D are bundles over a surface Σ^D with cylindrical ends and no boundary. The Fredholm index is additive with respect to the gluing operation, so combining this with the formula of Schwarz and using Prop. 4.2.8 to compute the Maslov index on E^D ,

$$\begin{aligned} 2 \operatorname{Ind} \mathbf{L}_0 &= \operatorname{Ind} \mathbf{L}_0 + \operatorname{Ind} \mathbf{L}_0^c = \operatorname{Ind} \mathbf{L}_0^D \\ &= \mu(E^D, \mathcal{B}_{\mathbf{L}^D}) + \chi(\dot{\Sigma}^D) = 2\mu(E, \mathcal{B}_{\mathbf{L}}) + 2\chi(\dot{\Sigma}). \end{aligned}$$

□

For a solution $\tilde{u} \in \mathcal{M}(\hat{J}, L)$, we use from now on the notation

$$\operatorname{Ind}(\tilde{u}) := \operatorname{Ind} \mathbf{L}_{\tilde{u}}.$$

This is uniquely defined, given any generic choice of small exponential weights $\epsilon_j \geq 0$ for the domain $C_{\Gamma, \ell_\zeta}^{1+\alpha, \epsilon}(E) \oplus Y_0$.

Corollary 4.5.24. *For any solution $\tilde{u} : \Sigma \setminus \Gamma \rightarrow W$ of Problem (BP'),*

$$\boxed{\operatorname{Ind}(\tilde{u}) = \mu_N(\tilde{u}) + \chi(\dot{\Sigma}) + m = \mu_N(\tilde{u}) + 2 - 2g - \#\Gamma}$$

where g is the genus of Σ and m is the number of boundary components.

Proof. This follows immediately from Theorem 4.5.23 and Lemma 4.5.16, together with the discussion of the normal Maslov index above. □

Notice that if the genus and punctures are fixed, then the index formula has no dependence on the number of boundary components m (except implicitly in the Maslov index). This is one of the main features that makes the theory useful for surgery: one can cut out disks virtually at will without compromising the nice properties of the solutions. We shall see this phenomenon again in the discussion of transversality below, as well as in the actual surgery construction (cf. Remark 5.1.11).

We now put the index formula in a more useful form for Problem (BP). Assume $(W, \hat{J}) = (\mathbb{R} \times M, \tilde{J})$, and the totally real submanifolds consist of families of graphs $\tilde{L}_j^\sigma \subset \mathbb{R} \times M$ covering embedded surfaces $L_j \subset M$ that are tangent to X_λ .

Lemma 4.5.25. *For any immersed solution $\tilde{u} : \dot{\Sigma} \rightarrow \mathbb{R} \times M$ of (BP),*

$$\mu(\tilde{u}) = \mu_N(\tilde{u}) + 2\chi(\dot{\Sigma}).$$

Proof. Extend \tilde{u} to a continuous map $\bar{u} : \bar{\Sigma} \rightarrow \bar{\mathbb{R}} \times M$, where $\bar{\mathbb{R}} = [-\infty, \infty]$. The tangent bundle $T(\mathbb{R} \times M)$ has a natural extension to a continuous rank 2 complex vector bundle

$$\overline{T(\mathbb{R} \times M)} \rightarrow \bar{\mathbb{R}} \times M,$$

and the pull-back $\bar{u}^* \overline{T(\mathbb{R} \times M)} \rightarrow \bar{\Sigma}$ then contains both $\bar{u}^* \xi \rightarrow \bar{\Sigma}$ and $\nu \tilde{u} \rightarrow \bar{\Sigma}$ as complex subbundles. By definition, $\mu(\tilde{u}) = \mu(\bar{u}^* \xi, \mathcal{B})$ where the boundary data \mathcal{B} consist of the totally real subbundle

$$\ell = \tilde{u}^* \xi \cap \tilde{u}^* TL \rightarrow \partial \Sigma,$$

and the asymptotic operators $\mathbf{A}_z : H^1(x^* \xi) \rightarrow L^2(x^* \xi)$ corresponding to the parametrized asymptotic limit $x : \delta_z \rightarrow M$ at each puncture $z \in \Gamma$. Similarly, $\mu_N(\tilde{u}) = \mu(\nu \tilde{u}, \mathcal{B}_N)$ where \mathcal{B}_N has the same asymptotic operators \mathbf{A}_z at $\nu \tilde{u}|_{\delta_z} = x^* \xi = \bar{u}^* \xi|_{\delta_z}$, and the totally real subbundle

$$\ell_N = \nu \tilde{u} \cap \tilde{u}^* T\tilde{L} \rightarrow \partial \Sigma.$$

Here $L \subset M$ is a surface tangent to X_λ and $\tilde{L} \subset \mathbb{R} \times L \subset \mathbb{R} \times M$ is a graph of some real-valued function on L . Define now a trivial complex subbundle,

$$\eta = \mathbb{R} \oplus \mathbb{R}X_\lambda \subset \overline{T(\mathbb{R} \times M)} \rightarrow \bar{\mathbb{R}} \times M,$$

which pulls back continuously to a complex line bundle $\bar{u}^* \eta \rightarrow \bar{\Sigma}$. We endow $\bar{u}^* \eta$ with boundary data \mathcal{B}_1 , consisting of the totally real subbundle

$$\ell_1 = \mathbb{R}X_\lambda \rightarrow \partial \Sigma,$$

and any nondegenerate asymptotic operators \mathbf{B}_z such that $\mu_{CZ}(\mathbf{B}_z) = 0$ with respect to the natural trivialization. Finally, observe that the complex subbundle $\tilde{u}_* T\dot{\Sigma} \subset \tilde{u}^* T(\mathbb{R} \times M) \rightarrow \dot{\Sigma}$ with fibers

$$(\tilde{u}_* T\dot{\Sigma})_z = \text{im } d\tilde{u}(z) \subset T_{\tilde{u}(z)}(\mathbb{R} \times M)$$

also extends to a continuous complex line bundle $\tilde{u}_* T\bar{\Sigma} \rightarrow \bar{\Sigma}$ with $\tilde{u}_* T\bar{\Sigma}|_{\delta_z} = \bar{u}^* \eta|_{\delta_z}$. A natural choice of boundary data \mathcal{B}_2 for $\tilde{u}_* T\bar{\Sigma}$ is defined by the real subbundle

$$\ell_2 = \tilde{u}_* T(\partial \Sigma) \rightarrow \partial \Sigma,$$

along with the same asymptotic operators \mathbf{B}_z that were chosen for $\bar{u}^* \eta$.

Putting these line bundles together in direct sums, we have

$$\bar{u}^* \xi \oplus \bar{u}^* \eta = \bar{u}^* \overline{T(\mathbb{R} \times M)} = \nu \tilde{u} \oplus \tilde{u}_* T\bar{\Sigma}.$$

Moreover, the two sets of boundary data $\mathcal{B} \oplus \mathcal{B}_1$ and $\mathcal{B}_N \oplus \mathcal{B}_2$ have identical asymptotic operators $\mathbf{A}_z \oplus \mathbf{B}_z$, and homotopic totally real subbundles

$$\ell \oplus \ell_1 = \tilde{u}^*TL \rightarrow \partial\Sigma \quad \text{and} \quad \ell_N \oplus \ell_2 = \tilde{u}^*T\tilde{L} \rightarrow \partial\Sigma.$$

Thus by Prop. 4.2.3,

$$\mu(\bar{u}^*\xi, \mathcal{B}) + \mu(\bar{u}^*\eta, \mathcal{B}_1) = \mu(\bar{u}^*\overline{T(\mathbb{R} \times M)}, \mathcal{B} \oplus \mathcal{B}_1) = \mu(\nu\tilde{u}, \mathcal{B}_N) + \mu(\overline{\tilde{u}_*T\Sigma}, \mathcal{B}_2). \quad (4.5.4)$$

The bundle $\bar{u}^*\eta$ is trivial and has trivial boundary data, so clearly $\mu(\bar{u}^*\eta, \mathcal{B}_1) = 0$. To compute $\mu(\overline{\tilde{u}_*T\Sigma}, \mathcal{B}_2)$, choose first a generic vector field $Y \in \text{Vec}(\dot{\Sigma})$ which has only interior zeros, is tangent to $\partial\Sigma$ and equals $\frac{\partial}{\partial s}$ in cylindrical coordinates $(s, t) \in Z^+$ near each puncture. This extends continuously to a section of $\overline{T\Sigma} \rightarrow \overline{\Sigma}$ and thus defines a complex trivialization of $\overline{\tilde{u}_*T\Sigma} \rightarrow \overline{\Sigma}$ near the boundary and punctures; in this trivialization all Maslov and Conley-Zehnder indices for \mathcal{B}_2 vanish. The algebraic number of zeros of Y is $\chi(\dot{\Sigma})$, which is therefore also the winding number $\text{wind}_{\partial\overline{\Sigma}}(Y)$ with respect to any global trivialization of $\overline{T\Sigma}$, so we conclude $\mu(\overline{\tilde{u}_*T\Sigma}, \mathcal{B}_2) = 2\chi(\dot{\Sigma})$. The result now follows from (4.5.4). \square

Let us apply this relation and summarize the most important results of this section.

Theorem 4.5.26. *Let $\tilde{u} : \dot{\Sigma} \rightarrow \mathbb{R} \times M$ be an embedded solution of (BP), defined on a Riemann surface with genus g , m boundary components, and interior punctures $\Gamma \subset \text{int } \Sigma$. Then the linearized Cauchy-Riemann operator $\mathbf{L}_{\tilde{u}}$ is Fredholm for some suitable choice of exponential weights, and its index is*

$$\boxed{\text{Ind}(\tilde{u}) = \mu(\tilde{u}) - \chi(\dot{\Sigma}) + m = \mu(\tilde{u}) + 2(g + m - 1) + \#\Gamma.} \quad (4.5.5)$$

4.5.5 Automatic transversality results

It is a peculiarly four-dimensional phenomenon in the study of pseudoholomorphic curves, that one can sometimes prove transversality for the linearized Cauchy-Riemann operator without having to assume that \hat{J} is generic. Such results can usually be stated in the form “ \mathbf{L} is always surjective if its Fredholm index is large enough”.

Example 4.5.27. *Suppose (W, J) is an almost complex 4-manifold, (Σ, j) is a compact Riemann surface with genus g and m boundary components, and $u : \Sigma \rightarrow W$ is an immersed J -holomorphic curve satisfying a standard totally real boundary condition. Then a result of Hofer, Lizan and Sikorav [HLS97] shows that the linearized operator for this problem is surjective whenever $\text{Ind}(u) \geq 2g + m - 1$. Another presentation of this result may be found in [MS04], Appendix C.*

In this section we prove some analogous results for the linearization $\mathbf{L}_{\tilde{u}}$ of $\tilde{u} \in \mathcal{M}(\hat{J}, L)$. Note that since \tilde{u} may have degenerate asymptotics, it's more convenient to consider the operator

$$\mathbf{L}_{\tilde{u},+}^{\epsilon'} : W_{\ell_\zeta}^{1,p}(E) \rightarrow L^p(F)$$

for $2 < p < \infty$; this has the same Fredholm index and Maslov index as $\mathbf{L}_{\tilde{u}}$, and is conjugate to an operator $\mathbf{L}_{\tilde{u},+} : C_{\Gamma, \ell_\zeta}^{1+\alpha, \epsilon'}(E) \rightarrow C_{\Gamma}^{\alpha, \epsilon'}(F)$ whose kernel contains $\ker \mathbf{L}_{\tilde{u}}$. Thus it suffices to prove that $\mathbf{L}_{\tilde{u},+}^{\epsilon'}$ is surjective, and any statement made about sections in its kernel will also apply to the kernel of $\mathbf{L}_{\tilde{u}}$.

Assume $2 < p < \infty$ and let $\mathbf{L} : W_{\ell_\zeta}^{1,p}(E) \rightarrow L^p(F)$ be an admissible Cauchy-Riemann type operator with nondegenerate asymptotic operators \mathbf{A}_z ; denote by \mathbf{L}_0 its restriction to the subspace $W_{\ell}^{1,p}(E)$, which has codimension m . Both operators are Fredholm, with $\text{Ind } \mathbf{L}_0$ given by Theorem 4.5.23, and $\text{Ind } \mathbf{L} = \text{Ind } \mathbf{L}_0 + m$. The first step toward proving surjectivity for \mathbf{L} is to estimate the number of zeros for any section in $\ker \mathbf{L}$. This will be very similar to the discussion of $\text{wind}_\pi(\tilde{u})$ in Sec. 4.3. To begin with, we can apply the similarity principle (Prop. 4.3.4) to sections $v \in \ker \mathbf{L}$.

Lemma 4.5.28. *If $v \in W_{\ell_\zeta}^{1,p}(E)$ satisfies $\mathbf{L}v \equiv 0$ and v is not identically zero, then all zeros of v are isolated and have positive order.*

Proof. If $z \in \dot{\Sigma}$ and $v(z) = 0$, one can choose coordinates $s + it \in \mathbb{D}$ or \mathbb{D}^+ near z and local trivializations of E and F in which $\mathbf{L}v = 0$ translates to an equation of the form

$$\partial_s v + i\partial_t v + Av = 0.$$

The similarity principle immediately applies if $z \in \text{int } \dot{\Sigma}$ proving that z is an isolated zero with positive order. If $z \in \partial\Sigma$, let $\gamma \subset \partial\Sigma$ denote the connected component containing z . The boundary condition requires $v(\gamma) \subset \ell + \tau\zeta$ for some $\tau \in \mathbb{R}$, and τ must be 0 since $\zeta(z) \in E_z \setminus \ell_z$. Thus $v(\gamma) \subset \ell$, and we can choose the trivializations so that ℓ is identified with $\mathbb{R} \subset \mathbb{C}$. The result then follows from the boundary version of the similarity principle. \square

We recall some notation from Sec. 4.3: the zero set of a section $v : \dot{\Sigma} \rightarrow E$ is denoted by $Z(v) \subset \dot{\Sigma}$, and in the case where $Z(v)$ is finite, the algebraic count is defined by weighting interior zeros twice as heavily as boundary zeros:

$$N(v) = \sum_{z \in Z(v) \cap \text{int } \dot{\Sigma}} o(z) + \frac{1}{2} \sum_{z \in Z(v) \cap \partial\Sigma} o(z).$$

Note that this may in general be a half-integer. We then have the following analog of Theorem 4.3.7.

Theorem 4.5.29. *Let $v : \dot{\Sigma} \rightarrow E$ be a section in $\ker \mathbf{L}$ which is not identically zero. Then v has finitely many zeros, and $0 \leq 2N(v) \leq \mu(E, \mathcal{B}_{\mathbf{L}}) - \#\Gamma_1$.*

Proof. The reader may want to consult the proof of Theorem 4.3.7 for reference, as many of the calculations here are the same. We can choose a global trivialization of E and identify sections with functions $v : \dot{\Sigma} \rightarrow \mathbb{C}$. Then arguing as in [HWZ96a], one finds that a function v satisfying $dv + i dv \circ j + Cv \equiv 0$ has its behavior near any puncture $z \in \Gamma^\pm$ determined by some eigenfunction of the self-adjoint asymptotic operator $\mathbf{A}_z : H^1(E|_{\delta_z}) \rightarrow L^2(E|_{\delta_z})$. The winding numbers of these eigenfunctions can be related to the Conley-Zehnder index $\mu_{\text{CZ}}(\mathbf{A}_z) = 2\alpha(z) + p(z)$: specifically $\text{wind}_{\delta_z}(v) \leq \alpha(z)$ for $z \in \Gamma^+$, while for $z \in \Gamma^-$, $\text{wind}_{\delta_z}(v) \geq \alpha(z) + p(z)$.

At a component $\gamma_j \subset \partial\Sigma$ we have $v(z) \in \ell_z + \tau_j \zeta(z)$ for all $z \in \gamma_j$. If $\tau_j \neq 0$, then $v(z)$ is never zero on γ_j , and $\text{wind}_{\gamma_j}(v) = \text{wind}_{\gamma_j}(\zeta)$ equals the winding number of any nonzero section of ℓ along γ_j . Thus $2 \text{wind}_{\gamma_j}(v) = \mu(E|_{\gamma_j}, \ell|_{\gamma_j})$. (Recall that ℓ is orientable on each component, so all Maslov indices are even.) On the other hand, if $\tau_j = 0$, then v satisfies a standard totally real boundary condition on γ_j and we can relate the number of boundary zeros to $\mu(E|_{\gamma_j}, \ell|_{\gamma_j})$. Let us partition $\partial\bar{\Sigma} = \partial_0\bar{\Sigma} \cup \partial_1\bar{\Sigma}$ by setting

$$\begin{aligned} \partial_0\bar{\Sigma} &= \bigcup_{\tau_j=0} \gamma_j \\ \partial_1\bar{\Sigma} &= \left(\bigcup_{\tau_j \neq 0} \gamma_j \right) \cup \left(\bigcup_{z \in \Gamma^+} \delta_z \right) \cup \left(\bigcup_{z \in \Gamma^-} -\delta_z \right) \end{aligned}$$

Now, using terminology from Sec. 4.3, v is an *admissible* section in the sense that it is nonzero on $\partial_1\bar{\Sigma}$ and satisfies a totally real boundary condition $v(\partial_0\bar{\Sigma}) \subset \ell|_{\partial_0\bar{\Sigma}}$. Applying Prop. 4.3.2,

$$\begin{aligned} 2N(v) &= 2 \text{wind}_{\partial_1\bar{\Sigma}}(v) + \mu(E|_{\partial_0\bar{\Sigma}}, \ell|_{\partial_0\bar{\Sigma}}) \\ &= 2 \sum_{z \in \Gamma^+} \text{wind}_{\delta_z}(v) - 2 \sum_{z \in \Gamma^-} \text{wind}_{\delta_z}(v) + 2 \sum_{\tau_j \neq 0} \text{wind}_{\gamma_j}(v) + \mu(E|_{\partial_0\bar{\Sigma}}, \ell|_{\partial_0\bar{\Sigma}}) \\ &\leq 2 \sum_{z \in \Gamma^+} \alpha(z) - 2 \sum_{z \in \Gamma_0^-} \alpha(z) - 2 \sum_{z \in \Gamma_1^-} (\alpha(z) + 1) + \sum_{\tau_j \neq 0} \mu(E|_{\gamma_j}, \ell|_{\gamma_j}) + \mu(E|_{\partial_0\bar{\Sigma}}, \ell|_{\partial_0\bar{\Sigma}}) \\ &= \sum_{z \in \Gamma^+} (2\alpha(z) + p(z)) - \#\Gamma_1^+ - \sum_{z \in \Gamma^-} (2\alpha(z) + p(z)) - \#\Gamma_1^- + \mu(E, \ell) \\ &= \mu(E, \mathcal{B}_{\mathbf{L}}) - \#\Gamma_1. \end{aligned}$$

□

As we will see, a consequence of this inequality is that there are two things capable of preventing an operator \mathbf{L} with positive Fredholm index from being surjective: large genus, and an abundance of even punctures. If both of these conditions are absent, which is the case we're most interested in, the situation is quite favorable. The following transversality result will be superseded later by Theorem 4.5.36, but it's an important enough special case to single out, and the statement about zeros in the index 2 case is useful in itself.

Theorem 4.5.30. *Suppose Σ has genus 0 and all punctures in Γ are odd. Then if $\text{Ind } \mathbf{L} \geq 2$, \mathbf{L} is surjective. In particular, for the case where $\text{Ind } \mathbf{L} = 2$, all sections in $\ker \mathbf{L}$ are zero free.*

Proof. Note first that the Fredholm index $\text{Ind } \mathbf{L} = \mu(E, \mathcal{B}_{\mathbf{L}}) + \chi(\dot{\Sigma}) + m = \mu(E, \mathcal{B}_{\mathbf{L}}) + 2 - 2g - \#\Gamma = \mu(E, \mathcal{B}_{\mathbf{L}}) + 2 - \#\Gamma_1$ is necessarily even in this case, as $\mu(E, \mathcal{B}_{\mathbf{L}})$ and $\#\Gamma_1$ always have the same parity. Thus denote $2p = \text{Ind } \mathbf{L}$. Combining the index formula with Theorem 4.5.29, we have

$$2 \sum_{z \in Z(v) \cap \text{int } \dot{\Sigma}} o(z) + \sum_{z \in Z(v) \cap \partial \Sigma} o(z) \leq \mu(E, \mathcal{B}_{\mathbf{L}}) - \#\Gamma_1 = 2p - 2. \quad (4.5.6)$$

Now pick a global trivialization of E along with p distinct points $z_1, \dots, z_p \in \text{int } \dot{\Sigma}$, and define a linear evaluation map

$$A : \ker \mathbf{L} \rightarrow \mathbb{C}^p : v \mapsto (v(z_1), \dots, v(z_p)).$$

This map is injective, since if $A(v) = 0$ and $v \neq 0$, it means $v \in \ker \mathbf{L}$ is a nonzero section with at least p distinct interior zeros, all of which are positive, so

$$2 \sum_{z \in Z(v) \cap \text{int } \dot{\Sigma}} o(z) \geq 2p,$$

in contradiction to (4.5.6). Therefore $\dim \ker \mathbf{L} \leq 2p = \text{Ind } \mathbf{L}$, which implies that the cokernel of \mathbf{L} is trivial.

The statement about the index 2 case follows immediately from (4.5.6). \square

Remark 4.5.31. *Though we have assumed nondegenerate asymptotics for \mathbf{L} , Theorem 4.5.30 applies just as well to $\mathbf{L}_{\tilde{a}}$ when the asymptotic limits are Morse-Bott. Recall that each puncture has a well defined parity defined by the perturbed asymptotic operator $\mathbf{A}_z^{\mp} = \mathbf{A}_z \mp \epsilon$, and one sees easily that this matches the parity defined by the asymptotic operators of $\mathbf{L}_{\tilde{a},+}^{\epsilon'}$.*

The inequality in Theorem 4.5.29 also provides a means of proving that \mathbf{L} is *injective*, since any section v in the kernel also has an *a priori* lower bound $N(v) \geq 0$. This observation is not immediately useful for the implicit function theorem, but it becomes much more so when applied to the *formal adjoint* of \mathbf{L} .

Choose a metric g on $\dot{\Sigma}$ compatible with the complex structure j , such that $g = ds^2 + dt^2$ in some cylindrical coordinate system (s, t) near each puncture. This defines a natural volume form $\mu_g = g(j\cdot, \cdot)$ on $\dot{\Sigma}$. The metric also extends in a natural way to bundles of alternating forms $\Lambda^k T^* \dot{\Sigma} \rightarrow \dot{\Sigma}$, in particular the cotangent bundle $T^* \dot{\Sigma}$. There is a Hodge star operator $*$: $\Lambda^k T^* \dot{\Sigma} \rightarrow \Lambda^{2-k} T^* \dot{\Sigma}$, defined so that for any two k -forms α and β , $g(\alpha, \beta) \mu_g = \alpha \wedge * \beta$. For 1-forms, the Hodge star does not depend on g : in conformal coordinates (s, t) , we have $*ds = dt$ and $*dt = -ds$.

Choose next a Hermitian metric $\langle \cdot, \cdot \rangle$ on the bundle E , by which we mean a real-valued inner product that is compatible with the complex structure i . Then combining this with the metric g , there are natural inner products on the bundles of E -valued forms $\Lambda^{p,q} T^* \dot{\Sigma} \otimes E$. Note that $\Lambda^{1,0} T^* \dot{\Sigma} \otimes E$ and $\Lambda^{0,1} T^* \dot{\Sigma} \otimes E$ are mutually orthogonal subspaces of $\Lambda^1 T^* \dot{\Sigma} \otimes E$. These structures determine a natural L^2 inner product for sections of E :

$$\langle v, w \rangle_{L^2} = \int_{\dot{\Sigma}} \langle v, w \rangle \mu_g,$$

and similarly for sections of $F = \Lambda^{0,1} T^* \dot{\Sigma} \otimes E$.

Corresponding to the operator \mathbf{L}_0 , there is a formal adjoint $\mathbf{L}_0^* : W_\ell^{1,p}(F) \rightarrow L^p(E)$, with the property that for all smooth sections $v \in C_{0,\ell}^\infty(E)$ and $\eta \in C_{0,\ell}^\infty(F)$ with compact support

$$\langle \eta, \mathbf{L}_0 v \rangle_{L^2} = \langle \mathbf{L}_0^* \eta, v \rangle_{L^2}.$$

Here $C_{0,\ell}^\infty(F)$ and $W_\ell^{1,p}(F)$ are defined as spaces of sections $\eta : \dot{\Sigma} \rightarrow F = \Lambda^{0,1} T^* \dot{\Sigma} \otimes E$ that satisfy the totally real boundary condition $\eta(z)Y \in \ell_z$ for all $z \in \partial\Sigma$, $Y \in T_z(\partial\Sigma)$. Then \mathbf{L}_0^* is conjugate to a Cauchy-Riemann type operator of the same class as \mathbf{L}_0 , and it turns out that $\text{Ind } \mathbf{L}_0^* = -\text{Ind } \mathbf{L}_0$. In fact, one can identify the kernel of \mathbf{L}_0 with the cokernel of \mathbf{L}_0^* and vice versa; in particular \mathbf{L}_0 is surjective if and only if \mathbf{L}_0^* is injective. This idea is a key ingredient in the proof of the Fredholm property for \mathbf{L}_0 (cf. [MS04], [Sch96]).

Naturally, if \mathbf{L}_0 is surjective then so is \mathbf{L} , but in general this would be too much to hope for. Much better results are obtained by deriving a formal adjoint for \mathbf{L} itself. This will force us to consider a slightly new type of boundary condition.

Recall that the boundary condition for sections in the domain of \mathbf{L} is determined by an orientable totally real subbundle $\ell \subset E|_{\partial\Sigma}$ and a section $\zeta : \partial\Sigma \rightarrow E \setminus \ell$. We can alter ζ without altering the boundary condition in order to assume that ζ takes values in the orthogonal complement of ℓ . Suppose $X(F)$ is a space of continuous

sections (of class C_0^∞ , $W^{k,p}$ etc.) of F . Then define $X_{\ell_0}(F)$ to be the space of sections $\eta \in X(F)$ such that

- (i) $\eta(z)Y \in \ell_z$ for all $z \in \partial\Sigma$ and $Y \in T_z(\partial\Sigma)$,
- (ii) for each component $\gamma_j \subset \partial\Sigma$,

$$\int_{\gamma_j} \langle *\eta, \zeta \rangle = 0. \quad (4.5.7)$$

Here $\langle *\eta, \zeta \rangle$ is a real-valued 1-form on $\partial\Sigma$, defined for $z \in \partial\Sigma$, $Y \in T_z(\partial\Sigma)$ by $\langle *\eta, \zeta \rangle(Y) = \langle *(\eta(z))Y, \zeta(z) \rangle$.

Note that $X_{\ell_0}(F)$ is a subspace of $X_\ell(F)$ with codimension m : the normalization condition (4.5.7) kills one dimension for each component of $\partial\Sigma$. This inclusion is, in a sense, the dualization of the inclusion $X_\ell(E) \subset X_{\ell_\zeta}(E)$.

Define $\mathbf{L}^* : W_{\ell_0}^{1,p}(F) \rightarrow L^p(E)$ as the restriction of \mathbf{L}_0^* . It follows immediately from Lemma 4.5.16 that \mathbf{L}^* is Fredholm, with index

$$\text{Ind } \mathbf{L}^* = \text{Ind } \mathbf{L}_0^* - m = -\text{Ind } \mathbf{L}_0 - m = -\text{Ind } \mathbf{L}.$$

Moreover, a simple computation yields:

Lemma 4.5.32. *For all $v \in C_{0,\ell_\zeta}^\infty(E)$ and $\eta \in C_{0,\ell_0}^\infty(F)$,*

$$\langle \eta, \mathbf{L}v \rangle_{L^2} = \langle \mathbf{L}^*\eta, v \rangle_{L^2}.$$

Now applying elliptic regularity as in [MS04], [Sch96], we have:

Proposition 4.5.33. *The cokernel of \mathbf{L} is isomorphic to the kernel of \mathbf{L}^* .*

Corollary 4.5.34. *\mathbf{L} is surjective if and only if \mathbf{L}^* is injective.*

We now turn our attention to the question of what conditions will guarantee that \mathbf{L}^* is injective. Once again, the issue hinges on the zero sets of sections $\eta \in \ker \mathbf{L}^*$. Since \mathbf{L}^* is conjugate to a Cauchy-Riemann type operator, any section $\eta \in \ker \mathbf{L}^*$ satisfies the similarity principle as in Lemma 4.5.28: so all zeros are isolated and positive. This is also true at the boundary, since η satisfies a totally real boundary condition. In light of this, Theorem 4.5.29 applies to η as well, and we have

$$0 \leq 2N(\eta) \leq \mu(F, \mathcal{B}_{\mathbf{L}^*}) - \#\Gamma_1.$$

The lower bound can be improved however, using the normalization condition (4.5.7). Indeed, on each component $\gamma_j \subset \partial\Sigma$, η must be zero somewhere, or else the integrand in (4.5.7) would always have the same sign. Thus there is at least one zero on γ_j . If this zero has order 1, then it is a transverse intersection of $\eta|_{\gamma_j}$ with the zero section of $\ell|_{\gamma_j}$, and therefore there must be another one. We've proved:

Proposition 4.5.35. *Let $\eta \in W_{\ell_0}^{1,p}(F)$ be a section in $\ker \mathbf{L}^*$ which is not identically zero. Then η has finitely many zeros, and $2m \leq 2N(\eta) \leq \mu(F, \mathcal{B}_{\mathbf{L}^*}) - \#\Gamma_1$.*

This is enough to prove the main result of this section.

Theorem 4.5.36. *Let $\mathbf{L} : W_{\ell_\zeta}^{1,p}(E) \rightarrow L^p(F)$ be the Fredholm operator described above. If $\text{Ind } \mathbf{L} \geq 2g + \#\Gamma_0 - 1$, then \mathbf{L} is surjective.*

Remark 4.5.37. *The hypothesis technically allows $\text{Ind } \mathbf{L} = -1$, but this will never happen in practice. That's because the inequality would then require $\#\Gamma_0 = 0$, in which case, as remarked in the proof of Theorem 4.5.30, the index is always even.*

Proof of Theorem 4.5.36. Assume $\text{Ind } \mathbf{L} = \mu(E, \mathcal{B}_{\mathbf{L}}) + \chi(\dot{\Sigma}) + m \geq 2g + \#\Gamma_0 - 1 = -\chi(\dot{\Sigma}) - \#\Gamma_1 - m + 1$, and thus

$$\mu(E, \mathcal{B}_{\mathbf{L}}) + 2\chi(\dot{\Sigma}) \geq -2m - \#\Gamma_1 + 1. \quad (4.5.8)$$

We have $\text{Ind } \mathbf{L}_0^* = \mu(F, \mathcal{B}_{\mathbf{L}^*}) + \chi(\dot{\Sigma}) = -\text{Ind } \mathbf{L}_0 = -\mu(E, \mathcal{B}_{\mathbf{L}}) - \chi(\dot{\Sigma})$, which implies $\mu(E, \mathcal{B}_{\mathbf{L}}) = -\mu(F, \mathcal{B}_{\mathbf{L}^*}) - 2\chi(\dot{\Sigma})$. Plugging this into (4.5.8), we find $\mu(F, \mathcal{B}_{\mathbf{L}^*}) \leq 2m + \#\Gamma_1 - 1$, and thus $\mu(F, \mathcal{B}_{\mathbf{L}^*}) - \#\Gamma_1 \leq 2m - 1 < 2m$, which contradicts Prop. 4.5.35 if there are any nontrivial sections in $\ker \mathbf{L}^*$. Therefore \mathbf{L}^* is injective, and it follows from Corollary 4.5.34 that \mathbf{L} is surjective. \square

Corollary 4.5.38. *Suppose $\tilde{u} : \dot{\Sigma} \rightarrow W$ is a solution to Problem (BP'), defined on a Riemann surface with genus g , $m \geq 0$ boundary components and even/odd punctures $\Gamma = \Gamma_0 \cup \Gamma_1$. Then the following is a sufficient condition for the linearization $\mathbf{L}_{\tilde{u}}$ to be surjective:*

$$\boxed{\text{Ind}(\tilde{u}) \geq 2g + \#\Gamma_0 - 1.}$$

Proof. By Prop. 4.5.22, it suffices to prove surjectivity for the operator $\mathbf{L}_{\tilde{u},+} : C_{\Gamma, \ell_\zeta}^{1+\alpha, \epsilon'}(E) \rightarrow C_{\Gamma}^{\alpha, \epsilon'}(F)$, or equivalently

$$\mathbf{L}_{\tilde{u},+}^{\epsilon'} : W_{\ell_\zeta}^{1,p}(E) \rightarrow L^p(F).$$

Since $\mu(E, \mathcal{B}_{\mathbf{L}_{\tilde{u},+}^{\epsilon'}}) = \mu(E, \mathcal{B}_{\mathbf{L}_{\tilde{u}}})$, the result follows by applying Theorem 4.5.36 to $\mathbf{L}_{\tilde{u},+}^{\epsilon'}$. \square

The same argument works for the restricted operator $\mathbf{L}_{\tilde{u},z}$ at any puncture $z \in \Gamma$ with a Morse-Bott asymptotic limit, but there's one caveat: the Conley-Zehnder index of the perturbed operator at this puncture is now altered by one, thus changing $\#\Gamma_0$. Accounting for this, we obtain:

Corollary 4.5.39. *Suppose the solution $\tilde{u} : \dot{\Sigma} \rightarrow W$ to (\mathbf{BP}') has a puncture $z \in \Gamma$ with a Morse-Bott asymptotic limit, and denote its parity (in the sense of Sec. 4.2.3) by $p(z) \in \{0, 1\}$. Then the following is a sufficient condition for the restricted linearization $\mathbf{L}_{\tilde{u}, z}$ to be surjective:*

$$\boxed{\text{Ind}(\tilde{u}) \geq 2g + \#\Gamma_0 - (-1)^{p(z)}}.$$

The same argument using the formal adjoint of \mathbf{L}_0 leads to a more direct generalization of the result from [HLS97]:

Theorem 4.5.40. *Suppose (W, \hat{J}) is an almost complex 4-manifold with cylindrical ends, and $\tilde{u} : \Sigma \setminus \Gamma \rightarrow W$ is an asymptotically cylindrical \hat{J} -holomorphic curve defined on a Riemann surface with genus g , finitely many punctures $\Gamma \subset \text{int } \Sigma$ and $m \geq 0$ boundary components. Assume all the asymptotic limits are nondegenerate or Morse-Bott, and \tilde{u} satisfies a fixed totally real boundary condition. Then the linearization of this problem is surjective if*

$$\boxed{\text{Ind}(\tilde{u}) \geq 2g + m + \#\Gamma_0 - 1}.$$

The special case with $\partial\Sigma = \emptyset$ and nondegenerate asymptotic limits (i.e. \tilde{u} is a nondegenerate finite energy surface) is a folk theorem which provides useful criteria for proving stability of finite energy foliations. We'll use these results similarly for a foliation of Morse-Bott type in Chapter 5.

Now that all of the important formulas have been stated and proved, it's worth taking a moment to revisit some of them in slightly different forms. In particular, combining the upper bound in Theorem 4.5.29 with the Fredholm index formula of Corollary 4.5.24, we get

$$\boxed{2N(v) \leq \text{Ind}(\tilde{u}) + 2g + \#\Gamma_0 - 2} \tag{4.5.9}$$

for any solution \tilde{u} of (\mathbf{BP}') with genus g and even punctures Γ_0 , and any section v in the kernel of the linearized operator $\mathbf{L}_{\tilde{u}}$. For a solution of Problem (\mathbf{BP}) on the symplectization $\mathbb{R} \times M$, combining the wind_π estimate of Theorem 4.3.7 with the index formula produces a strikingly similar result:

$$\boxed{2 \text{wind}_\pi(\tilde{u}) \leq \text{Ind}(\tilde{u}) + 2g + \#\Gamma_0 - 2} \tag{4.5.10}$$

These two inequalities are most of the reason why the theory of finite energy foliations works so well when the genus is zero and even punctures are kept to a minimum, but in more general cases requires some modification (cf. [ACH04]).

4.5.6 Implicit function theorem

Here we apply the results of the previous sections in order to understand the local structure of the moduli space $\mathcal{M}(\hat{J}, L)$. The first and simplest result along these lines follows from Corollaries 4.5.38 and 4.5.39, together with the implicit function theorem.

Theorem 4.5.41. *Suppose $\tilde{u} : \dot{\Sigma} \rightarrow W$ is a solution to (\mathbf{BP}') defined on a surface with punctures $\Gamma = \Gamma_0 \cup \Gamma_1$, genus g and m boundary components.*

- (i) *If $\text{Ind}(\tilde{u}) \geq 2g + \Gamma_0 - 1$, then the connected component $\mathcal{M}_{\tilde{u}} \subset \mathcal{M}(\hat{J}, L)$ containing \tilde{u} admits the structure of a smooth manifold, with $\dim \mathcal{M}_{\tilde{u}} = \text{Ind}(\tilde{u})$.*
- (ii) *Suppose \tilde{u} has a Morse-Bott asymptotic limit at $z \in \Gamma$ with parity $p(z) \in \{0, 1\}$, and let*

$$\mathcal{M}_{\tilde{u}}^z = \{\tilde{v} \in \mathcal{M}_{\tilde{u}} \mid \tilde{v} \text{ and } \tilde{u} \text{ have the same asymptotic limit at } z\}.$$

Then if $\text{Ind}(\tilde{u}) \geq 2g + \Gamma_0 - (-1)^{p(z)}$, $\mathcal{M}_{\tilde{u}}^z$ admits the structure of a smooth manifold, with $\dim \mathcal{M}_{\tilde{u}}^z = \text{Ind}(\tilde{u}) - 1$.

Note that no genericity assumption is required for \hat{J} .

We focus next on the situation of greatest interest for the surgery arguments in Chapter 5, where $g = \#\Gamma_0 = 0$. In this case, we can show that \tilde{u} and its neighbors have properties well suited to finite energy foliations. The following results generalize Theorems 1.5 and 1.6 in [HWZ99].

Theorem 4.5.42. *Let $\Sigma = S^2 \setminus \bigcup_{j=1}^m \mathcal{D}_j$ be a sphere with $m \geq 0$ disjoint open disks removed, and suppose $\tilde{u} : \dot{\Sigma} \rightarrow W$ is a solution of (\mathbf{BP}') with $\text{Ind}(\tilde{u}) = 2$, such that all asymptotic orbits are simply covered and all punctures are odd. Then there exists an open ball $0 \in B_\delta^2(0) \subset \mathbb{R}^2$ and an embedding*

$$\tilde{F} : B_\delta^2(0) \times \dot{\Sigma} \rightarrow W,$$

such that:

- (i) *For $\tau \in B_\delta^2(0)$, the maps $\tilde{u}_\tau = \tilde{F}(\tau, \cdot) : \dot{\Sigma} \rightarrow W$ are solutions to (\mathbf{BP}') , and $\tilde{u}_0 = \tilde{u}$.*
- (ii) *For any puncture $z \in \Gamma$ where \tilde{u} has a Morse-Bott asymptotic limit, the set*

$$\{\tau \in B_\delta^2(0) \mid \tilde{u}_\tau \text{ and } \tilde{u} \text{ have the same asymptotic limit at } z\}$$

is a smooth 1-dimensional submanifold of $B_\delta^2(0)$.

(iii) If $\tilde{v}_k : \dot{\Sigma} \rightarrow W$ is a sequence of solutions to **(BP')** converging to \tilde{u} in $\mathcal{M}(\hat{J}, L)$, then for sufficiently large k there is a sequence $\tau_k \rightarrow 0 \in B_\delta^2(0)$ such that $\tilde{v}_k = \tilde{u}_{\tau_k} \circ \varphi_k$ for some diffeomorphisms $\varphi_k : \dot{\Sigma} \rightarrow \dot{\Sigma}$.

Remark 4.5.43. *The theorem intentionally makes no mention of any conformal structure on Σ : it may well happen that nearby solutions \tilde{u} and \tilde{u}_τ are \hat{J} -holomorphic with respect to nonequivalent conformal structures j and j_τ . (The moduli space of conformal structures is nontrivial if $m \geq 2$.)*

This can be refined further in the \mathbb{R} -invariant case.

Theorem 4.5.44. *Suppose $\tilde{u} = (a, u) : \dot{\Sigma} \rightarrow \mathbb{R} \times M$ is an embedded solution to **(BP₀)**, satisfying the same hypotheses as in Theorem 4.5.42, and assume additionally that either $\partial\Sigma = \emptyset$ or $u : \dot{\Sigma} \rightarrow M$ is injective and does not intersect its asymptotic limits. Then there exists a number $\delta > 0$ and an embedding*

$$\begin{aligned} \mathbb{R} \times (-\delta, \delta) \times \dot{\Sigma} &\xrightarrow{\tilde{F}} \mathbb{R} \times M \\ (\sigma, \tau, z) &\longmapsto (a_\tau(z) + \sigma, u_\tau(z)) \end{aligned}$$

such that:

- (i) For $\sigma \in \mathbb{R}$ and $\tau \in (-\delta, \delta)$, the maps $\tilde{u}_{(\sigma, \tau)} = \tilde{F}(\sigma, \tau, \cdot) : \dot{\Sigma} \rightarrow \mathbb{R} \times M$ are (up to parametrization) embedded solutions to **(BP₀)**, and $\tilde{u}_{(0,0)} = \tilde{u}$.
- (ii) The map $F(\tau, z) = u_\tau(z)$ is an embedding $(-\delta, \delta) \times \dot{\Sigma} \hookrightarrow M$, and its image never intersects the asymptotic limits of any $\tilde{u}_{(\sigma, \tau)}$ for $(\sigma, \tau) \in \mathbb{R} \times (-\delta, \delta)$. In particular the maps $u_\tau : \dot{\Sigma} \rightarrow M$ are embedded for each $\tau \in (-\delta, \delta)$, with mutually disjoint images which do not intersect their asymptotic limits.
- (iii) If \tilde{u} has a Morse-Bott asymptotic limit at $z \in \Gamma$, then u_τ and $u_{\tau'}$ have distinct asymptotic limits at z whenever $\tau \neq \tau'$.
- (iv) For any sequence $\tilde{v}_k : \dot{\Sigma} \rightarrow \mathbb{R} \times M$ converging to \tilde{u} in $\mathcal{M}(\tilde{J}, L)$, there is a sequence $(\sigma_k, \tau_k) \rightarrow (0, 0) \in \mathbb{R} \times (-\delta, \delta)$ such that $\tilde{v}_k = \tilde{u}_{(\sigma_k, \tau_k)} \circ \varphi_k$ for some diffeomorphisms $\varphi_k : \dot{\Sigma} \rightarrow \dot{\Sigma}$ and k sufficiently large.

Observe that in the case $\partial\Sigma = \emptyset$, the hypothesis doesn't require $u : \dot{\Sigma} \rightarrow M$ to be injective; this is rather a *consequence* of the theorem.

Proof of Theorem 4.5.42. We have $g = \#\Gamma_0 = 0$ and $\text{Ind}(\tilde{u}) = 2$, so by Theorem 4.5.30, the linearization $\mathbf{L}_{\tilde{u}}$ is surjective, and every section $v \in \ker \mathbf{L}_{\tilde{u}}$ is zero free. Applying the implicit function theorem, we obtain a smooth embedding

$$B_\delta^2(0) \rightarrow C_{\Gamma, \ell_\zeta}^{1+\alpha, \delta}(E) : \tau \mapsto v_\tau$$

such that $\mathbf{F}(v_\tau) = 0$. Moreover, after possibly decreasing δ , the arguments in [HWZ99], Theorem 5.7 show that $B_\delta^2(0) \times \dot{\Sigma} \rightarrow \mathcal{V}_0 : (\tau, z) \mapsto v_\tau(z)$ is a smooth embedding. Since the asymptotic limits are simply covered, $\Psi : \mathcal{V}_0 \rightarrow W$ is also an embedding, so the map

$$\tilde{F}(\tau, z) = \Psi(v_\tau(z)),$$

clearly has properties (i) and (iii). Property (ii) follows from the implicit function theorem and Corollary 4.5.39, since $\text{Ind}(\tilde{u}) = 2 \geq \pm 1 = 2g + \#\Gamma_0 - (-1)^{p(z)}$. \square

Proof of Theorem 4.5.44. Theorem 4.5.42 gives a 2-parameter family of disjoint embedded solutions $\tilde{u}_{(\sigma, \tau)} = (a_{(\sigma, \tau)}, u_{(\sigma, \tau)}) : \dot{\Sigma} \rightarrow \mathbb{R} \times M$, with $(\sigma, \tau) \in B_\delta^2(0) \subset \mathbb{R}^2$. This family must include 1-parameter families of solutions related to each other by \mathbb{R} -translation, thus we can arrange the parametrization such that $u_{(\sigma, \tau)}(\dot{\Sigma}) = u_{(\sigma', \tau')}(\dot{\Sigma})$ if and only if $\tau = \tau'$. The solutions can then be reparametrized smoothly to produce an embedding of the form

$$B_\delta^2(0) \times \dot{\Sigma} \rightarrow \mathbb{R} \times M : (\sigma, \tau, z) \mapsto \tilde{u}_{(\sigma, \tau)} = (a_\tau(z) + \sigma, u_\tau(z)).$$

Using the \mathbb{R} -invariance, this extends naturally to an immersion $\mathbb{R} \times (-\delta, \delta) \times \dot{\Sigma} \rightarrow \mathbb{R} \times M$, and we must show that this map is injective.

Observe that by the inequality (4.5.10), $\text{wind}_\pi(\tilde{u}_{(\sigma, \tau)}) = 0$, so $u_\tau : \dot{\Sigma} \rightarrow M$ is necessarily immersed for each $\tau \in (-\delta, \delta)$. We show now that $u = u_0$ must also be injective and disjoint from its asymptotic limits if $\partial\Sigma = \emptyset$. If u is not injective, then $\tilde{u}_{(0,0)}$ intersects $\tilde{u}_{(\sigma,0)}$ for some $\sigma \neq 0$. But this is clearly not the case for any σ in a neighborhood of 0, and applying positivity of intersections to the natural homotopy from $\tilde{u}_{(0,0)}$ to $\tilde{u}_{(\sigma,0)}$, we find a contradiction. Therefore u is an embedding, and it follows that it cannot intersect any of its asymptotic limits: such an intersection would necessarily be transverse, thus implying a self-intersection of u .

The above intersection argument doesn't work so well when $\partial\Sigma \neq \emptyset$; something extra is needed to prevent intersections from appearing or disappearing at the boundary under \mathbb{R} -translation. This is why we include the injectivity of u as a hypothesis in this case. It still follows that u is embedded and disjoint from its asymptotic limits, since $\text{wind}_\pi(\tilde{u}) = 0$.

We can now assume, possibly by shrinking δ , that u_τ is embedded and disjoint from its asymptotic limits for each $\tau \in (-\delta, \delta)$. We claim that u_τ and $u_{\tau'}$ do not intersect if $\tau \neq \tau'$. To see this, we use again the fact that sections $v : \dot{\Sigma} \rightarrow \nu\tilde{u}$ in $\ker \mathbf{L}_{\tilde{u}}$ have no zeros: it follows that any two such sections spanning $\ker \mathbf{L}_{\tilde{u}}$ are *pointwise* linearly independent. Thus if $v_{\mathbb{R}}$ and w form a basis for $\ker \mathbf{L}_{\tilde{u}}$, where $v_{\mathbb{R}}$ is derived by differentiating the \mathbb{R} -invariant family $\sigma \mapsto \tilde{u}_{(\sigma,0)}$, we conclude that $p_*w(z) \in T_{u(z)}M$ is everywhere nonzero, where $p : \mathbb{R} \times M \rightarrow M$ is the projection.

There is then a 1-dimensional curve $(\sigma(t), \tau(t))$ through $(0, 0)$ such that $(t, z) \mapsto u_{\tau(t)}(z)$ is injective for t sufficiently close to 0, proving the claim.

It follows now that u_τ doesn't intersect the asymptotic limits of $u_{\tau'}$ if $\tau \neq \tau'$; again such an intersection would be transverse, leading to an intersection of u_τ with $u_{\tau'}$.

It remains to prove (iii), that u_τ and $u_{\tau'}$ have distinct limits at any Morse-Bott puncture if $\tau \neq \tau'$. This follows from the second statement in Theorem 4.5.44, because in this case we can uniquely identify the 1-parameter family $\tilde{u}_{(\sigma(t), \tau(t))}$ that shares the same limit with $\tilde{u}_{(0,0)}$: it is the family of \mathbb{R} -translations $\tilde{u}_{(\sigma,0)}$. \square

4.5.7 Parametrized deformations

The theorems of the previous section show that the moduli space of index 2 solutions to (\mathbf{BP}_0) or (\mathbf{BP}') is locally very well behaved. If there is also compactness, then one obtains a foliation of (some subset of) the four-manifold W by holomorphic curves. This is precisely the kind of argument that was used to produce open book decompositions in [HWZ95b], and we will see more examples when we carry out the necessary compactness arguments in Chapter 5.

In this section we assume that such a compact moduli space is given, and ask the following question: if \hat{J} is perturbed, does this compact family change continuously along with \hat{J} ? The answer, of course, is “yes” for the cases we're interested in. The hard parts of the proof are already done—it only remains to synthesize the ingredients.

The general framework is as follows: let $\{\hat{J}_r\}_{r \in \mathbb{R}}$ be a smooth family of almost complex structures on W which have asymptotically cylindrical behavior, i.e. \hat{J}_r is defined on the ends E_\pm in terms of a smooth family of contact forms λ_r^\pm , and a smooth family of admissible complex multiplications J_r^\pm on $\xi_r^\pm = \ker \lambda_r^\pm$. Assume there are open subsets $\mathcal{U}_\pm \subset M_\pm$ in which λ_r^\pm and J_r^\pm are independent of r , and these subsets contain compact submanifolds \mathcal{P}_\pm consisting of nondegenerate periodic orbits and/or simple Morse-Bott families of periodic orbits, with respect to λ_r^\pm . The domain for maps into W will be a fixed compact oriented surface Σ with boundary, with a finite set of fixed punctures $\Gamma \subset \text{int } \Sigma$. We will require that these maps be asymptotic to orbits from \mathcal{P}_\pm at the positive/negative punctures. For each connected component $\gamma_j \subset \partial\Sigma$, we define the boundary condition $\tilde{u}(\gamma_j) \subset L_\tau$ for any $\tau \in I_j$, where I_j is a connected 1-manifold and $L_\tau = \iota_j(\{\tau\} \times \Lambda_j)$ is a smooth family of surfaces that are totally real with respect to \hat{J}_r for all $r \in \mathbb{R}$. The map $\iota_j : I_j \times \Lambda_j \rightarrow W$ is an embedding, with Λ_j a closed connected 2-manifold. Solutions $\tilde{u} : \dot{\Sigma} \rightarrow W$ will additionally be required to be globally embedded, and transverse to ι_j at γ_j . All of this is the same as in our original definition of Problem (\mathbf{BP}') :

the only new element here is that we require the boundary data at both $\partial\Sigma$ and Γ to be compatible with all almost complex structures from the family \hat{J}_r , whereas previously there was only one choice of \hat{J} to worry about.

In this context, we can pick any $r \in \mathbb{R}$ and speak of \hat{J}_r -holomorphic solutions to Problem **(BP')**. This defines moduli spaces,

$$\begin{aligned}\mathcal{M}_r &= \mathcal{M}(\hat{J}_r, L), \\ \mathcal{M} &= \{(r, \tilde{u}) \mid r \in \mathbb{R}, \tilde{u} \in \mathcal{M}_r\}.\end{aligned}$$

Recall that two solutions \tilde{u} and \tilde{v} define the same element of \mathcal{M}_r if there is a diffeomorphism $\varphi : \dot{\Sigma} \rightarrow \dot{\Sigma}$ such that $\tilde{v} = \tilde{u} \circ \varphi$. Also, from Definition 4.5.3, $\tilde{u}_k \rightarrow \tilde{u}$ in \mathcal{M}_r if the maps can be reparametrized on $\dot{\Sigma}$ so that $\tilde{u}_k \rightarrow \tilde{u}$ in $C_{\text{loc}}^\infty(\dot{\Sigma}, W)$ and there are well defined continuous extensions with $\bar{u}_k \rightarrow \bar{u}$ in $C^0(\bar{\Sigma}, \bar{W})$. A topology on \mathcal{M} is defined by saying that $(r_k, \tilde{u}_k) \rightarrow (r, \tilde{u})$ if $r_k \rightarrow r$ in \mathbb{R} and $\tilde{u}_k \rightarrow \tilde{u}$ in the sense just described. Then the natural inclusion $\mathcal{M}_r \hookrightarrow \mathcal{M} : \tilde{u} \mapsto (r, \tilde{u})$ is continuous.

For a given $r \in \mathbb{R}$, \mathcal{M}_r is not generally a smooth manifold, but it may have components that are. This is the case in particular for any connected component $\mathcal{M}_r^* \subset \mathcal{M}_r$ containing a solution \tilde{u} for which $\text{Ind}(\tilde{u}) \geq 2g + \#\Gamma_0 - 1$. In this case we can show that the corresponding component $\mathcal{M}^* \subset \mathcal{M}$ is also a manifold, containing \mathcal{M}_r^* as a hypersurface.

We use the same setup that was used to analyze the space \mathcal{M}_r . Assume $(0, \tilde{u}) \in \mathcal{M}$, and construct an open neighborhood $\mathcal{V} \subset \nu\tilde{u}$ of the zero section, along with an immersion

$$\Psi : \mathcal{V} \rightarrow W$$

mapping the zero section to $\tilde{u}(\dot{\Sigma})$, as in Sec. 4.5.1. The 1-parameter family of almost complex structures $\bar{J}_r = \Psi^* \hat{J}_r$ is independent of r outside of $\mathcal{V}|_K$ for some compact subset $K \subset \dot{\Sigma}$. Define a Banach space bundle $\tilde{\mathcal{E}} \rightarrow \tilde{\mathcal{B}}$ with

$$\begin{aligned}\tilde{\mathcal{B}} &= \mathbb{R} \times \mathcal{B}, \\ \tilde{\mathcal{E}}_{(r,v)} &= C_\Gamma^{\alpha,\epsilon}(\text{Hom}_{\mathbb{R}}(\Lambda^2 T\dot{\Sigma}, v^* \Theta^r)),\end{aligned}$$

where for each $r \in \mathbb{R}$, $\Theta^r \subset \Lambda^2 T\mathcal{V} \rightarrow \mathcal{V}$ is the subbundle whose fibers are the (-1) -eigenspaces of \bar{J}_r . We then have a smooth section $\tilde{\mathbf{F}} : \tilde{\mathcal{B}} \rightarrow \tilde{\mathcal{E}} : v \mapsto \bar{\eta}_{\bar{J}_r}(v)$, where

$$\bar{\eta}_{\bar{J}_r}(v)(z) : h \wedge k \mapsto Tv(h) \wedge Tv(k) - \bar{J}_r Tv(h) \wedge \bar{J}_r Tv(k).$$

Clearly a neighborhood of $(0, \tilde{u})$ in \mathcal{M} is homeomorphic to a neighborhood of $(0, 0)$ in $\tilde{\mathbf{F}}^{-1}(0) \subset \tilde{\mathcal{B}}$.

Notice that if we set $\mathcal{B}^r = \{r\} \times \tilde{\mathcal{B}}$ and $\mathcal{E}^r = \tilde{\mathcal{E}}|_{\mathcal{B}^r}$ for any $r \in \mathbb{R}$, the restriction $\tilde{\mathbf{F}}|_{\mathcal{B}^r} : \mathcal{B}^r \rightarrow \mathcal{E}^r$ is precisely the problem we have already considered. Choose a local trivialization of $\tilde{\mathcal{E}} \rightarrow \tilde{\mathcal{B}}$ near $(0,0)$, so we can regard $\tilde{\mathbf{F}}$ as a map between Banach spaces. The following lemma then gives the local structure of $\tilde{\mathbf{F}}^{-1}$ near $(0,0)$.

Lemma 4.5.45. *Suppose X and Y are Banach spaces, $\mathcal{U} \subset X$ is an open neighborhood of 0 , and $F : \mathbb{R} \times \mathcal{U} \rightarrow Y$ is a smooth map with $F(0,0) = 0$. For any $r \in \mathbb{R}$, denote $F_r : \mathcal{U} \rightarrow Y : x \mapsto F(r,x)$, and assume F has the property that $dF_0(0) : X \rightarrow Y$ is a surjective Fredholm operator with index N . Then there is a neighborhood \mathcal{U}' of $(0,0) \in \mathbb{R} \times X$ such that $F^{-1}(0) \cap \mathcal{U}' \subset \mathbb{R} \times \mathcal{U}$ is a smooth $(N+1)$ -dimensional manifold transverse to the hyperplanes $\{r\} \times X$ for all $r \in \mathbb{R}$.*

Proof. The linearization of F at $(r,x) \in \mathbb{R} \times \mathcal{U}$ takes the form

$$dF(r,x)(h,y) = h \frac{\partial F}{\partial r} + dF_r(x)y$$

for $(h,y) \in \mathbb{R} \oplus X$. Thus $dF(0,0)$ is clearly surjective if $dF_0(0)$ is, and we can apply the implicit function theorem to derive a manifold structure for $F^{-1}(0)$ near $(0,0)$. The index of $dF(0)$ is one higher than that of $dF_0(0)$, by Lemma 4.5.16. Taking a neighborhood of $(0,0)$ small enough so that $dF_r(x)$ remains surjective, there is always a solution to the equation $dF_r(x)y = -\frac{\partial F}{\partial r}(r,x)$, hence $(1,y) \in \ker dF(r,x)$, proving the transversality. \square

Corollary 4.5.46. *Suppose $(r,\tilde{u}) \in \mathcal{M}$ and $\mathbf{L}_{\tilde{u}}$ is surjective. Then \mathcal{M}_r and \mathcal{M} are both smooth manifolds in a neighborhood of \tilde{u} or (r,\tilde{u}) respectively, with $\dim \mathcal{M} = \dim \mathcal{M}_r + 1 = \text{Ind}(\tilde{u}) + 1$. The natural inclusions $\mathcal{M}_{r'} \hookrightarrow \mathcal{M}$ are smooth embeddings for (r',\tilde{u}') near (r,\tilde{u}) .*

This implies the existence of $\tilde{J}_{r'}$ -holomorphic solutions near \tilde{u} for r' near r .

Consider now the following situation. Suppose $\tilde{u}_0 \in \mathcal{M}_0$ with $\text{Ind}(\tilde{u}_0) \geq 2g + \#\Gamma_0 - 1$, so $\mathbf{L}_{\tilde{u}_0}$ is automatically surjective, and denote by $\mathcal{M}_0^* \subset \mathcal{M}_0$ the connected component containing \tilde{u}_0 ; similarly, let \mathcal{M}^* denote the connected component of \mathcal{M} containing $(0,\tilde{u}_0)$. The transversality criterion is homotopy invariant, thus we conclude that $\mathbf{L}_{\tilde{u}}$ is surjective for every $(r,\tilde{u}) \in \mathcal{M}^*$, and \mathcal{M}^* is a manifold of dimension $\text{Ind}(\tilde{u}_0) + 1$. Denote $\mathcal{M}_r^* = \{\tilde{u} \in \mathcal{M}_r \mid (r,\tilde{u}) \in \mathcal{M}^*\}$ for any $r \in \mathbb{R}$; these are smooth hypersurfaces, due to the transversality statement in Lemma 4.5.45. The question now arises as to how the hypersurfaces \mathcal{M}_r^* and \mathcal{M}_0^* might be related for $r \neq 0$. Under the right circumstances, it's not hard to prove that \mathcal{M}_r^* is diffeomorphic to \mathcal{M}_0^* . Observe that there is a natural smooth function

$$h : \mathcal{M}^* \rightarrow \mathbb{R} : (r,\tilde{u}) \mapsto r.$$

Proposition 4.5.47. *h has no critical points.*

Proof. This is just another version of the transversality statement in Lemma 4.5.45. \square

Thus we can think of h as a Morse function on the manifold \mathcal{M}^* . If \mathcal{M}^* happens to be compact, we can follow the usual prescription of classical Morse theory: choose a metric on \mathcal{M}^* and use the normalized gradient flow of h to obtain diffeomorphisms $\mathcal{M}_0^* \cong \mathcal{M}_r^*$ (cf. [Mi63]). Of course, moduli spaces of holomorphic curves are often not compact, but admit natural compactifications: this turns \mathcal{M}^* into $\overline{\mathcal{M}}^*$, which is something resembling a manifold with boundary. A simpler remedy is available for Problem **(BP₀)**, in which \mathcal{M}^* is manifestly noncompact due to \mathbb{R} -invariance: we consider instead the quotient \mathcal{M}^*/\mathbb{R} .

One piece of terminology: for any solution $\tilde{u} = (a, u) : \dot{\Sigma} \rightarrow \mathbb{R} \times M$ to Problem **(BP)**, its *contact area* is the nonnegative number

$$\mathcal{A}_\lambda(\tilde{u}) = \int_{\dot{\Sigma}} u^* d\lambda.$$

This equals zero if and only if the image of u is contained in a closed Reeb orbit. A simple argument given in the next section (Prop. 4.6.1) shows that $\mathcal{A}_\lambda(\tilde{u})$ is constant on any connected moduli space of solutions to **(BP)** with fixed data.

Lemma 4.5.48. *Fix an \mathbb{R} -invariant almost complex structure \tilde{J} of the usual type on $\mathbb{R} \times M$, and denote by L an \mathbb{R} -invariant boundary condition for Problem **(BP₀)**, with solutions forming the moduli space $\mathcal{M}(\tilde{J}, L)$. Suppose $\mathcal{M}^*(\tilde{J}, L) \subset \mathcal{M}(\tilde{J}, L)$ is a connected component with the property that $\mathcal{A}_\lambda(\tilde{u}) > 0$ for all $\tilde{u} \in \mathcal{M}^*(\tilde{J}, L)$. Then the natural \mathbb{R} -action on $\mathcal{M}^*(\tilde{J}, L)$ is free and proper. In particular, then, if $\mathcal{M}^*(\tilde{J}, L)$ is an N -dimensional manifold, $\mathcal{M}^*(\tilde{J}, L)/\mathbb{R}$ is a manifold of dimension $N - 1$.*

Proof. Given $\tilde{u} = (a, u) \in \mathcal{M}^*(\tilde{J}, L)$, write the \mathbb{R} -action by $\sigma(\tilde{u}) := \tilde{u}^\sigma := (a + \sigma, u) \in \mathcal{M}^*(\tilde{J}, L)$ for $\sigma \in \mathbb{R}$. Pick any compact subset $K \subset \mathcal{M}^*(\tilde{J}, L)$. Then to prove that \mathbb{R} acts properly, we must exclude the possibility of a diverging sequence $\sigma_k \rightarrow \pm\infty$ such that $\sigma_k(K)$ intersects K for all k . Assume there is such a sequence, so there exist $\tilde{u}_k = (a_k, u_k) \in K$ and $\tilde{v}_k = (b_k, v_k) \in K$ such that $\tilde{u}_k^{\sigma_k} = \tilde{v}_k$ up to parametrization. Since K is compact, we may assume $\tilde{u}_k \rightarrow \tilde{u}_\infty \in K$ and $\tilde{v}_k \rightarrow \tilde{v}_\infty \in K$, with convergence in the sense of $\mathcal{M}(\tilde{J}, L)$. We should now be more precise about parametrizations: assume there are continuous extensions $\bar{u}_k : \bar{\Sigma} \rightarrow \overline{\mathbb{R}} \times M$ such that

$$\bar{u}_k \rightarrow \bar{u}_\infty \quad \text{in } C^0(\bar{\Sigma}, \overline{\mathbb{R}} \times M),$$

and similarly

$$\overline{\tilde{v}_k \circ \varphi_k} \rightarrow \bar{v}_\infty \quad \text{in } C^0(\overline{\Sigma}, \overline{\mathbb{R}} \times M),$$

where $\varphi_k : \dot{\Sigma} \rightarrow \dot{\Sigma}$ are diffeomorphisms such that $\tilde{v}_k \circ \varphi_k$ extends to a continuous map $\overline{\tilde{v}_k \circ \varphi_k} : \overline{\Sigma} \rightarrow \overline{\mathbb{R}} \times M$ for all k , and

$$\tilde{v}_k = (b_k, v_k) = (a_k + \sigma_k, u_k) = \tilde{u}^{\sigma_k}.$$

Now for any $z \in \dot{\Sigma}$, let $z_k = \varphi_k^{-1}(z)$ and assume without loss of generality that $z_k \rightarrow z_\infty \in \overline{\Sigma}$. Then $\tilde{u}_k(z) \rightarrow \tilde{u}_\infty(z) = (a_\infty(z), u_\infty(z))$, and $\tilde{v}_k(z) = (a_k(z) + \sigma_k, u_k(z)) \rightarrow (\pm\infty, u_\infty(z))$. On the other hand,

$$\tilde{v}_k(z) = \overline{\tilde{v}_k \circ \varphi_k}(z_k) \rightarrow \bar{v}_\infty(z_\infty) = (\bar{b}_\infty(z_\infty), \bar{v}_\infty(z_\infty)) \in \{\pm\infty\} \times M,$$

implying that $u_\infty(z) = \bar{v}_\infty(z_\infty)$ lies in one of the asymptotic limits of \tilde{v}_∞ . This is true for arbitrary $z \in \dot{\Sigma}$, thus the image of $\tilde{u}_\infty \in K$ is contained in a periodic orbit, and we have the contradiction $\int_{\dot{\Sigma}} u_\infty^* d\lambda = 0$.

It follows immediately that the \mathbb{R} -action is also free: otherwise there exists $\sigma \in \mathbb{R} \setminus \{0\}$ and $\tilde{u} \in \mathcal{M}^*(\tilde{J}, L)$ such that $\tilde{u}^\sigma = \tilde{u}$ up to parametrization, and the same is true of $\tilde{u}^{k\sigma}$ for a sequence $k \rightarrow \infty$. \square

The same argument applies to an \mathbb{R} -invariant moduli space $\mathcal{M}^* = \bigcup_{r \in \mathbb{R}} \mathcal{M}_r$ if every $\tilde{u} \in \mathcal{M}_r$ has nonvanishing contact area. Thus in the case under consideration, \mathcal{M}^*/\mathbb{R} is also a manifold.

Given an interval $[a, b] \subset \mathbb{R}$, denote $\mathcal{M}_{[a,b]}^* = h^{-1}([a, b]) = \bigcup_{r \in [a,b]} \mathcal{M}_r^*$.

Proposition 4.5.49. *Suppose the connected moduli space $\mathcal{M}^* = \bigcup_{r \in \mathbb{R}} \mathcal{M}_r^*$ consists of solutions to (\mathbf{BP}_0) , such that some solution $\tilde{u}_0 \in \mathcal{M}_0^*$ satisfies $\text{Ind}(\tilde{u}_0) \geq 2g + \#\Gamma_0 - 1$ and every $\tilde{u} = (a, u) \in \mathcal{M}_r^*$ for $r \in \mathbb{R}$ has $\int_{\dot{\Sigma}} u^* d\lambda_r > 0$. Then \mathcal{M}^*/\mathbb{R} is a smooth manifold of dimension $\text{Ind}(\tilde{u}_0)$. Moreover, if $0 \in [a, b]$ and $\mathcal{M}_{[a,b]}^*/\mathbb{R}$ is compact, there is a diffeomorphism*

$$\psi : [a, b] \times \mathcal{M}_0^*/\mathbb{R} \rightarrow \mathcal{M}_{[a,b]}^*/\mathbb{R}$$

such that $\psi(0, [\tilde{u}]) = [\tilde{u}]$ and for each $r \in [a, b]$, $\psi(r, \cdot)$ is a diffeomorphism $\mathcal{M}_0^*/\mathbb{R} \rightarrow \mathcal{M}_r^*/\mathbb{R}$.

Proof. This follows from the previous remarks and Lemma 4.5.48, plus the observation that the function $h : \mathcal{M}^* \rightarrow \mathbb{R}$ descends to a function $\mathcal{M}^*/\mathbb{R} \rightarrow \mathbb{R}$ which has no critical points. Then we can choose a metric on \mathcal{M}^*/\mathbb{R} and use the flow φ^t of $\nabla h/|\nabla h|^2$, defining $\psi(r, [\tilde{u}]) = \varphi^r([\tilde{u}])$. \square

We now investigate some of the consequences of this formalism for \mathbb{R} -invariant foliations. Let (M, λ) be a connected contact 3-manifold, possibly with boundary, such that X_λ is tangent to ∂M . (This implies that any component of ∂M has Euler characteristic zero, i.e. it's a torus.) Choose an admissible $J : \xi \rightarrow \xi$ and define an almost complex structure \tilde{J} on $\mathbb{R} \times M$ in the standard way. For each component $L \subset \partial M$, choose a smooth function $G : L \rightarrow \mathbb{R}$ and define the totally real submanifold $\tilde{L}_G \subset (\mathbb{R} \times M, \tilde{J})$, as at the beginning of this chapter. Its \mathbb{R} -translates \tilde{L}_G^σ foliate $\mathbb{R} \times L \subset \partial(\mathbb{R} \times M)$.

We can use Problem **(BP₀)** to generalize the notion of a stable finite energy foliation to this setting, with $\partial M \neq \emptyset$. We consider here a special case which will be useful in Chapter 5. Fix a compact oriented surface Σ with genus 0, such that $\partial\Sigma$ has at least as many components as ∂M . Fix also a finite set of positive and/or negative punctures $\Gamma = \Gamma^+ \cup \Gamma^- \subset \text{int } \Sigma$, and for each $z \in \Gamma$ choose a corresponding nondegenerate periodic orbit $P_z \subset \text{int } M$, which is simply covered and has odd Conley-Zehnder index. Denote $\mathcal{P} = \bigcup_{z \in \Gamma} P_z \subset \text{int } M$. Consider now a smooth foliation of $(\mathbb{R} \times M) \setminus (\mathbb{R} \times \mathcal{P})$ by surfaces $\{S_{(\sigma, \tau)}\}_{(\sigma, \tau) \in \mathbb{R} \times S^1}$, such that:

1. Each surface $S_{(\sigma, \tau)}$ is the image of an embedded solution $\tilde{u} : \dot{\Sigma} \rightarrow \mathbb{R} \times M$ of **(BP₀)**, positively/negatively asymptotic to P_z at $z \in \Gamma^\pm$, and with $\text{Ind}(\tilde{u}) = 2$.
2. If $S_{(\sigma, \tau)}$ is the image of $\tilde{u} = (a, u)$, then for any $c \in \mathbb{R}$, $S_{(\sigma+c, \tau)}$ is the image of $\tilde{u}_c = (a+c, u)$.
3. Let $p : \mathbb{R} \times M \rightarrow M$ be the projection. If $\tau \neq \tau'$, then $p(S_{(\sigma, \tau)})$ and $p(S_{(\sigma', \tau')})$ are disjoint embedded surfaces in M , for any choice of σ and σ' . In particular, fixing $\sigma \in \mathbb{R}$, the surfaces $\{p(S_{(\sigma, \tau)})\}_{\tau \in S^1}$ foliate $M \setminus \mathcal{P}$.

A family with these properties will be called a *stable open book decomposition with boundary*. Observe that if $\tilde{u} = (a, u) : \dot{\Sigma} \rightarrow \mathbb{R} \times M$ is any leaf, then $u : \dot{\Sigma} \rightarrow M$ is embedded and therefore transverse to X_λ , so the foliation of $M \setminus \mathcal{P}$ is transverse to ∂M .

Lemma 4.5.50. *Let \mathcal{M}_0 be the moduli space of embedded \tilde{J} -holomorphic solutions to **(BP₀)** on the manifold with boundary described above, and let $\mathcal{M}_0^* \subset \mathcal{M}_0$ be the connected component containing all the pages of a given stable open book decomposition with boundary. Then, in fact, every solution $\tilde{u} \in \mathcal{M}_0^*$ is a page of the open book decomposition.*

Proof. Denote by \mathcal{F} the subset of \mathcal{M}_0^* consisting of solutions that are part of the open book decomposition. Then an easy intersection argument shows that \mathcal{F}/\mathbb{R} is a closed subset of $\mathcal{M}_0^*/\mathbb{R}$, and it is also an open subset, by the implicit function theorem. Thus $\mathcal{F}/\mathbb{R} = \mathcal{M}_0^*/\mathbb{R}$. \square

We now ask what happens to a family of this type under homotopies of \tilde{J} . Choose smooth homotopies $\{\lambda_r\}_{r \in \mathbb{R}}$ and $\{J_r\}_{r \in \mathbb{R}}$, such that $\lambda_0 = \lambda$ and $J_0 = J$: these induce a corresponding homotopy $\{\tilde{J}_r\}_{r \in \mathbb{R}}$ with $\tilde{J}_0 \equiv \tilde{J}$. We assume λ_r and J_r are fixed in some neighborhood of \mathcal{P} , and that X_{λ_r} is tangent to ∂M for all r . Then the moduli space \mathcal{M}_0^* embeds naturally into a connected moduli space \mathcal{M}^* consisting of pairs (r, \tilde{u}) , with \tilde{u} a \tilde{J}_r -holomorphic solution of **(BP₀)**. Recall now that all asymptotic limits are simply covered, so all solutions $\tilde{u} = (a, u) \in \mathcal{M}_r^*$ are guaranteed to be somewhere injective. There can be no $\tilde{u} = (a, u) \in \mathcal{M}_r^*$ with $\mathcal{A}_{\lambda_r}(\tilde{u}) = 0$; this would mean $u(\dot{\Sigma})$ is contained in a periodic orbit, but this is clearly not true since \tilde{u} is homotopic to some $\tilde{u}_0 \in \mathcal{M}_0^*$.

By the implicit function theorem (Thm. 4.5.44), each of the spaces \mathcal{M}_r is a smooth 2-dimensional manifold whose local structure matches that of an \mathbb{R} -invariant foliation, and from Corollary 4.5.46, \mathcal{M}^* is a smooth 3-manifold. The natural \mathbb{R} -action on \mathcal{M}^* restricts to the submanifolds $\mathcal{M}_r^* \subset \mathcal{M}^*$, and the quotients \mathcal{M}^*/\mathbb{R} and $\mathcal{M}_r^*/\mathbb{R}$ are also manifolds. There is then a smooth function $h : \mathcal{M}^*/\mathbb{R} \rightarrow \mathbb{R}$ which has no critical points and whose level sets are the 1-manifolds $\mathcal{M}_r^*/\mathbb{R}$.

Theorem 4.5.51. *Suppose that for some $r_0 > 0$, $\mathcal{M}_{[0, r_0]}^*/\mathbb{R}$ is compact. Then $\mathcal{M}_{[0, r_0]}^* \cong [0, r_0] \times \mathbb{R} \times S^1$, and for each $r \in [0, r_0]$, the moduli space \mathcal{M}_r^* constitutes a stable open book decomposition with boundary.*

Proof. It follows from Prop. 4.5.49 that $\mathcal{M}_{[0, r_0]}^* \cong [0, r_0] \times \mathbb{R} \times S^1$ and $\mathcal{M}_r^*/\mathbb{R} \cong \mathcal{M}_0^*/\mathbb{R} \cong S^1$ for each $r \in [0, r_0]$. We have to verify that \mathcal{M}_r^* defines an open book decomposition with boundary. This follows from the intersection theory in Sec. 4.4. Note that (4.5.10) gives $\text{wind}_\pi(\tilde{u}) = 0$ for any $(r, \tilde{u}) \in \mathcal{M}^*$, so if $\tilde{u} = (a, u)$, u is always immersed. Then if $[\tilde{u}_k] = [(a_k, u_k)] \in \mathcal{M}_{r_k}^*/\mathbb{R}$ with u_k embedded, $r_k \rightarrow r$ and $\tilde{u}_k \rightarrow \tilde{u} = (a, u)$ up to \mathbb{R} -translation, Theorem 4.4.4 implies that u is embedded. Likewise we deduce from Theorem 4.4.5 that for any two distinct elements $\tilde{u} = (a, u) \in \mathcal{M}_r^*$ and $\tilde{v} = (b, v) \in \mathcal{M}_r^*$, the images of u and v are either disjoint or identical.

It remains to verify that the solutions in \mathcal{M}_r^* cover all of $M \setminus \mathcal{P}$. Define

$$N_r = \{p \in M \setminus \mathcal{P} \mid p \in u(\dot{\Sigma}) \text{ for some } \tilde{u} = (a, u) \in \mathcal{M}_r^*\}.$$

By the implicit function theorem, N_r is open. The compactness of $\mathcal{M}_r^*/\mathbb{R}$ implies that N_r is also a closed subset of $M \setminus \mathcal{P}$: indeed, if $u_k(z_k) \rightarrow p \in M \setminus \mathcal{P}$ for $z_k \in \dot{\Sigma}$ and $\tilde{u}_k = (a_k, u_k) \in \mathcal{M}_r^*$, we can assume $z_k \rightarrow z_\infty \in \overline{\Sigma}$ and $\tilde{u}_k \rightarrow \tilde{u}_\infty$ in $C^0(\overline{\Sigma}, \mathbb{R} \times M)$ for some $\tilde{u}_\infty = (a_\infty, u_\infty) \in \mathcal{M}_r^*$. Thus $\tilde{u}_k(z_k) \rightarrow \tilde{u}_\infty(z_\infty) \in \overline{\mathbb{R}} \times M$. It follows that $z_\infty \in \dot{\Sigma}$ and $u(z_\infty) = p$, thus $p \in N_r$. Since N_r is open and closed and $M \setminus \mathcal{P}$ is connected, $N_r = M \setminus \mathcal{P}$, completing the proof. \square

One could also extend this result to S^1 -parametrized families with Morse-Bott asymptotic limits, and similar arguments can be used to deform more general types of finite energy foliations.

Remark 4.5.52. *An important unstated fact implicit in the above result is that if M is a proper subset of a closed contact 3-manifold M' (in our examples, $M' = S^3$), then starting with an open book decomposition \mathcal{F}_0 that foliates $M \setminus \mathcal{P}$, the deformed foliations \mathcal{F}_r always “stay inside” M . This follows easily from the fact that the leaves \tilde{u} always meet ∂M transversely, so the interior of $\dot{\Sigma}$ is mapped into $M' \setminus \partial M$.*

4.6 Energy

4.6.1 Taming functions and asymptotics

In preparation for the compactness arguments of the next chapter, we will need some *a priori* energy bounds for solutions of Problem (BP). Such bounds are possible because the boundary condition is always defined in terms of a surface $L \subset M$ which is *tangent* to X_λ , and thus $d\lambda$ vanishes on TL . The simplest consequence of this is that the contact area $\mathcal{A}_\lambda(\tilde{u})$ is a homotopy invariant. Given a solution $\tilde{u} = (a, u) : \dot{\Sigma} \rightarrow \mathbb{R} \times M$ of (BP), the *contact area* is defined as the integral

$$\mathcal{A}_\lambda(\tilde{u}) = \int_{\dot{\Sigma}} u^* d\lambda. \quad (4.6.1)$$

Observe that $\mathcal{A}_\lambda(\tilde{u})$ is always nonnegative if \tilde{u} is \tilde{J} -holomorphic. In the following, let $L \subset M$ be any surface tangent to X_λ .

Proposition 4.6.1. *Suppose $\tilde{u} = (a, u) : \dot{\Sigma} \rightarrow \mathbb{R} \times M$ and $\tilde{v} = (b, v) : \dot{\Sigma} \rightarrow \mathbb{R} \times M$ are two solutions of (BP), with the same asymptotic limits at the punctures, and such that $u|_{\partial\Sigma}$ and $v|_{\partial\Sigma}$ are homotopic maps $\partial\Sigma \rightarrow L$. Then $\mathcal{A}_\lambda(\tilde{u}) = \mathcal{A}_\lambda(\tilde{v})$.*

Proof. Let T_1, \dots, T_N be the periods of the limiting orbits at punctures $z_1, \dots, z_N \in \Gamma$. Then using the exponential approach at the punctures and Stokes’ theorem, we have

$$\mathcal{A}_\lambda(\tilde{u}) = \sum_{z_j \in \Gamma^+} T_j - \sum_{z_j \in \Gamma^-} T_j + \int_{\partial\Sigma} u^* \lambda. \quad (4.6.2)$$

The integral on the right hand side depends only on the homotopy class of $u|_{\partial\Sigma} : \partial\Sigma \rightarrow L$ since any homotopy $h : [0, 1] \times \partial\Sigma \rightarrow L$ satisfies $\int_{[0,1] \times \partial\Sigma} h^* d\lambda = 0$. \square

This bound is useful but insufficient, because $d\lambda$ is not a symplectic form on $\mathbb{R} \times M$. One usually defines a stronger notion of energy for holomorphic curves in symplectizations as follows:

$$E(\tilde{u}) = \sup_{\varphi \in \mathcal{T}_0} \int_{\tilde{\Sigma}} \tilde{u}^* d(\varphi\lambda), \quad (4.6.3)$$

where \mathcal{T}_0 is the set of all smooth functions $\varphi : \mathbb{R} \rightarrow [0, 1]$ with $\varphi' \geq 0$. In this context λ and $d\lambda$ are viewed as forms on $\mathbb{R} \times M$ and φ is a real-valued function on $\mathbb{R} \times M$ which depends only on the \mathbb{R} -coordinate. The finiteness of this energy provides a criterion for proving that solutions are asymptotically cylindrical at punctures, which is of paramount importance in compactness arguments.

An easy computation using Stokes' theorem shows that solutions of **(BP)** have finite energy as defined above. But this is not very helpful except in special cases, because the totally real submanifolds \tilde{L}_j^c are generally not Lagrangian in a conventional sense. If $\varphi : \mathbb{R} \rightarrow [0, 1]$ has positive derivative, one can define a symplectic structure on $\mathbb{R} \times M$ by $d(\varphi\lambda)$, but this form does not vanish on the graph

$$\tilde{L}_G = \{(G(x), x) \in \mathbb{R} \times M \mid x \in L\}$$

unless $G : L \rightarrow \mathbb{R}$ is constant. Without a Lagrangian boundary condition, one generally cannot obtain uniform energy bounds for solutions of Problem **(BP)**, and compactness arguments are hopeless.¹

The situation is saved by the fact that $\mathbb{R} \times M$ admits plenty of symplectic structures other than the one mentioned above. With a little care, it is perfectly possible to find a symplectic form that both tames \tilde{J} and vanishes on surfaces such as \tilde{L}_G . This leads to a generalized definition of “energy” for punctured holomorphic curves with boundary.

The generalized energy will be defined exactly as in (4.6.3), but with φ as a function on $\mathbb{R} \times M$ rather than just \mathbb{R} . The hard part is to define exactly what set of functions $\varphi : \mathbb{R} \times M \rightarrow \mathbb{R}$ should replace \mathcal{T}_0 ; in effect, this is equivalent to choosing a new class of symplectic structures on $\mathbb{R} \times M$. Most importantly, any sensible definition of energy must guarantee that solutions with finite energy have nice asymptotic behavior. We shall now present a general axiomatic framework for proving such results.

Definition 4.6.2. *An \mathbb{R} -invariant taming set \mathcal{T} is a set of smooth functions $\varphi : \mathbb{R} \times M \rightarrow [0, 1]$ satisfying the following axioms:*

¹There are situations, e.g. in [HWZ95b], where the geometry of the setup allows one to find uniform energy bounds for a totally real boundary condition that is not Lagrangian. In such cases, the energy is not a homotopy invariant, but one can prove that it only varies a finite amount due to other geometric constraints. Our situation is less fortunate.

- (POSITIVITY) $d(\varphi\lambda)(Y, \tilde{J}Y) \geq 0$ for all $\varphi \in \mathcal{T}$ and $Y \in T(\mathbb{R} \times M)$, and for any compact set $K \subset \mathbb{R} \times M$ there exists $\varphi \in \mathcal{T}$ such that $d(\varphi\lambda)(Y, \tilde{J}Y) > 0$ for all nonzero vectors $y \in T(\mathbb{R} \times M)|_K$.
- (NONTRIVIALITY) There exists a constant $C > 0$ and a function $\varphi \in \mathcal{T}$ such that for all $x \in M$, $\int_{-\infty}^{\infty} \partial_a \varphi(a, x) \geq C$.
- (REEB FLOW INVARIANCE) If $\varphi \in \mathcal{T}$ and $\Phi_\lambda^t : M \rightarrow M$ is the flow of the Reeb vector field, then the function $\varphi_t(a, x) = \varphi(a, \Phi_\lambda^t(x))$ is also in \mathcal{T} for all $t \in \mathbb{R}$.
- (\mathbb{R} -INVARIANCE) If $\varphi \in \mathcal{T}$ and $\sigma \in \mathbb{R}$, then $\varphi^\sigma(a, x) = \varphi(a + \sigma, x)$ is also in \mathcal{T} .

More generally, one can drop the \mathbb{R} -invariance axiom and define a taming set to be a set \mathcal{T} of smooth functions $\varphi : \mathbb{R} \times M \rightarrow [0, 1]$ satisfying the first three axioms, plus:

- (ASYMPTOTIC \mathbb{R} -INVARIANCE) There exist \mathbb{R} -invariant taming sets \mathcal{T}^\pm and a number $a_0 > 0$ such that for any $\varphi^\pm \in \mathcal{T}^\pm$, there are functions $\psi^\pm \in \mathcal{T}$ satisfying

$$\begin{aligned} \psi^+(a, x) &= \phi^+(a, x) && \text{for all } a > a_0, \\ \psi^-(a, x) &= \phi^-(a, x) && \text{for all } a < -a_0. \end{aligned}$$

The sets \mathcal{T}^\pm are called asymptotic taming sets for \mathcal{T} . Notice that an \mathbb{R} -invariant taming set also satisfies this last axiom by setting $\mathcal{T}^\pm = \mathcal{T}$. The functions $\varphi \in \mathcal{T}$ will be referred to as taming functions.

Note that by plugging $Y = \partial_a$ into the positivity axiom, every taming function satisfies $\partial_a \varphi \geq 0$.

Remark 4.6.3. We should say a few words about possible generalizations of this definition. None of these will be necessary for the applications we have in mind, but they could be useful in the future.

1. The Reeb flow invariance axiom is convenient for proving asymptotic results, but it may turn out to be unnecessary. This would be nice since, as we'll see in the next section, its presence is associated with a very restrictive condition on the totally real submanifolds we're allowed to use, without which the proof of the main existence result for foliations would be substantially simpler.

2. The \mathbb{R} -invariance axiom could be replaced with “discrete” \mathbb{R} -invariance: it suffices to know that $\varphi \in \mathcal{T}$ if and only if $\varphi^\sigma \in \mathcal{T}$ for some $\sigma \neq 0$. Then of course $\varphi^{N\sigma} \in \mathcal{T}$ for all $N \in \mathbb{Z}$, and the compactness arguments could be adapted to use only this assumption.
3. The notion of asymptotic \mathbb{R} -invariance can be weakened somewhat. It suffices to assume that there are numbers $a_0 > 0$ and $\kappa \in (0, 1)$ such that for each $\varphi^\pm \in \mathcal{T}^\pm$, there exist taming functions $\psi_b^\pm \in \mathcal{T}$ for $b \geq a_0$, satisfying

$$\begin{aligned}\psi_b^+(a, x) &= \phi^+(a, x) && \text{for all } a \in [b - \kappa b, b + \kappa b], \\ \psi_b^-(a, x) &= \phi^-(a, x) && \text{for all } a \in [-b - \kappa b, -b + \kappa b].\end{aligned}$$

The proofs of the asymptotic results below use only this assumption.

Given any taming set \mathcal{T} , we now define the energy of a \tilde{J} -holomorphic map $\tilde{u} : \Sigma \rightarrow \mathbb{R} \times M$ by

$$E_{\mathcal{T}}(\tilde{u}) = \sup_{\varphi \in \mathcal{T}} \int_{\Sigma} \tilde{u}^* d(\varphi \lambda).$$

The positivity condition guarantees that $E_{\mathcal{T}}(\tilde{u}) \geq 0$ for all \tilde{J} -holomorphic curves, and $E_{\mathcal{T}}(\tilde{u}) = 0$ if and only if \tilde{u} is constant.

The standard example of an \mathbb{R} -invariant taming set is the set \mathcal{T}_0 of all smooth functions $\varphi : \mathbb{R} \times M \rightarrow [0, 1]$ which depend only on the \mathbb{R} -factor and satisfy $\partial_a \varphi \geq 0$. The energy $E_{\mathcal{T}_0}(\tilde{u})$ then matches the standard definition given in (4.6.3).

We now must generalize some standard results about the asymptotic behavior of punctured holomorphic curves with finite energy.

Theorem 4.6.4. *Suppose $\tilde{u} = (a, u) : \mathring{\mathbb{D}} = \mathbb{D} \setminus \{0\} \rightarrow \mathbb{R} \times M$ is a \tilde{J} -holomorphic map with $E_{\mathcal{T}}(\tilde{u}) < \infty$. If \tilde{u} is bounded, then \tilde{u} extends to a \tilde{J} -holomorphic map $\mathbb{D} \rightarrow \mathbb{R} \times M$. Otherwise, for every sequence $s_k \rightarrow \infty$ there is a subsequence such that the loops $t \mapsto u(e^{-2\pi(s_k + it)})$ converge in $C^\infty(S^1, M)$ to a loop $t \mapsto x(Qt)$. Here $x : \mathbb{R} \rightarrow M$ is a periodic orbit of X_λ with period $T = |Q| > 0$, where*

$$Q = - \lim_{\epsilon \rightarrow 0} \int_{\partial \mathbb{D}_\epsilon} u^* \lambda$$

Moreover, $a : \mathring{\mathbb{D}} \rightarrow \mathbb{R}$ approaches either $-\infty$ or $+\infty$ at the puncture. If the orbit x is nondegenerate or Morse-Bott, then \tilde{u} is asymptotically cylindrical in the sense of Definition 1.1.9.

This theorem is a direct generalization of results from [H93], [HWZ96a] and [HWZ96b]; the only new element here is the broader definition of finite energy in

terms of arbitrary taming sets. One approach to proving this would be to redo all of the earlier work in the more general context, taking extra care with certain details where the choice of a taming set might play a role. But rather than reinventing the wheel, we shall pursue this course only far enough to prove that a \tilde{J} -holomorphic curve with $E_{\mathcal{T}}(\tilde{u}) < \infty$ has $E_{\mathcal{T}_0}(\tilde{u}) < \infty$ as well. This is possible mainly because of Prop. 4.6.6 below, which states that every finite energy plane with vanishing contact area is constant. That in itself is a direct generalization of a result from [H93], and the proof presented here is very similar. (A more detailed version of that argument may be found in [AH]).

We will repeatedly use the well known fact that “gradient bounds imply C^∞ -bounds,” i.e. in order to prove compactness in the C_{loc}^∞ -topology for a set of holomorphic curves, it suffices to find uniform C^1 -bounds over every compact subset. This follows from standard elliptic regularity estimates and the Arzelá-Ascoli theorem; see [MS04], Theorem B.4.2. Note that in the special case where the target manifold is the complex plane with its standard complex structure, the regularity estimates follow easily from the Cauchy integral formula. In the general case they are much harder.

We’ll also need the following lemma of Hofer.

Lemma 4.6.5 ([HZ94], Sec. 6.4, Lemma 5). *Let (X, d) be a complete metric space and $f : X \rightarrow [0, \infty)$ a continuous function. Then given any $x_0 \in X$ and $\epsilon_0 > 0$, there exist $x \in B_{2\epsilon_0}(x_0)$ and $\epsilon \in (0, \epsilon_0]$ such that*

$$f(x)\epsilon \geq f(x_0)\epsilon_0 \quad \text{and} \quad f(y) \leq 2f(x) \text{ for all } y \in \overline{B_\epsilon(x)}.$$

Proposition 4.6.6. *Let $\tilde{u} = (a, u) : \mathbb{C} \rightarrow \mathbb{R} \times M$ be a \tilde{J} -holomorphic map with finite energy $E_{\mathcal{T}}(\tilde{u}) < \infty$ and*

$$\int_{\mathbb{C}} u^* d\lambda = 0.$$

Then \tilde{u} is constant.

Proof. From the Cauchy-Riemann equations, using coordinates $s + it \in \mathbb{C}$,

$$d\lambda(u_s, u_t) = d\lambda(\pi_\lambda u_s, \pi_\lambda u_t) = \frac{1}{2} (d\lambda(\pi_\lambda u_s, J\pi_\lambda u_s) + d\lambda(\pi_\lambda u_t, J\pi_\lambda u_t)) \geq 0$$

thus the condition $\int_{\mathbb{C}} u^* d\lambda = 0$ implies that $\pi_\lambda \circ Tu$ vanishes identically. Then the image of $du(s, t)$ is contained in $\mathbb{R}X_\lambda(u(s, t)) \subset T_{u(s, t)}M$, so

$$u_s = \lambda(u_s)X_\lambda(u) \quad \text{and} \quad u_t = \lambda(u_t)X_\lambda(u).$$

In fact, since \mathbb{C} is contractible, we can construct a (not necessarily periodic) Reeb orbit $x : \mathbb{R} \rightarrow M$ and a smooth function $f : \mathbb{C} \rightarrow \mathbb{R}$ such that $u(s, t) = x(f(s, t))$.

We claim that the function $\Phi = a + if : \mathbb{C} \rightarrow \mathbb{C}$ is holomorphic (in the classical sense). Indeed,

$$\begin{aligned} a_s &= \lambda(u_t) = \lambda(\dot{x}(f)f_t) = f_t \lambda(X_\lambda(x(f))) = f_t, \\ a_t &= -\lambda(u_s) = -\lambda(\dot{x}(f)f_s) = -f_s \lambda(X_\lambda(x(f))) = -f_s. \end{aligned}$$

For any $\varphi \in \mathcal{T}$, define $\psi : \mathbb{C} \rightarrow \mathbb{R}$ by $\psi(s, t) = \varphi(s, x(t))$, and define a 2-form on \mathbb{C} by

$$\tau_\varphi = d(\psi(s, t)dt) = \partial_s \varphi(s, x(t)) ds \wedge dt.$$

Observe that this form is nonnegative with respect to the natural orientation of \mathbb{C} , and for any holomorphic function $F : \mathbb{C} \rightarrow \mathbb{C}$, the same is true of $F^* \tau_\varphi$. We can use this to define a notion of energy for the entire function Φ which coincides with $E_{\mathcal{T}}(\tilde{u})$; indeed,

$$\begin{aligned} \int_{\mathbb{C}} \tilde{u}^* d(\varphi \lambda) &= \int_{\mathbb{C}} (d\varphi \wedge \lambda)(a_s \partial_a + \lambda(u_s) X_\lambda(u), a_t \partial_a + \lambda(u_t) X_\lambda(u)) ds \wedge dt \\ &= \int_{\mathbb{C}} \partial_a \varphi(\tilde{u}) (a_s f_t - a_t f_s) ds \wedge dt \\ &= \int_{\mathbb{C}} \partial_a \varphi(a, x \circ f) da \wedge df = \int_{\mathbb{C}} \Phi^* \tau_\varphi. \end{aligned} \tag{4.6.4}$$

The map \tilde{u} is constant if and only if Φ is constant. If Φ is non-constant and has a bounded first derivative, then Liouville's theorem implies that Φ is an affine map $\Phi(z) = Az + B$ for $A, B \in \mathbb{C}$ with $A \neq 0$. Thus Φ is an orientation preserving diffeomorphism of \mathbb{C} , and

$$\int_{\mathbb{C}} \Phi^* \tau_\varphi = \int_{\Phi(\mathbb{C})} \tau_\varphi = \int_{\mathbb{C}} \tau_\varphi = \int_{\mathbb{C}} \partial_s \varphi(s, x(t)) ds dt.$$

By the nontriviality axiom, we can choose $\varphi \in \mathcal{T}$ such that this integral is infinite. Thus if Φ is non-constant with finite energy, its first derivative must be unbounded. We will now show by a simple bubbling off argument that this also cannot happen.

Assume $z_k \in \mathbb{C}$ such that $R_k := |\nabla \Phi(z_k)| \rightarrow \infty$, and choose a sequence $\epsilon_k \rightarrow 0$ with $\epsilon_k R_k \rightarrow \infty$. Using Lemma 4.6.5, we may assume without loss of generality that $|\nabla \Phi(z)| \leq 2|\nabla \Phi(z_k)|$ for all $z \in \overline{B_{\epsilon_k}(z_k)}$. Denote $a_k + if_k = \Phi(z_k)$. We must distinguish two possible cases.

Case 1: assume there is a subsequence for which a_k is bounded. Define a sequence of rescaled maps $\Phi_k : \mathbb{C} \rightarrow \mathbb{C}$ by

$$\Phi_k(z) = \Phi \left(z_k + \frac{z}{R_k} \right) - if_k.$$

These are all holomorphic functions, with $\Phi_k(0) = a_k$, $|\nabla\Phi_k(0)| = 1$ and

$$|\nabla\Phi_k(z)| \leq 2 \quad \text{for all } z \in \mathbb{D}_{\epsilon_k R_k}.$$

This gradient bound together with the Cauchy integral formula now implies C^∞ -bounds for Φ_k on every compact subset of \mathbb{C} , thus applying Arzelá-Ascoli, we can pass to a subsequence and assume that Φ_k converges in $C_{\text{loc}}^\infty(\mathbb{C}, \mathbb{C})$ to a holomorphic function $\Phi_\infty : \mathbb{C} \rightarrow \mathbb{C}$. From the properties of Φ_k , we deduce

$$|\nabla\Phi_\infty(0)| = 1, \quad \text{and} \quad |\nabla\Phi_\infty(z)| \leq 2 \quad \text{for all } z \in \mathbb{C}$$

Thus Φ_∞ is a non-constant affine function. Write $\psi_k(z) = z_k + z/R_k$ and $F_k(z) = z - if_k$, so $\Phi_k = F_k \circ \Phi \circ \psi_k$. Using the nontriviality axiom again, there is a taming function $\varphi \in \mathcal{T}$ such that

$$\int_{\mathbb{C}} \Phi_\infty^* \tau_\varphi = \int_{\mathbb{C}} \tau_\varphi = \infty.$$

On the other hand, for any disk $\mathbb{D}_r \subset \mathbb{C}$, we have

$$\begin{aligned} \int_{\mathbb{D}_r} \Phi_\infty^* \tau_\varphi &= \lim_{k \rightarrow \infty} \int_{\mathbb{D}_r} \Phi_k^* \tau_\varphi \leq \lim_{k \rightarrow \infty} \int_{\mathbb{D}_{\epsilon_k R_k}} \Phi_k^* \tau_\varphi \\ &= \lim_{k \rightarrow \infty} \int_{\mathbb{D}_{\epsilon_k R_k}} \psi_k^* \Phi^* F_k^* \tau_\varphi = \lim_{k \rightarrow \infty} \int_{B_{\epsilon_k}(z_k)} \Phi^* \tau_k \leq \sup_k \int_{\mathbb{C}} \Phi^* \tau_k \end{aligned}$$

where $\tau_k = \partial_s \varphi(s, x(t - f_k)) ds \wedge dt$. This can be rewritten as $\tau_k = \partial_s \varphi_k(s, x(t)) ds \wedge dt$ where $\varphi_k(a, x) = \varphi(a, \Phi_{X_\lambda}^{-f_k}(x))$, thus $\varphi_k \in \mathcal{T}$ by Reeb flow invariance, and we conclude

$$\infty = \lim_{r \rightarrow \infty} \int_{\mathbb{D}_r} \Phi_\infty^* \tau_\varphi \leq E_{\mathcal{T}}(\tilde{u}),$$

contradicting the finite energy assumption.

Case 2: assume $|a_k| \rightarrow \infty$. We can take a subsequence so that a_k converges to either $+\infty$ or $-\infty$; assume it's the former (an analogous argument works when a_k is negative). We now rescale as follows,

$$\Phi_k(z) = \Phi\left(z_k + \frac{z}{R_k}\right) - (a_k + if_k).$$

Now $\Phi_k(0) = 0$, and by the same arguments as in the first case, a subsequence of Φ_k converges in $C_{\text{loc}}^\infty(\mathbb{C}, \mathbb{C})$ to a non-constant affine function $\Phi_\infty : \mathbb{C} \rightarrow \mathbb{C}$. Write $\psi_k(z) = z_k + z/R_k$ and $F_k(z) = z - (a_k + if_k)$, so $\Phi_k = F_k \circ \Phi \circ \psi_k$. This time we

shall use the asymptotic \mathbb{R} -invariance axiom to prove that $E_{\mathcal{T}}(\tilde{u})$ cannot be finite. Choose $\varphi^+ \in \mathcal{T}^+$ with

$$\int_{\mathbb{C}} \Phi_{\infty}^* \tau_{\varphi^+} = \int_{\mathbb{C}} \tau_{\varphi^+} = \infty.$$

For sufficiently large k , there are taming functions $\varphi_k \in \mathcal{T}$ and a number $\kappa \in (0, 1)$ such that

$$\varphi_k(a, x) = \varphi^+(a - a_k, x) \quad \text{for all } a \in [a_k - \kappa a_k, a_k + \kappa a_k].$$

Let $r_k = \min\{\epsilon_k R_k, \kappa a_k/2\}$. Then we have $r_k \rightarrow \infty$, and using the uniform gradient bound for Φ_k , $|\Phi_k(z)| \leq 2r_k \leq \kappa a_k$ for all $z \in \mathbb{D}_{r_k}$, which implies

$$|a(z) - a_k| \leq \kappa a_k \quad \text{for all } z \in \psi_k(\mathbb{D}_{r_k}) \subset \overline{B_{\epsilon_k}(z_k)}.$$

Thus for any disk $\mathbb{D}_r \subset \mathbb{C}$,

$$\begin{aligned} \int_{\mathbb{D}_r} \Phi_{\infty}^* \tau_{\varphi^+} &= \lim_{k \rightarrow \infty} \int_{\mathbb{D}_r} \Phi_k^* \tau_{\varphi^+} \leq \lim_{k \rightarrow \infty} \int_{\mathbb{D}_{r_k}} \Phi_k^* \tau_{\varphi^+} \\ &= \lim_{k \rightarrow \infty} \int_{\mathbb{D}_{r_k}} \psi_k^* \Phi_k^* F_k^* \tau_{\varphi^+} = \lim_{k \rightarrow \infty} \int_{\psi_k(\mathbb{D}_{r_k})} \Phi^* \tau_k \leq \sup_k \int_{\mathbb{C}} \Phi^* \tau_k \end{aligned}$$

where $\tau_k = \partial_s \varphi(s - a_k, x(t - f_k)) ds \wedge dt$ on a neighborhood of $\Phi(\psi_k(\mathbb{D}_{r_k}))$. Replacing this with $\partial_s \tilde{\varphi}_k(s, x(t)) ds \wedge dt$, where $\tilde{\varphi}_k(a, x) = \varphi_k(a, \Phi_{X_{\lambda}}^{-f_k}(x))$, we have $\tilde{\varphi}_k \in \mathcal{T}$, and thus $E_{\mathcal{T}}(\tilde{u}) = \infty$.

The only remaining alternative is that Φ is constant, and thus so is \tilde{u} . \square

Proof of Theorem 4.6.4. If $\tilde{u}(\mathbb{D})$ is contained in a compact set $K \subset \mathbb{R} \times M$, the positivity axiom provides a taming function $\varphi \in \mathcal{T}$ such that $d(\varphi\lambda)$ is a symplectic form on a neighborhood of K , and

$$\int_{\mathbb{D}} \tilde{u}^* d(\varphi\lambda) < E_{\mathcal{T}}(\tilde{u}) < \infty.$$

Thus \tilde{u} extends over \mathbb{D} by Gromov's removable singularity theorem.

Assume now that \tilde{u} is unbounded. We use the biholomorphic map $\psi : [0, \infty) \times S^1 \rightarrow \mathbb{D} : (s, t) \mapsto e^{-2\pi(s+it)}$ to replace \tilde{u} with

$$\tilde{v} = (b, v) = \tilde{u} \circ \psi : [0, \infty) \times S^1 \rightarrow \mathbb{R} \times M.$$

Our goal will be to show that there is a sequence $s_k \rightarrow \infty$ for which the loops $t \mapsto v(s_k, t)$ converge in $C^{\infty}(S^1, M)$ to a closed Reeb orbit $t \mapsto x(Qt)$, where

$$Q = \lim_{k \rightarrow \infty} \int_{\{s_k\} \times S^1} v^* \lambda \in \mathbb{R} \setminus \{0\}.$$

The theorem then follows by showing that the standard energy $E_{\mathcal{T}_0}(\tilde{v})$ is finite, so the results from [H93], [HWZ96a] and [HWZ96b] can be applied. There's a larger principle at work here: *the finite energy condition does not depend on the choice of taming set*. Indeed, given another taming set \mathcal{T}' and a function $\varphi \in \mathcal{T}'$, the positivity axiom implies that the function

$$s \mapsto \int_{[0,s] \times S^1} \tilde{v}^* d(\varphi\lambda)$$

is continuous and nondecreasing, thus its limit as $s \rightarrow \infty$ is well defined in $[0, \infty]$. We can therefore use the sequence s_k to compute it, and applying Stokes' theorem, together with the C^∞ -convergence of $v(s_k, t)$ to $x(Qt)$ and the fact that $\varphi \leq 1$,

$$\begin{aligned} \left| \int_{[0,\infty) \times S^1} \tilde{v}^* d(\varphi\lambda) \right| &= \left| - \int_{\{0\} \times S^1} \tilde{v}^*(\varphi\lambda) + \lim_{k \rightarrow \infty} \int_{\{s_k\} \times S^1} \tilde{v}^*(\varphi\lambda) \right| \\ &\leq \int_{\{0\} \times S^1} |v^*\lambda| + \lim_{k \rightarrow \infty} \int_{\{s_k\} \times S^1} |v^*\lambda| \\ &\leq \int_{\{0\} \times S^1} |v^*\lambda| + |Q|. \end{aligned}$$

Note also that by a similar argument using Stokes' theorem and the positivity of $v^*d\lambda$, the limit

$$\lim_{s \rightarrow \infty} \int_{\{s\} \times S^1} v^*\lambda$$

exists in $(-\infty, \infty]$, and equals the limit of the integrals over $\{s_k\} \times S^1$ as $k \rightarrow \infty$. It will therefore suffice to examine the behavior of $v(s_k, t)$ for a particular sequence $s_k \rightarrow \infty$.

We claim first that $|\nabla\tilde{v}|$ is bounded on $[0, \infty) \times S^1$. Otherwise, there is a sequence $z_k = (\sigma_k, \tau_k) \in [0, \infty) \times S^1$ such that $\sigma_k \rightarrow \infty$ and $R_k := |\nabla\tilde{v}(z_k)| \rightarrow \infty$. We choose also a sequence $\epsilon_k \rightarrow 0$ with $\epsilon_k R_k \rightarrow \infty$, and using Lemma 4.6.5, we can assume

$$|\nabla\tilde{v}(z)| \leq 2|\nabla\tilde{v}(z_k)| \quad \text{for all } z \in \overline{B_{\epsilon_k}(z_k)}.$$

Identifying $[0, \infty) \times S^1$ with $\mathbb{H}_R/i\mathbb{Z}$ where $\mathbb{H}_R \subset \mathbb{C}$ is the closed right half-plane, define $\psi_k : \mathbb{C} \rightarrow \mathbb{R} \times S^1$ by

$$\psi_k(z) = z_k + \frac{z}{R_k}.$$

For sufficiently large k these give embeddings $\mathbb{D}_{\epsilon_k R_k} \hookrightarrow [0, \infty) \times S^1$. As in the proof of Prop. 4.6.6, there are two cases to consider.

If there is a subsequence for which $b(z_k)$ is bounded, we define a sequence of rescaled maps $\tilde{v}_k = (b_k, v_k) : \mathbb{D}_{\epsilon_k R_k} \rightarrow \mathbb{R} \times M$ by

$$\tilde{v}_k(z) = \tilde{v} \circ \psi_k(z).$$

The points $\tilde{v}_k(z_k)$ are contained in a compact subset of $\mathbb{R} \times M$, and there is a uniform gradient bound $|\nabla \tilde{v}_k(z)| \leq 2$ for all $z \in \mathbb{D}_{\epsilon_k R_k}$. Thus a subsequence of \tilde{v}_k converges to a \tilde{J} -holomorphic plane $\tilde{v}_\infty : \mathbb{C} \rightarrow \mathbb{R} \times M$, which is non-constant since $|\nabla \tilde{v}_k(0)| = 1$. It also has finite energy $E_{\mathcal{T}}(\tilde{v}_\infty)$, since for any $\varphi \in \mathcal{T}$,

$$\int_{\mathbb{D}_{\epsilon_k R_k}} \tilde{v}_k^* d(\varphi \lambda) = \int_{B_{\epsilon_k}(z_k)} \tilde{v}^* d(\varphi \lambda) \leq \int_{[0, \infty) \times S^1} \tilde{v}^* d(\varphi \lambda) \leq E_{\mathcal{T}}(\tilde{v}).$$

Moreover,

$$\int_{\mathbb{D}_{\epsilon_k R_k}} v_k^* d\lambda = \int_{B_{\epsilon_k}(z_k)} v^* d\lambda \rightarrow 0 \quad \text{as } k \rightarrow \infty,$$

thus $\int_{\mathbb{C}} v_\infty^* d\lambda = 0$. Prop. 4.6.6 then implies that \tilde{v}_∞ is constant, yielding a contradiction.

The other possibility is that $|b(z_k)| \rightarrow \infty$, in which case we define

$$\tilde{v}_k(z) = (b_k(z), v_k(z)) = (b \circ \psi_k(z) - b(z_k), v \circ \psi_k(z)).$$

Now $b_k(z_k) = 0$, so the points $\tilde{v}_k(z_k)$ are still contained in a compact subset of $\mathbb{R} \times M$, and as before there is a subsequence converging to a non-constant \tilde{J} -holomorphic plane $\tilde{v}_\infty : \mathbb{C} \rightarrow \mathbb{R} \times M$. We have

$$\int_{\mathbb{C}} v_\infty^* d\lambda = 0$$

by the same argument as above. To prove that the energy is finite, let $r_k = \min\{\epsilon_k R_k, \kappa|b(z_k)|/2\}$, so $r_k \rightarrow \infty$, and using the fact that $|\nabla \tilde{v}_k(z)| \leq 2$ for all $z \in \mathbb{D}_{\epsilon_k R_k}$, we have $|b(z) - b(z_k)| \leq \kappa|b(z_k)|$ for all $z \in \psi_k(\mathbb{D}_{r_k})$. Passing to a subsequence, we may assume $b(z_k) \rightarrow +\infty$ or $-\infty$; assume the former. Then for any $\varphi^+ \in \mathcal{T}^+$ and sufficiently large k , we can choose $\varphi_k \in \mathcal{T}$ such that

$$\varphi_k(b, x) = \varphi^+(b - b(z_k), x) \quad \text{for all } b \in [b(z_k) - \kappa b(z_k), b(z_k) + \kappa b(z_k)].$$

Then

$$\int_{\mathbb{D}_{r_k}} \tilde{v}_k^* d(\varphi^+ \lambda) = \int_{\psi_k(\mathbb{D}_{r_k})} \tilde{v}^* d(\varphi_k \lambda) \leq \int_{[0, \infty) \times S^1} \tilde{v}^* d(\varphi_k \lambda) \leq E_{\mathcal{T}}(\tilde{v}).$$

This proves $E_{\mathcal{T}^+}(\tilde{v}_\infty) < \infty$, and a contradiction follows again from Prop. 4.6.6. In the case where $b(z_k) \rightarrow -\infty$, we prove similarly that $E_{\mathcal{T}^-}(\tilde{v}_\infty) < \infty$, with the same result. This proves the claim that $|\nabla\tilde{v}|$ is bounded.

Now pick any sequence $s_k \rightarrow \infty$ such that $b(s_k, t)$ is unbounded, and define translated maps $\tilde{v}_k = (b_k, v_k) : [-s_k, \infty) \times S^1 \rightarrow \mathbb{R} \times M$ by

$$(b_k(s, t), v_k(s, t)) = (b(s + s_k, t) - b(s_k, 0), v(s + s_k, t)).$$

Then there is a uniform gradient bound for \tilde{v}_k , and the points $\tilde{v}_k(0, 0)$ are contained in a compact subset of $\mathbb{R} \times M$. Passing to a subsequence, \tilde{v}_k converges in $C_{\text{loc}}^\infty(\mathbb{R} \times S^1, \mathbb{R} \times M)$ to a \tilde{J} -holomorphic cylinder $\tilde{v}_\infty = (b_\infty, v_\infty) : \mathbb{R} \times S^1 \rightarrow \mathbb{R} \times M$ with bounded gradient $|\nabla\tilde{v}_\infty|$. We have

$$\int_{[-s_k/2, \infty) \times S^1} v_k^* d\lambda = \int_{[s_k/2, \infty) \times S^1} v^* d\lambda \rightarrow 0 \quad \text{as } k \rightarrow \infty,$$

thus $\int_{\mathbb{R} \times S^1} v_\infty^* d\lambda = 0$. We can think of \tilde{v}_∞ as a map $\mathbb{C} \rightarrow \mathbb{R} \times M$ which is periodic in t ; then arguing as in the proof of Prop. 4.6.6, the vanishing contact area allows us to find a Reeb orbit $x : \mathbb{R} \rightarrow M$ and a holomorphic function $\Phi_\infty = b_\infty + if_\infty : \mathbb{C} \rightarrow \mathbb{C}$ such that $\tilde{v}_\infty(s, t) = (b_\infty(s, t), x(f_\infty(s, t)))$. By construction, $b_\infty(0, 0) = \lim_k b_k(0, 0) = 0$, moreover x and f_∞ can be chosen so that $f_\infty(0, 0) = 0$ (this determines both uniquely). The global bound on $|\nabla\tilde{v}_\infty|$ yields a global bound on Φ_∞ , thus by Liouville's theorem, the latter is an affine function $\Phi_\infty(z) = Az + B$. We conclude $B = 0$ since $\Phi_\infty(0) = 0$, then writing $A = \alpha + \beta i$ and comparing $(\alpha + \beta i)z$ with $b_\infty(z) + if_\infty(z)$ yields

$$\begin{aligned} b_\infty(s, t) &= \alpha s - \beta t, \\ f_\infty(s, t) &= \beta s + \alpha t. \end{aligned}$$

The function $b_\infty(s, t)$ must also be 1-periodic in t , thus $\beta = 0$, so we have

$$(b_\infty(s, t), v_\infty(s, t)) = (\alpha s, x(\alpha t)).$$

The constant α can be found by integrating

$$Q = \lim_{k \rightarrow \infty} \int_{\{s_k\} \times S^1} v^* \lambda = \lim_{k \rightarrow \infty} \int_{\{0\} \times S^1} v_k^* \lambda = \int_{\{0\} \times S^1} v_\infty^* \lambda = \alpha.$$

It remains to prove $Q \neq 0$. Assume the contrary: then $v(s_k, \cdot)$ converges in $C^\infty(S^1, M)$ to a constant $x(0) \in M$. We now use the assumption that $b(s_k, t)$ is unbounded to derive a contradiction to Gromov's monotonicity lemma (see Prop. 4.6.7

below). The idea is that if \tilde{v} is unbounded and v is asymptotically constant, the image of \tilde{v} must contain cylindrical segments of arbitrarily small area. Suppose first that $b(s_k, t)$ is not bounded from above. Then for any $c > 0$, we can choose numbers r and r' such that both are regular values for $b : [0, \infty) \times S^1 \rightarrow \mathbb{R}$, r is arbitrarily large and $r' \in [r + c, r + 2c]$. Since $b(s_k, t) - b(s_k, 0)$ converges uniformly to 0, there is a subsequence such that $b(s_k, t)$ lies outside of any compact interval for sufficiently large k . Thus $b^{-1}(r)$ and $b^{-1}(r')$ are each countable unions of disjoint circles in $[0, \infty) \times S^1$, which we may assume without loss of generality are nonempty; in fact, $b^{-1}([r, r'])$ contains a compact annulus Ω_r with $\partial\Omega_r$ consisting of two circles γ^- and γ^+ such that $\gamma^- \subset b^{-1}(r)$ and $\gamma^+ \subset b^{-1}(r')$. We can also assume

$$\Omega_r \subset [s_r, \infty) \times S^1$$

for some $s_r > 0$ with $s_r \rightarrow \infty$ as $r \rightarrow \infty$. Consider now the translated maps

$$\tilde{v}_r = (b - r, v) : [0, \infty) \times S^1 \rightarrow \mathbb{R} \times M$$

which take Ω_r into $[0, 2c] \times M$ and $\partial\Omega_r$ into the complement of $(0, c) \times M$. Choose any function $\psi : \mathbb{R} \rightarrow [0, 1]$ which satisfies $\psi > 0$ and $\psi' > 0$; then the symplectic form $d(\psi\lambda)$ is compatible with \tilde{J} , and we compute

$$\begin{aligned} \int_{\Omega_r} \tilde{v}_r^* d(\psi\lambda) &\leq \int_{[s_r, \infty) \times S^1} \tilde{v}_r^* d(\psi\lambda) \\ &= \lim_{s \rightarrow \infty} \int_{\{s\} \times S^1} \tilde{v}_r^*(\psi\lambda) - \int_{\{s_r\} \times S^1} \tilde{v}_r^*(\psi\lambda) \leq \int_{\{s_r\} \times S^1} |v^*\lambda| \rightarrow 0 \end{aligned}$$

as $r \rightarrow \infty$, using the assumption $Q = 0$. Clearly then, we can pick a small number ϵ and a sequence of ϵ -balls B_r around points in $\tilde{v}_r(\Omega_r) \cap (\{c/2\} \times M)$, such that $\tilde{v}_r(\partial\Omega_r) \cap B_r = \emptyset$ and the area of $\tilde{v}_r(\Omega_r) \cap B_r$ becomes arbitrarily small as r is increased, yielding a contradiction. A similar argument works in the case where $b(s_k, t)$ is bounded from above but not from below.

Having shown that $Q \neq 0$, x is therefore a nontrivial periodic orbit, with period $T = |Q|$. \square

For the sake of completeness, we include here the monotonicity lemma; see [Hm97] for a proof.

Lemma 4.6.7 (Monotonicity). *For any compact almost complex manifold (W, J) with Hermitian metric g , there are constants ϵ_0 and $C > 0$ such that the following holds. Assume (S, j) is a compact Riemann surface, possibly with boundary, and $u : S \rightarrow W$ is a pseudoholomorphic curve. Then for every $z \in \text{int } S$ and $r \in (0, \epsilon_0)$ such that $u(\partial S) \cap B_r(u(z)) = \emptyset$,*

$$\text{Area}(u(S) \cap B_r(u(z))) \geq Cr^2.$$

An important special case is when J is tamed by a symplectic form ω and the Hermitian metric is $g_J(X, Y) = \frac{1}{2}[\omega(X, JY) + \omega(Y, JX)]$. Then

$$\text{Area}(u(S) \cap B_r(u(z))) = \int_{u^{-1}(B_r(u(z)))} u^* \omega.$$

Remark 4.6.8. *It's worth repeating that for any two taming sets \mathcal{T} and \mathcal{T}' , $E_{\mathcal{T}}(\tilde{u})$ is finite if and only if $E_{\mathcal{T}'}(\tilde{u})$ is. One would like to go further and say that given a sequence of \tilde{J} -holomorphic curves \tilde{u}_k , $E_{\mathcal{T}}(\tilde{u}_k)$ satisfies a uniform bound if and only if $E_{\mathcal{T}'}(\tilde{u}_k)$ does. We will not attempt to prove such a general result here, but heuristically it should follow from a compactness argument: a bound on $E_{\mathcal{T}}(\tilde{u}_k)$ implies some form of compactness for \tilde{u}_k , which implies a bound on $E_{\mathcal{T}'}(\tilde{u}_k)$.*

So far we have seen only one example of a taming set, consisting of functions $\varphi(a, x)$ that don't depend on x . In this case the axioms are trivial to verify. But the advantage of this formalism is that we can now use taming functions that vary on the slices $\{a\} \times M$. First we need a convenient criterion for the positivity axiom.

Proposition 4.6.9. *Let $\varphi : \mathbb{R} \times M \rightarrow [0, 1]$ be a smooth function satisfying*

$$|d\varphi(v)|^2 \leq 4\varphi \cdot (\partial_a \varphi) \cdot d\lambda(v, Jv) \quad \text{for all } v \in \xi. \quad (4.6.5)$$

Then \tilde{J} is tamed by the 2-form $d(\varphi\lambda)$, in the sense that for every $Y \in T(\mathbb{R} \times M)$, $d(\varphi\lambda)(Y, \tilde{J}Y) \geq 0$.

Proof. Denote $|v|_J^2 = d\lambda(v, Jv)$ for any $v \in \xi$. Using the splitting $T(\mathbb{R} \times M) = \mathbb{R} \oplus \mathbb{R}X_\lambda \oplus \xi$, let $Y = c_1\partial_a + c_2X_\lambda + v$, where c_1 and c_2 are real numbers and $v \in \xi$. Then $\tilde{J}Y = -c_2\partial_a + c_1X_\lambda + Jv$. We compute,

$$\begin{aligned} d(\varphi\lambda)(Y, \tilde{J}Y) &= \varphi d\lambda(v, Jv) + (d\varphi \wedge \lambda)(Y, \tilde{J}Y) \\ &= \varphi|v|_J^2 + d\varphi(c_1\partial_a + c_2X_\lambda + v)c_1 - d\varphi(-c_2\partial_a + c_1X_\lambda + Jv)c_2 \\ &= \varphi|v|_J^2 + \partial_a\varphi(c_1^2 + c_2^2) + d\varphi(c_1v - c_2Jv). \end{aligned}$$

Note that the assumption (4.6.5) implies $\partial_a\varphi \geq 0$, and we have

$$|d\varphi(c_1v - c_2Jv)| \leq 2\sqrt{\varphi(\partial_a\varphi)}|c_1v - c_2Jv|_J = 2\sqrt{\varphi(\partial_a\varphi)(c_1^2 + c_2^2)}|v|_J.$$

Thus

$$\begin{aligned} d(\varphi\lambda)(Y, \tilde{J}Y) &= \varphi|v|_J^2 + \partial_a\varphi(c_1^2 + c_2^2) + d\varphi(c_1v - c_2Jv) \\ &\geq \varphi|v|_J^2 + \partial_a\varphi(c_1^2 + c_2^2) - 2\sqrt{\varphi(\partial_a\varphi)(c_1^2 + c_2^2)}|v|_J \\ &= \left(\sqrt{\varphi}|v|_J - \sqrt{\partial_a\varphi(c_1^2 + c_2^2)} \right)^2 \geq 0. \end{aligned}$$

□

Remark 4.6.10. *A similar argument shows that if φ satisfies a stricter bound such as*

$$|d\varphi(v)|^2 \leq \varphi \cdot (\partial_a \varphi) \cdot d\lambda(v, Jv) \quad \text{for all } v \in \xi,$$

then $d(\varphi\lambda)$ is actually symplectic and $d(\varphi\lambda)(Y, \tilde{J}Y) > 0$ for all nonzero vectors $Y \in T(\mathbb{R} \times M)$.

4.6.2 Pseudo-Lagrangian tori and energy bounds

We now consider Problem **(BP)** with boundary conditions defined by a set of pairwise disjoint tori $L_1, \dots, L_N \subset M$, each tangent to X_λ . As before, we choose families of smooth functions $G_j^\sigma : L_j \rightarrow \mathbb{R}$, for $\sigma \in \mathbb{R}$, such that $\frac{\partial}{\partial \sigma} G_j^\sigma > 0$ and define the totally real submanifolds $\tilde{L}_j^\sigma \subset \mathbb{R} \times M$ as the graphs

$$\tilde{L}_j^\sigma = \{(G_j^\sigma(x), x) \in \mathbb{R} \times M \mid x \in L_j\}$$

for any $\sigma \in \mathbb{R}$. We will assume that these families of tori are either \mathbb{R} -invariant or *asymptotically flat*; the latter means that the functions G_j^σ are constant for all σ outside of some finite interval. For purely technical reasons, we need one additional assumption:

Definition 4.6.11. *The torus $\tilde{L}_j^\sigma \subset \mathbb{R} \times M$ is called pseudo-Lagrangian if it is everywhere tangent to X_λ .*

This condition means that $dG_j^\sigma(X_\lambda) \equiv 0$. We require solutions $\tilde{u} = (a, u) : \dot{\Sigma} \rightarrow \mathbb{R} \times M$ of **(BP)** at each component $\gamma \subset \partial\Sigma$ to satisfy the boundary condition $\tilde{u}(\gamma) \subset \tilde{L}_j^\sigma$ for some $\sigma \in \mathbb{R}$ and $j \in \{1, \dots, N\}$.

The main purpose of the pseudo-Lagrangian condition is that it allows us to define a taming set for which the resulting notion of energy satisfies a uniform bound.

Definition 4.6.12. *We say that a taming set \mathcal{T} is compatible with the tori \tilde{L}_j^σ if every function $\varphi \in \mathcal{T}$ is constant on each torus \tilde{L}_j^σ .*

We see from this why the pseudo-Lagrangian condition is needed: unless X_λ is tangent to \tilde{L}_j^σ , there can usually be no compatible set of functions satisfying the Reeb flow invariance axiom.

Remark 4.6.13. *As mentioned earlier, it may be possible to remove the Reeb flow invariance axiom without sacrificing the useful properties of taming sets. Unfortunately, it is not clear whether this completely eliminates the need for the pseudo-Lagrangian condition, as we will also use it in the next two sections to facilitate bubbling off arguments near the boundary.*

For an easy example of a compatible taming set, one can use the standard set \mathcal{T}_0 when the boundary conditions take the form $\tilde{L}_j^\sigma = \{\sigma\} \times L_j$. In more general cases it is not immediately obvious whether compatible taming sets exist, so we prove this next.

In particular, given any \mathbb{R} -invariant or asymptotically flat family of pseudo-Lagrangian tori \tilde{L}_j^σ , let \mathcal{T}_L be the set of smooth functions $\varphi : \mathbb{R} \times M \rightarrow [0, 1]$ such that

- (i) φ satisfies the taming criterion (4.6.5), and
- (ii) φ is constant on each torus \tilde{L}_j^σ .

Proposition 4.6.14. \mathcal{T}_L is a taming set.

Proof. We verify the nontriviality axiom first. The claim is that there exists a smooth function $\varphi : \mathbb{R} \times M \rightarrow [0, 1]$ which is constant on \tilde{L}_j^σ , satisfies the taming criterion

$$|d\varphi(v)|^2 \leq 4\varphi \cdot (\partial_a \varphi) \cdot d\lambda(v, Jv) \quad \text{for all } v \in \xi,$$

as well as

$$\lim_{a \rightarrow -\infty} \varphi(a, x) = 0 \quad \text{and} \quad \lim_{a \rightarrow \infty} \varphi(a, x) = 1$$

for all $x \in M$. To simplify the notation, for any function $g : \mathbb{R} \times M \rightarrow \mathbb{R}$ and any point $(a, x) \in \mathbb{R} \times M$ we will write

$$|dg(a, x)|_\xi := \sup_{v \in \xi_x \setminus \{0\}} \frac{|dg(a, x)v|}{|v|_J} \quad \text{where} \quad |v|_J^2 = d\lambda(v, Jv).$$

Since the surfaces \tilde{L}_j^σ are never tangent to ∂_a , we can find a smooth function $\psi : \mathbb{R} \times M \rightarrow \mathbb{R}$ which is constant on each torus \tilde{L}_j^σ and has $\partial_a \psi > 0$. Recall that the families $\{\tilde{L}_j^\sigma\}_\sigma$ are asymptotically flat, so we can also require that $\partial_a \psi \equiv 1$ outside of some compact set in $\mathbb{R} \times M$. Then $\partial_a \psi$ is globally bounded away from 0, and $|d\psi|_\xi$ is bounded from above. Choose a diffeomorphism $f : \mathbb{R} \rightarrow (0, 1)$ such that $f' > 0$ and f'/f is bounded. (Near $-\infty$ one can accomplish this by setting $f(t) = e^t$.) Now define $\varphi : \mathbb{R} \times M \rightarrow (0, 1)$ by $\varphi(a, x) = f(r\psi(a, x))$, where $r > 0$ is a scaling factor, to be determined momentarily. This function clearly is constant on the tori \tilde{L}_j^σ and has the right behavior as $a \rightarrow \pm\infty$. To verify the taming criterion, we compute

$$|d\varphi(a, x)|_\xi^2 = r^2 |f'(r\psi(a, x))|^2 |d\psi(a, x)|_\xi^2$$

and

$$\partial_a \varphi(a, x) = r f'(r\psi(a, x)) \partial_a \psi(a, x),$$

thus

$$\begin{aligned}
\frac{|d\varphi(a, x)|_\xi^2}{\varphi(a, x) \cdot \partial_a \varphi(a, x)} &= \frac{r^2 |f'(r\psi(a, x))|^2 |d\psi(a, x)|_\xi^2}{r f(r\psi(a, x)) f'(r\psi(a, x)) \partial_a \psi(a, x)} \\
&= r \frac{f'(r\psi(a, x))}{f(r\psi(a, x))} \frac{|d\psi(a, x)|_\xi^2}{\partial_a \psi(a, x)} \\
&\leq r \cdot \sup \frac{f'}{f} \cdot \sup \frac{|d\psi|_\xi^2}{\partial_a \psi}.
\end{aligned}$$

This is bounded below 4 if r is chosen sufficiently small. We've proved the nontriviality axiom; in fact, combining this with Prop. 4.6.9 and Remark 4.6.10, we've also proved positivity, because r can be chosen small enough so that $d(\varphi\lambda)$ is globally symplectic and tames \tilde{J} .

Reeb flow invariance is easy to prove: we just note that since $L_{X_\lambda} \lambda = 0$ and $L_{X_\lambda} d\lambda = 0$, any Reeb flow diffeomorphism $\Phi : M \rightarrow M$ defines an isometry of the contact structure with respect to the metric $|\cdot|_J^2 = d\lambda(\cdot, J\cdot)$. Then if $\varphi \in \mathcal{T}_L$ and $\tilde{\varphi}(a, x) = \varphi(a, \Phi(x))$, we have for any $(a, x) \in \mathbb{R} \times M$ and $v \in \xi_x$,

$$\begin{aligned}
|d\tilde{\varphi}(a, x)v|^2 &= |d\varphi(a, \Phi(x))\Phi_*v|^2 \leq 4\varphi(a, \Phi(x))\partial_a \varphi(a, \Phi(x))|\Phi_*v|_J^2 \\
&= 4\tilde{\varphi}(a, x)\partial_a \tilde{\varphi}(a, x)|v|_J^2.
\end{aligned}$$

So $\tilde{\varphi}$ satisfies the taming criterion. The pseudo-Lagrangian condition implies that $\tilde{\varphi}$ is also constant on the tori \tilde{L}_j^σ .

In the case where \tilde{L}_j^σ is an \mathbb{R} -invariant family, the set \mathcal{T}_L is clearly \mathbb{R} -invariant, and we conclude that it is indeed an \mathbb{R} -invariant taming set. More generally, we must prove asymptotic \mathbb{R} -invariance in the case where \tilde{L}_j^σ is not \mathbb{R} -invariant but is asymptotically flat. To do this, define both asymptotic taming sets \mathcal{T}^\pm to be the standard taming set \mathcal{T}_0 ; i.e. $\varphi \in \mathcal{T}^\pm$ means $\varphi(a, x)$ depends only on a and $\partial_a \varphi \geq 0$. Since the families \tilde{L}_j^σ are asymptotically flat, we can choose $a_0 > 0$ large enough so that all "non-flat" tori (graphs of non-constant functions $G_j^\sigma : L_j \rightarrow \mathbb{R}$) are contained in $[-a_0, a_0] \times M$. Choose any $a_1 > a_0$, and let $\beta : \mathbb{R} \rightarrow [0, 1]$ be a smooth function with $\beta(a) \equiv 0$ for $a \leq a_0$, $\beta(a) \equiv 1$ for $a \geq a_1$ and $\beta' \geq 0$. Then given any $\varphi^+ \in \mathcal{T}^+$, we can define $\psi^+ \in \mathcal{T}_L$ by

$$\psi^+(a, x) = \beta(a)\varphi^+(a, x),$$

so $\psi^+(a, x) = \varphi^+(a, x)$ for all $a \geq a_1$. Similarly, given $\varphi^- \in \mathcal{T}^-$, define $\psi^- \in \mathcal{T}_L$ by

$$\psi^-(a, x) = 1 - \beta(-a)[1 - \varphi^-(a, x)],$$

so $\psi^-(a, x) = \varphi^-(a, x)$ for all $a \leq -a_1$. The fact that ψ^\pm both belong to \mathcal{T}_L is easily verified since both are independent of x and are supported only in regions where all tori are flat. So the positivity axiom reduces to the requirement that $\partial_a \psi^\pm \geq 0$. \square

Compatible taming sets are useful because of the following energy bound.

Proposition 4.6.15. *Let \mathcal{T} be a compatible taming set for the family of tori $\tilde{L}_j^\sigma \subset \mathbb{R} \times M$. Suppose \tilde{u}_k is a sequence of solutions to **(BP)** that have the same asymptotic limits and such that for each component $\gamma_j \subset \partial\Sigma$, $u_k(\gamma_j)$ are homotopic loops on L_j for all k . Then there is a uniform energy bound $E_{\mathcal{T}}(\tilde{u}_\tau) < C$.*

Proof. For each puncture $z_j \in \Gamma$, let T_j be the period of the corresponding asymptotic limit, and choose a holomorphic embedding $\psi_j : \mathbb{D} \rightarrow \Sigma$ that sends 0 to z_j . Then

$$\lim_{\epsilon \rightarrow 0} \int_{\psi_j(\partial\mathbb{D}_\epsilon)} u_k^* \lambda = \pm T_j.$$

Using Stokes' theorem and the fact that $|\varphi| \leq 1$ for all $\varphi \in \mathcal{T}$, we have

$$\left| \int_{\dot{\Sigma}} \tilde{u}_k^* d(\varphi \lambda) \right| \leq \sum_{j=1}^{\#\Gamma} T_j + \left| \int_{\partial\Sigma} \tilde{u}_k^*(\varphi \lambda) \right|.$$

Moreover, since φ is constant on each of the totally real submanifolds \tilde{L}_j^σ , $\varphi \circ \tilde{u}$ is constant over each connected component $\gamma_j \subset \partial\Sigma$, hence

$$\left| \int_{\gamma_j} \tilde{u}_k^*(\varphi \lambda) \right| \leq \left| \int_{\gamma_j} u_k^* \lambda \right|.$$

Since $d\lambda$ vanishes on each torus L_j , the integral on the right depends only on the homotopy class of $u_k|_{\gamma_j} : \gamma_j \rightarrow L_j$. \square

4.6.3 Removing punctures on the boundary

We proved in Sec. 4.6.1 above that interior punctures of any \tilde{J} -holomorphic curve $\tilde{u} = (a, u) : \dot{\Sigma} \rightarrow \mathbb{R} \times M$ with finite energy (in the generalized sense) are either removable or asymptotic to a closed Reeb orbit. In the latter case, $a : \dot{\Sigma} \rightarrow \mathbb{R}$ goes to $\pm\infty$ at the puncture. For the purposes of compactness arguments, we must also understand what happens when a puncture appears on the boundary. One would expect such punctures to be removable since the boundary condition confines $\tilde{u}(\partial\Sigma)$ to a compact subset of $\mathbb{R} \times M$. One must then check that nothing horrible can happen in the interior near the puncture. This is indeed the case if the totally real submanifold is pseudo-Lagrangian—the author strongly suspects that it holds more generally as well, but we'll only prove it in the pseudo-Lagrangian case.

In the following, \mathcal{T} denotes either the standard taming set \mathcal{T}_0 or the set \mathcal{T}_L provided by Prop. 4.6.14, and we assume \mathcal{T} is compatible with some family of pseudo-Lagrangian tori containing \tilde{L} .

Theorem 4.6.16. *Suppose $\tilde{u} = (a, u) : \mathbb{D}^+ = \mathbb{D}^+ \setminus \{0\} \rightarrow \mathbb{R} \times M$ is a \tilde{J} -holomorphic map with $E_{\mathcal{T}}(\tilde{u}) < \infty$ and $\tilde{u}(\mathbb{D}^+ \cap \mathbb{R}) \subset \tilde{L}$ for some pseudo-Lagrangian torus $\tilde{L} \subset \mathbb{R} \times M$. Then \tilde{u} extends to a \tilde{J} -holomorphic half-disk $\mathbb{D}^+ \rightarrow \mathbb{R} \times M$ with $\tilde{u}(\mathbb{D}^+ \cap \mathbb{R}) \subset \tilde{L}$.*

As with the asymptotic results for interior punctures, the first step is to prove a special case involving solutions with zero contact area, which reduces the problem to complex analysis. Here we make use of the pseudo-Lagrangian condition in order to eliminate the boundary by means of the Schwartz reflection principle. In the following, \mathbb{H} denotes the closed upper half plane in \mathbb{C} .

Proposition 4.6.17. *Let $\tilde{u} = (a, u) : \mathbb{H} \rightarrow \mathbb{R} \times M$ be a \tilde{J} -holomorphic half-plane mapping \mathbb{R} into a pseudo-Lagrangian torus \tilde{L} , with finite energy $E_{\mathcal{T}}(\tilde{u}) < \infty$ and*

$$\int_{\mathbb{H}} u^* d\lambda = 0.$$

Then \tilde{u} is constant.

Proof. As in Prop. 4.6.6, the assumption of vanishing contact area implies that we can find a Reeb orbit $x : \mathbb{R} \rightarrow M$ and a smooth function $f : \mathbb{H} \rightarrow \mathbb{R}$ such that $u(s, t) = x(f(s, t))$. Then $\Phi = a + if : \mathbb{H} \rightarrow \mathbb{C}$ is holomorphic. Since $u(\mathbb{R})$ is contained in a Reeb orbit and $\tilde{u}(\mathbb{R}) \subset \tilde{L}$ with \tilde{L} tangent to X_λ , we conclude that a is constant on \mathbb{R} . Thus there is a number $a_0 \in \mathbb{R}$ such that $\Phi(\mathbb{R}) \subset a_0 + i\mathbb{R}$, and we can use the Schwartz reflection principle to extend Φ to an entire function $\tilde{\Phi} : \mathbb{C} \rightarrow \mathbb{C}$. Specifically, defining an antiholomorphic involution $f : \mathbb{C} \rightarrow \mathbb{C}$ by reflecting over the line $a_0 + i\mathbb{R}$, we have

$$\tilde{\Phi}(\bar{z}) = f(\tilde{\Phi}(z)).$$

For any $\varphi \in \mathcal{T}$, define a 2-form τ_φ on \mathbb{H} by $\tau_\varphi = \partial_s \varphi(s, x(t)) ds \wedge dt$. Repeating the calculation (4.6.4), we have

$$\int_{\mathbb{H}} \Phi^* \tau_\varphi = \int_{\mathbb{H}} \tilde{u}^* d(\varphi \lambda) \leq E_{\mathcal{T}}(\tilde{u}) < \infty$$

for all $\varphi \in \mathcal{T}$. We shall now adapt the bubbling off argument from the proof of Prop. 4.6.6 and show that in this situation as well, the finite energy assumption implies Φ is constant.

If $\nabla \Phi$ is bounded on \mathbb{H} then $\nabla \tilde{\Phi}$ is bounded on \mathbb{C} , implying that $\tilde{\Phi}$ (and hence Φ) is an affine function. Thus Φ maps \mathbb{H} diffeomorphically to a half-plane bounded by $a_0 + i\mathbb{R}$. Suppose the half-plane in question is $\Phi(\mathbb{H}) = \{s + it \mid s \leq a_0\}$, then

$$\int_{\mathbb{H}} \Phi^* \tau_\varphi = \int_{\Phi(\mathbb{H})} \tau_\varphi = \int_{-\infty}^{\infty} \int_{-\infty}^{a_0} \partial_s \varphi(s, x(t)) ds dt.$$

It's easy to see that one can choose $\varphi \in \mathcal{T}$ so that this integral is infinite: just choose any $\psi \in \mathcal{T}_0$ with $\psi' > 0$ and find a taming function $\varphi \in \mathcal{T}$ such that $\varphi(a, x) = \psi(a)$ for a near $-\infty$. A similar argument shows that the energy must also be infinite if $\Phi(\mathbb{H}) = \{s + it \mid s \geq a_0\}$. We conclude that there is no affine function $\mathbb{H} \rightarrow \mathbb{C}$ that takes \mathbb{R} to $a_0 + i\mathbb{R}$ and has finite energy.

We will find a contradiction also if $\nabla\Phi$ is unbounded. Assume $z_k = s_k + it_k \in \mathbb{H}$ with $R_k := |\nabla\Phi(z_k)| \rightarrow \infty$, and choose positive numbers $\epsilon_k \rightarrow 0$ with $\epsilon_k R_k \rightarrow \infty$. By Lemma 4.6.5 we can assume that $|\nabla\Phi(z)| \leq 2|\nabla\Phi(z_k)|$ whenever $|z - z_k| \leq \epsilon_k$. We will find that either a plane or a half-plane bubbles off, depending on the behavior of the sequence $t_k R_k$. There are two cases to consider.

Case 1: assume $t_k R_k$ is unbounded. Passing to a subsequence, we may assume $t_k R_k \rightarrow \infty$, and thus $r_k := \min\{\epsilon_k R_k, t_k R_k\} \rightarrow \infty$. Defining $\psi_k : \mathbb{D}_{r_k} \hookrightarrow \mathbb{C}$ by

$$\psi_k(z) = z_k + \frac{z}{R_k},$$

we see that the image $\psi_k(\mathbb{D}_{r_k})$ is contained in \mathbb{H} , since $|z| \leq r_k$ implies $|\operatorname{Im} \psi_k(z) - t_k| \leq |\psi_k(z) - z_k| \leq r_k/R_k$, and $t_k \geq r_k/R_k$. Thus we can repeat the argument from Prop. 4.6.6, defining a sequence of rescaled maps $\Phi_k : \mathbb{D}_{r_k} \rightarrow \mathbb{C}$ which converge to a non-constant entire function $\Phi_\infty : \mathbb{C} \rightarrow \mathbb{C}$ with bounded gradient and finite energy; this is a contradiction. (In the case where $a_k := \operatorname{Re} \Phi(z_k)$ is unbounded, one must replace r_k with $\min\{\epsilon_k R_k, t_k R_k, \kappa|a_k|/2\}$ for some $\kappa \in (0, 1)$, then use the asymptotic \mathbb{R} -invariance axiom to prove finite energy, just as in Prop. 4.6.6.)

Case 2: assume $t_k R_k$ is bounded. Now the sequence z_k approaches the boundary of \mathbb{H} too fast, so a half-plane bubbles off instead of a plane. To see this, denote $\mathbb{D}_r^+ = \mathbb{D}_r \cap \mathbb{H}$, and define $\psi_k : \mathbb{D}_{\epsilon_k R_k}^+ \hookrightarrow \mathbb{H}$ by

$$\psi_k(z) = s_k + \frac{z}{R_k}.$$

Then if $f_k = \operatorname{Im} \Phi(s_k)$ and $F_k : \mathbb{C} \rightarrow \mathbb{C}$ is the translation $F_k(z) = z - if_k$, we define the rescaled maps $\Phi_k = F_k \circ \Phi \circ \psi_k : \mathbb{D}_{\epsilon_k R_k}^+ \rightarrow \mathbb{C}$, that is,

$$\Phi_k(z) = \Phi\left(s_k + \frac{z}{R_k}\right) - if_k.$$

These satisfy the boundary condition $\Phi_k(\mathbb{D}_{\epsilon_k R_k}^+ \cap \mathbb{R}) \subset a_0 + i\mathbb{R}$. Since $|\nabla\Phi_k(z)| \leq 2$ for all $z \in \mathbb{D}_{\epsilon_k R_k}^+$ and $\Phi_k(0) = \operatorname{Re} \Phi(s_k) \equiv a_0$, we can apply the Cauchy integral formula to obtain C^∞ -bounds and conclude that a subsequence converges in $C_{\text{loc}}^\infty(\mathbb{H}, \mathbb{C})$ to a holomorphic half-plane

$$\Phi_\infty : \mathbb{H} \rightarrow \mathbb{C} \quad \text{such that} \quad \Phi_\infty(\mathbb{R}) \subset a_0 + i\mathbb{R}.$$

We claim that Φ_∞ is not constant: indeed, $|\psi_k^{-1}(z_k)| = R_k|z_k - s_k| = t_k R_k$ is bounded by assumption, so we may assume $\psi_k^{-1}(z_k) \rightarrow \zeta \in \mathbb{H}$, and $|\nabla\Phi_\infty(\zeta)| = \lim_k |\nabla\Phi_k(\psi_k^{-1}(z_k))| = 1$. Φ_∞ also has finite energy, since for any $\varphi \in \mathcal{T}$ and any $r > 0$,

$$\begin{aligned} \int_{\mathbb{D}_r^+} \Phi_\infty^* \tau_\varphi &= \lim_{k \rightarrow \infty} \int_{\mathbb{D}_r^+} \Phi_k^* \tau_\varphi \leq \lim_{k \rightarrow \infty} \int_{\mathbb{D}_{\epsilon_k R_k}^+} \Phi_k^* \tau_\varphi \\ &= \lim_{k \rightarrow \infty} \int_{\mathbb{D}_{\epsilon_k R_k}^+} \psi_k^* \Phi^* F_k^* \tau_\varphi = \lim_{k \rightarrow \infty} \int_{\psi_k(\mathbb{D}_{\epsilon_k R_k}^+)} \Phi^* \tau_{\varphi_k} \\ &\leq \sup_k \int_{\mathbb{H}} \Phi^* \tau_{\varphi_k} \leq E_{\mathcal{T}}(\tilde{u}), \end{aligned}$$

where $\varphi_k(a, x) = \varphi(a, \Phi_{X_\lambda}^{-f_k}(x))$. This leads to a contradiction since Φ_∞ extends to an entire function by the Schwartz reflection principle, and is therefore affine. As we argued above, such functions cannot have finite energy. \square

Proof of Theorem 4.6.16. It will suffice to prove that $\tilde{u}(\mathbb{D}^+)$ is contained in a compact set $K \subset \mathbb{R} \times M$; then we can choose a taming function such that $d(\varphi\lambda)$ is a symplectic form on K and \tilde{L} is Lagrangian, so the result follows from the boundary version of Gromov's removable singularity theorem (see [MS04]).

To prove that $\tilde{u}(\mathbb{D}^+)$ is bounded, compose \tilde{u} with the biholomorphic map $\psi : [0, \infty) \times [0, 1] \rightarrow \mathbb{D}^+ : (s, t) \mapsto e^{-\pi(s+it)}$ and consider the pseudoholomorphic half-strip

$$\tilde{v} = (b, v) = \tilde{u} \circ \psi : [0, \infty) \times [0, 1] \rightarrow \mathbb{R} \times M.$$

We claim that $|\nabla\tilde{v}|$ is bounded on $[0, \infty) \times [0, 1]$. This will prove the theorem, since $\tilde{v}([0, \infty) \times \{0\})$ and $\tilde{v}([0, \infty) \times \{1\})$ are contained in the compact set \tilde{L} .

If $|\nabla\tilde{v}|$ is not bounded, there is a sequence $z_k = s_k + it_k \in [0, \infty) \times [0, 1] \subset \mathbb{C}$ such that $R_k := |\nabla\tilde{v}(z_k)| \rightarrow \infty$. We may assume $s_k \rightarrow \infty$. Choose a sequence of positive numbers $\epsilon_k \rightarrow 0$ such that $\epsilon_k R_k \rightarrow \infty$; by Lemma 4.6.5 we can assume without loss of generality that $|\nabla\tilde{v}(z)| \leq 2|\nabla\tilde{v}(z_k)|$ whenever $|z - z_k| \leq \epsilon_k$. We will define a sequence of rescaled maps which converge to either a plane or a half-plane, depending on whether and how fast z_k approaches the boundary of $[0, \infty) \times [0, 1]$. We consider three cases.

Case 1: assume $t_k R_k$ and $(1 - t_k)R_k$ are both unbounded: then we can pass to a subsequence so that both approach ∞ . Let $r_k := \min\{\epsilon_k R_k, t_k R_k, (1 - t_k)R_k\}$, so $r_k \rightarrow \infty$ and we can define embeddings

$$\psi_k : \mathbb{D}_{r_k} \hookrightarrow [0, \infty) \rightarrow [0, 1] : z \mapsto z_k + \frac{z}{R_k}.$$

With this one can define rescaled maps $\tilde{v}_k : \mathbb{D}_{r_k} \rightarrow \mathbb{R} \times M$ precisely as in the proof of Theorem 4.6.4; a subsequence of these converges in $C_{\text{loc}}^\infty(\mathbb{C}, \mathbb{R} \times M)$ to a non-constant finite energy plane $\tilde{v}_\infty : \mathbb{C} \rightarrow \mathbb{R} \times M$ with vanishing contact area $\int_{\mathbb{C}} \tilde{v}_\infty^* d\lambda = 0$. This is a contradiction, by Prop. 4.6.6.

Case 2: assume $t_k R_k$ is bounded. This means z_k is approaching the half-line $[0, \infty) \times \{0\}$. Let

$$\psi_k : \mathbb{D}_{\epsilon_k R_k}^+ \hookrightarrow [0, \infty) \rightarrow [0, 1] : z \mapsto s_k + \frac{z}{R_k},$$

and define a sequence of rescaled maps $\tilde{v}_k : \mathbb{D}_{\epsilon_k R_k}^+ \rightarrow \mathbb{R} \times M$ by $\tilde{v}_k = \tilde{v} \circ \psi_k$. These maps satisfy the boundary condition $\tilde{v}_k(\mathbb{D}_{\epsilon_k R_k}^+ \cap \mathbb{R}) \subset \tilde{L}$. Moreover, the points $\tilde{v}_k(0) = \tilde{v}(s_k)$ are contained in the compact set \tilde{L} , and there is a uniform gradient bound $|\tilde{v}_k(z)| \leq 2$ for all $z \in \mathbb{D}_{\epsilon_k R_k}^+$. Thus a subsequence converges in $C_{\text{loc}}^\infty(\mathbb{H}, \mathbb{R} \times M)$ to a \tilde{J} -holomorphic half-plane $\tilde{v}_\infty : \mathbb{H} \rightarrow \mathbb{R} \times M$, with finite energy since for any $\varphi \in \mathcal{T}$,

$$\int_{\mathbb{D}_{\epsilon_k R_k}^+} \tilde{v}_k^* d(\varphi\lambda) = \int_{\psi_k(\mathbb{D}_{\epsilon_k R_k}^+)} \tilde{v}^* d(\varphi\lambda) \leq \int_{[0, \infty) \times [0, 1]} \tilde{v}^* d(\varphi\lambda) \leq E_{\mathcal{T}}(\tilde{v}).$$

Moreover,

$$\int_{\mathbb{D}_{\epsilon_k R_k}^+} v_k^* d\lambda = \int_{\psi_k(\mathbb{D}_{\epsilon_k R_k}^+)} v^* d\lambda \leq \int_{[s_k - \epsilon_k, \infty) \times [0, 1]} v^* d\lambda \rightarrow 0 \quad \text{as } k \rightarrow \infty,$$

thus $\int_{\mathbb{H}} \tilde{v}_\infty^* d\lambda = 0$. We claim however that \tilde{v}_∞ is not constant. Indeed, $|\psi_k^{-1}(z_k)| = R_k |z_k - s_k| = t_k R_k$ is bounded, thus passing to a subsequence, $\psi_k^{-1}(z_k) \rightarrow \zeta \in \mathbb{H}$, and $|\nabla \tilde{v}_\infty(\zeta)| = \lim_k |\nabla \tilde{v}_k(\psi_k^{-1}(z_k))| = 1$. Thus \tilde{v}_∞ is a non-constant finite energy half-plane with vanishing contact area, in contradiction to Prop. 4.6.17.

Case 3: assume $(1 - t_k)R_k$ is bounded. This is very similar to the previous case; this time z_k is approaching the half-line $[0, \infty) \times \{1\}$, so we rescale using the embeddings

$$\psi_k : \mathbb{D}_{\epsilon_k R_k}^+ \hookrightarrow [0, \infty) \rightarrow [0, 1] : z \mapsto (s_k + i) - \frac{z}{R_k}.$$

Then by the same arguments used above, $\tilde{v}_k = \tilde{v} \circ \psi_k$ has a subsequence convergent to a non-constant finite energy half-plane $\tilde{v}_\infty : \mathbb{H} \rightarrow \mathbb{R} \times M$ with boundary condition $\tilde{v}(\mathbb{R}) \subset \tilde{L}$ and vanishing contact area, once again contradicting Prop. 4.6.17. \square

We conclude this section with a result for holomorphic disks with vanishing contact area. In the pseudo-Lagrangian case it follows immediately from Prop. 4.6.17, but a simpler proof is also available without the pseudo-Lagrangian condition. Assume $G : L \rightarrow \mathbb{R}$ is any smooth function on a torus $L \subset M$ tangent to X_λ , and define \tilde{L} as the graph of G in $\mathbb{R} \times M$.

Proposition 4.6.18. *Let $\tilde{u} = (a, u) : \mathbb{D} \rightarrow \mathbb{R} \times M$ be a \tilde{J} -holomorphic disk mapping $\partial\mathbb{D}$ into the totally real torus \tilde{L} , such that*

$$\int_{\mathbb{D}} u^* d\lambda = 0.$$

Then \tilde{u} is constant.

Proof. Since $u^* d\lambda \equiv 0$, we can write $\tilde{u}(z) = (a(z), x(f(z)))$ where $x : \mathbb{R} \rightarrow M$ is a Reeb orbit and $\Phi = a + if : \mathbb{D} \rightarrow \mathbb{C}$ is a holomorphic function. Then Φ maps $\partial\mathbb{D}$ into the smooth 1-dimensional submanifold

$$\gamma = \{G(x(t)) + it \in \mathbb{C} \mid t \in \mathbb{R}\}.$$

Since γ is not a closed curve, we have $\text{wind}_{\partial\mathbb{D}}(\Phi, w) = 0$ for any point $w \in \mathbb{C} \setminus \gamma$, thus the image of Φ is contained in γ . By the open mapping theorem, Φ is therefore constant. \square

4.6.4 Localization at the punctures

This section addresses the following question: given a C_{loc}^∞ -convergent sequence of holomorphic curves, what can be said about the behavior of the sequence near the punctures? A uniform energy bound gives some useful consequences in this situation, and we can also consider the scenario in which components of the boundary degenerate to punctures; this will be important for the foliation construction in the next chapter.

As always, M is a closed 3-manifold. Let λ_k be a compact sequence of contact forms on M , converging in C^∞ to a contact form λ_∞ . Similarly, pick a compact sequence $J_k \rightarrow J_\infty$ of admissible complex multiplications on the contact structures $\xi_k = \ker \lambda_k$, and define the corresponding almost complex structures $\tilde{J}_k \rightarrow \tilde{J}_\infty$ on $\mathbb{R} \times M$.

To define a domain for holomorphic curves, let S be a closed oriented surface with a finite subset

$$\Gamma \cup \Gamma' = \{z_1, \dots, z_n\} \cup \{z_{n+1}, \dots, z_{n+p}\} \subset S$$

for some $n = \#\Gamma \geq 0$ and $p = \#\Gamma' \geq 0$. Choose also two collections of open disks with pairwise disjoint closures,

$$\mathcal{D} = \mathcal{D}_1 \cup \dots \cup \mathcal{D}_m \subset S, \quad \mathcal{D}' = \mathcal{D}_{m+1} \cup \dots \cup \mathcal{D}_{m+p} \subset S$$

for some $m \geq 0$, such that $\overline{\mathcal{D}} \cap (\Gamma \cup \Gamma') = \emptyset$ and $\overline{\mathcal{D}'} \cap (\overline{\mathcal{D}} \cup \Gamma) = \emptyset$. Then we define two compact surfaces with boundary

$$\Sigma = S \setminus (\mathcal{D} \cup \mathcal{D}'), \quad \Sigma' = S \setminus \mathcal{D},$$

and observe that

$$\dot{\Sigma} := \Sigma \setminus \Gamma \quad \text{and} \quad \dot{\Sigma}' := \Sigma' \setminus (\Gamma \cup \Gamma')$$

have only interior punctures. Denote the oriented boundary circles $\gamma_j = -\partial\overline{\mathcal{D}}_j$ for $j \in \{1, \dots, m+p\}$, thus

$$\partial\Sigma = \gamma_1 \cup \dots \cup \gamma_{m+p}, \quad \partial\Sigma' = \gamma_1 \cup \dots \cup \gamma_m.$$

The compactified surfaces $\overline{\Sigma}$ and $\overline{\Sigma}'$ are homeomorphic, with a natural correspondence between their respective boundary components; i.e. for each $j \in \{1, \dots, p\}$, the circle at infinity in $\overline{\Sigma}'$ for $z_{n+j} \in \Gamma'$ corresponds to the circle $\gamma_{m+j} \subset \partial\Sigma \subset \partial\overline{\Sigma}$.

For each $j \in \{1, \dots, n\}$, assume there is a submanifold $N_j \subset M$ which is either a circle or a 2-torus, such that for all the contact forms $\{\lambda_k\}_{k \leq \infty}$, N_j is either a nondegenerate periodic orbit or a simple Morse-Bott torus of periodic orbits. Similarly for each $j \in \{1, \dots, m+p\}$, choose a 2-torus $L_j \subset M$ tangent to X_{λ_k} for all $k \leq \infty$, covered by an asymptotically \mathbb{R} -invariant family of tori $\{\tilde{L}_j^\sigma \subset \mathbb{R} \times M\}_{\sigma \in \mathbb{R}}$, which are pseudo-Lagrangian with respect to λ_k for all $k \leq \infty$. Assume also that for each $j \in \{1, \dots, p\}$, $N_{n+j} := L_{m+j}$ is a simple Morse-Bott manifold with respect to λ_∞ . Finally, assume there exists a compatible taming set \mathcal{T} for the families \tilde{L}_j^σ ; this is clearly true, e.g. if the tori L_1, \dots, L_{m+j} are all disjoint and the families \tilde{L}_j^σ are \mathbb{R} -invariant or asymptotically flat.

Theorem 4.6.19. *For $k < \infty$, let $\tilde{u}_k = (a_k, u_k) : \dot{\Sigma} \rightarrow \mathbb{R} \times M$ be a sequence of \tilde{J}_k -holomorphic solutions to Problem (BP) such that:*

1. *Each \tilde{u}_k satisfies the boundary condition $\tilde{u}_k(\gamma_j) \subset \tilde{L}_j^\sigma$ for $j \in \{1, \dots, m+p\}$.*
2. *For $j \in \{1, \dots, n\}$, the puncture $z_j \in \Gamma$ has the same sign $\epsilon_j = \pm 1$ for each \tilde{u}_k and is asymptotic to an orbit in N_j .*
3. *For $j \in \{1, \dots, p\}$, the oriented loops $u_k(\gamma_{m+j})$ are homotopic to the periodic orbits on the Morse-Bott torus N_{m+j} , up to orientation (denoted here by the sign $\epsilon_{n+j} = \pm 1$).*

Suppose there is a sequence of diffeomorphisms

$$\varphi_k : \Sigma' \setminus \Gamma' \rightarrow \Sigma \setminus \partial\overline{\mathcal{D}'},$$

which extend to homeomorphisms $\bar{\varphi}_k : \bar{\Sigma}' \rightarrow \bar{\Sigma}$ identifying the corresponding boundary components, such that $\tilde{u}_k \circ \varphi_k|_{\dot{\Sigma}'}$ converges in $C_{\text{loc}}^\infty(\dot{\Sigma}', \mathbb{R} \times M)$ to a \tilde{J}_∞ -holomorphic map

$$\tilde{u}_\infty = (a_\infty, u_\infty) : \dot{\Sigma}' \rightarrow \mathbb{R} \times M,$$

satisfying the boundary condition $\tilde{u}_\infty(\gamma_j) \subset \tilde{L}_j^\sigma$ for $j \in \{1, \dots, m\}$, and having asymptotic limits in N_j at $z_j \in \Gamma \cup \Gamma'$ with sign ϵ_j , for $j \in \{1, \dots, n+p\}$. Then for any sequence $\zeta_k \in \dot{\Sigma}'$ converging to a puncture $z_j \in \Gamma \cup \Gamma'$, $u_k \circ \varphi_k(\zeta_k) \rightarrow N_j$. In fact, there is a shrinking sequence of circles $C_k \subset \dot{\Sigma}$ around z_j containing ζ_k such that $u_k \circ \varphi_k(C_k)$ converges in C^∞ (up to parametrization) to an orbit in N_j .

The point is that even though \tilde{u}_k is only known to converge on compact subsets away from the punctures, its behavior near the punctures cannot stray from a neighborhood of the corresponding Morse-Bott manifolds. It may be possible to prove a stronger version of this statement using some version of the “long cylinder lemma” from [HWZ03a], but that is more effort than is needed for our purposes.

The theorem follows from bubbling off arguments for sequences of finite energy half-cylinders—this requires careful choices of coordinates near each puncture. Denote $\mathbb{D} = \mathbb{D} \setminus \{0\}$.

Lemma 4.6.20. *Let j_k be a sequence of complex structures on \mathbb{D} such that $j_k \rightarrow i$ in $C_{\text{loc}}^\infty(\mathbb{D})$, and take a sequence of biholomorphic maps*

$$\psi_k : ([0, R_k) \times S^1, i) \rightarrow (\mathbb{D}, j_k)$$

for $R_k \in (0, \infty]$. Then $R_k \rightarrow \infty$, and ψ_k converges in $C_{\text{loc}}^\infty([0, \infty) \times S^1, \mathbb{D})$ to a biholomorphic map $\psi : ([0, \infty) \times S^1, i) \rightarrow (\mathbb{D}, i)$.

Proof. It’s easier first to prove compactness for the inverses ψ_k^{-1} , since the complex structure on the target space is then fixed. Let $f : [0, \infty) \times S^1 \rightarrow \mathbb{D} : (s, t) \mapsto e^{-2\pi(s+it)}$ and consider the sequence of biholomorphic maps

$$\varphi_k = \psi_k^{-1} \circ f : ([0, \infty) \times S^1, i_k) \rightarrow ([0, R_k) \times S^1, i),$$

where $i_k := f^*j_k \rightarrow i$ in $C_{\text{loc}}^\infty([0, \infty) \times S^1)$. By the natural inclusion we can regard these as i_k - i -holomorphic embeddings of $[0, \infty) \times S^1$ into itself. A bubbling off argument shows that these maps satisfy a uniform gradient bound in any compact subset of $[0, \infty) \times S^1$. Indeed, suppose there is a sequence $(s_k, t_k) \in [0, \infty) \times S^1$ such that $R_k = |\nabla \varphi_k(s_k, t_k)| \rightarrow \infty$ and s_k is bounded. If s_k doesn’t approach zero too fast, then by the usual rescaling argument we derive a sequence converging to a non-constant entire function

$$\Phi : \mathbb{C} \rightarrow [0, \infty) \times S^1.$$

But applying Liouville's theorem to $f \circ \Phi : \mathbb{C} \rightarrow \mathring{\mathbb{D}}$, we conclude that Φ must be constant, a contradiction. Alternatively if $s_k \rightarrow 0$ fast enough, we rescale around points on the boundary and obtain a non-constant holomorphic half-plane

$$\Phi : \mathbb{H} \rightarrow [0, \infty) \times S^1$$

with bounded first derivative and the boundary condition $\Phi(\mathbb{R}) \subset \{0\} \times S^1$. We can assume $\Phi(0) = (0, 0)$ without loss of generality. Now let $\mathbb{H}^R = [0, \infty) \times \mathbb{R} \subset \mathbb{C}$, and consider the natural holomorphic covering map

$$p : \mathbb{H}^R \rightarrow [0, \infty) \times S^1.$$

There is a unique lift $\tilde{\Phi} : \mathbb{H} \rightarrow \mathbb{H}^R$ such that $p \circ \tilde{\Phi} = \Phi$ and $\tilde{\Phi}(0) = 0$; moreover $\tilde{\Phi}$ is holomorphic, has bounded derivative and maps \mathbb{R} to $i\mathbb{R}$. Thus the reflection principle extends $\tilde{\Phi}$ to an entire function with bounded derivative, which therefore takes the form $\tilde{\Phi}(z) = i\lambda z$ for some $\lambda \in \mathbb{R} \setminus \{0\}$. But this contradicts the injectivity of φ_k , since it implies that the restriction of Φ to any large compact subinterval of \mathbb{R} covers $S^1 \times \{0\}$ arbitrarily many times, and we can then make a similar statement about φ_k for large k . This proves the gradient bound.

In light of this, a subsequence of φ_k converges in C_{loc}^∞ to a holomorphic map $\varphi : [0, \infty) \times S^1 \rightarrow [0, \infty) \times S^1$, and $g_k := f \circ \varphi_k \circ f^{-1}$ converges to

$$g := f \circ \varphi \circ f^{-1} : \mathring{\mathbb{D}} \rightarrow \mathring{\mathbb{D}},$$

which is holomorphic and maps $\partial\mathbb{D}$ to itself. In fact, $g(\partial\mathbb{D})$ winds once around the interior of \mathbb{D} , and the singularity at 0 is removable, thus g extends to a holomorphic map $\mathbb{D} \rightarrow \mathbb{D}$ that hits every point in $\text{int } \mathbb{D}$ exactly once. This means g is an automorphism of the disk with $g(0) = 0$, i.e. a rotation. We conclude that

$$\varphi(s, t) = (s, t + t_0) \tag{4.6.6}$$

for some $t_0 \in S^1$. This also shows that $R_k \rightarrow \infty$, since otherwise we could find a subsequence of φ_k with uniformly bounded image in $[0, \infty) \times S^1$, and these could not converge to φ .

A simple point set topology argument can now be used to establish uniform C_{loc}^0 -bounds for φ_k^{-1} . Indeed, suppose $w_k \in [0, R_k) \times S^1$ is a bounded sequence and let $z_k = \varphi_k^{-1}(w_k)$. Taking a subsequence, we may assume $w_k \rightarrow w_\infty \in [0, \infty) \times S^1$. Let $z_\infty = \varphi^{-1}(w_\infty)$, and choose an open ball B around z_∞ . Since φ_k converges uniformly on \bar{B} , there is a ball B' around w_∞ such that $\text{wind}_{\partial B'}(\varphi_k; w) = 1$ for all $w \in B'$ and sufficiently large k . Thus $B' \subset \varphi_k(B)$ for all k large. Since $w_k \rightarrow w_\infty$, this means $w_k \in \varphi_k(B)$ for sufficiently large k , so $z_k \in B$. In particular z_k is bounded; in fact, $z_k \rightarrow z_\infty$.

We now know that for any compact subset $K \subset [0, \infty) \times S^1$, $\varphi_k^{-1}(K)$ is contained in another compact subset, on which the complex structure i_k is C^∞ -convergent to i . Thus the above arguments can be repeated to derive uniform gradient bounds and a subsequence of φ_k^{-1} that converges in C_{loc}^∞ to a biholomorphic map of the form (4.6.6). We conclude that $\psi_k = f \circ \varphi_k^{-1}$ also converges in C_{loc}^∞ to a biholomorphic map $\psi : [0, \infty) \times S^1 \rightarrow \mathbb{D}$. \square

Remark 4.6.21. *If we compose the sequence ψ_k in the above lemma with rotations so that $\psi_k(0, 0) = 1$, then the limit is uniquely determined: it's $\psi(s, t) = e^{-2\pi(s+it)}$.*

Proof of Theorem 4.6.19. Denote $j_k = \tilde{u}_k^* \tilde{J}_k$, a sequence of complex structures on $\dot{\Sigma}$ which extend smoothly over the punctures to Σ . Similarly, $j_\infty = \tilde{u}_\infty^* \tilde{J}_\infty$ defines a complex structure on Σ' , and we have $\varphi_k^* j_k \rightarrow j_\infty$ in $C_{\text{loc}}^\infty(\dot{\Sigma}')$.

We examine first the behavior in a neighborhood of one of the punctures $z_{n+j} \in \Gamma' \subset \Sigma'$, which is the limit of a degenerating circle $\gamma_{m+j} \subset \partial\Sigma$. Choose a closed neighborhood $z_{n+j} \in \mathcal{U} \subset \Sigma'$ such that (\mathcal{U}, j_∞) can be identified conformally with (\mathbb{D}, i) . Denote $\dot{\mathcal{U}} = \mathcal{U} \setminus \{z_{n+j}\} \subset \dot{\Sigma}'$ and let $\bar{\mathcal{U}} \subset \bar{\Sigma}'$ be the circle compactification of \mathcal{U} . Then for each k the annulus $A_k := \bar{\varphi}_k(\bar{\mathcal{U}}) \subset \Sigma$ with complex structure j_k is conformally equivalent to $[0, R_k] \times S^1$ for some $R_k > 0$; this follows from the classification of conformal structures on annuli (cf. [Hm97], Lemma 5.1). We can therefore define homeomorphisms $\bar{\psi}_k : [0, R_k] \times S^1 \rightarrow \bar{\mathcal{U}}$ which restrict to biholomorphic maps

$$\psi_k : ([0, R_k] \times S^1, i) \rightarrow (\dot{\mathcal{U}}, \varphi_k^* j_k),$$

and by Lemma 4.6.20 there is a biholomorphic map

$$\psi : ([0, \infty) \times S^1, i) \rightarrow (\dot{\mathcal{U}}, j_\infty)$$

such that $\psi_k \rightarrow \psi$ in $C_{\text{loc}}^\infty([0, \infty) \times S^1, \dot{\mathcal{U}})$. Now define a sequence of \tilde{J}_k -holomorphic annuli

$$\tilde{v}_k = (b_k, v_k) = \tilde{u}_k \circ \bar{\varphi}_k \circ \bar{\psi}_k : [0, R_k] \times S^1 \rightarrow \mathbb{R} \times M,$$

which satisfy a boundary condition of the form $\tilde{v}_k(\{R_k\} \times S^1) \subset \tilde{L}_{m+j}^{\sigma_k}$. These converge in $C_{\text{loc}}^\infty([0, \infty) \times S^1, \mathbb{R} \times M)$ to a \tilde{J}_∞ -holomorphic half-cylinder

$$\tilde{v}_\infty = (b_\infty, v_\infty) = \tilde{u}_\infty \circ \psi : [0, \infty) \times S^1 \rightarrow \mathbb{R} \times M.$$

The energies

$$E_k(\tilde{u}_k) = \sup_{\varphi \in \mathcal{T}} \int_{\dot{\Sigma}} \tilde{u}^* d(\varphi \lambda_k)$$

are uniformly bounded by Prop. 4.6.15; only a slight modification of the proof is required to account for the varying contact form. Thus there is also a uniform bound

$$E_k(\tilde{v}_k) = \sup_{\varphi \in \mathcal{T}} \int_{[0, R_k] \times S^1} \tilde{v}^* d(\varphi \lambda_k) < C.$$

As for the contact area, we claim that for any sequence $s_k \rightarrow \infty$ with $s_k \leq R_k$,

$$\int_{[s_k, R_k] \times S^1} v_k^* d\lambda_k \rightarrow 0.$$

Indeed, by assumption $v_k(\{R_k\} \times S^1) = u_k(\gamma_{m+j})$ is homotopic to the asymptotic limit of \tilde{u}_∞ at $z_{n+j} \in \Gamma'$, so

$$\lim_{k \rightarrow \infty} \int_{\{R_k\} \times S^1} v_k^* \lambda_k = \lim_{s \rightarrow \infty} \int_{\{s\} \times S^1} v_\infty^* \lambda_\infty =: Q_0.$$

Now for any $\epsilon > 0$, we can assume

$$\left| Q_0 - \int_{\{R_k\} \times S^1} v_k^* \lambda_k \right| < \epsilon$$

for sufficiently large k , and choose $c \in (0, \infty)$ such that

$$\int_{[c, \infty) \times S^1} v_\infty^* d\lambda_\infty < \epsilon,$$

hence

$$\left| Q_0 - \int_{\{c\} \times S^1} v_\infty^* \lambda_\infty \right| < \epsilon.$$

Then for sufficiently large k , we can also assume

$$\left| Q_0 - \int_{\{c\} \times S^1} v_k^* \lambda_k \right| < 2\epsilon,$$

and thus using the positivity of $v_k^* d\lambda_k$,

$$\int_{[s_k, R_k]} v_k^* d\lambda_k \leq \int_{[c, R_k]} v_k^* d\lambda_k = \int_{\{R_k\} \times S^1} v_k^* \lambda_k - \int_{\{c\} \times S^1} v_k^* \lambda_k < 3\epsilon.$$

This proves the claim.

The decaying contact area implies a uniform gradient bound for the maps $\tilde{v}_k : [0, R_k] \times S^1 \rightarrow \mathbb{R} \times M$. The argument is familiar: if $|\nabla \tilde{v}_k(s_k, t_k)| \rightarrow \infty$, we can

assume $s_k \rightarrow \infty$, and thus bubble off either a plane or (if s_k stays close to R_k) a half-plane with finite energy and zero contact area. Such a beast must be constant, yielding a contradiction. Thus there is a bound $|\nabla \tilde{v}_k| \leq C$.

Now take any sequence $s_k \rightarrow \infty$ with $s_k \leq R_k$ and distinguish two cases.

Case 1: assume $R_k - s_k \rightarrow \infty$. Then define

$$\tilde{w}_k = (\beta_k, w_k) : [-s_k, R_k - s_k] \times S^1 \rightarrow \mathbb{R} \times M$$

by $\tilde{w}_k(s, t) = \tilde{v}_k(s + s_k, t)$. By the uniform gradient bound, a subsequence converges in $C_{\text{loc}}^\infty(\mathbb{R} \times S^1, \mathbb{R} \times M)$ (possibly after \mathbb{R} -translation) to a \tilde{J}_∞ -holomorphic cylinder

$$\tilde{w}_\infty = (\beta_\infty, w_\infty) : \mathbb{R} \times S^1 \rightarrow \mathbb{R} \times M,$$

which has zero contact area since

$$\int_{[-s_k/2, R_k - s_k] \times S^1} w_k^* d\lambda_k = \int_{[s_k/2, R_k] \times S^1} v_k^* d\lambda_k \rightarrow 0.$$

Thus \tilde{w} is an orbit cylinder: $\tilde{w}(s, t) = (Qs + s_0, x(Qt))$ for some $s_0 \in \mathbb{R}$ and a closed Reeb orbit $x : \mathbb{R} \rightarrow M$ with period $T = |Q|$, and

$$\begin{aligned} Q &= \lim_{k \rightarrow \infty} \int_{\{0\} \times S^1} w_k^* \lambda_k = \lim_{k \rightarrow \infty} \int_{\{s_k\} \times S^1} v_k^* \lambda_k \\ &= \lim_{k \rightarrow \infty} \left(\int_{\{R_k\} \times S^1} v_k^* \lambda_k - \int_{[s_k, R_k] \times S^1} v_k^* d\lambda_k \right) \rightarrow Q_0 \neq 0. \end{aligned}$$

In particular, this shows that a subsequence of $v_k(s_k, \cdot)$ converges in $C^\infty(S^1, M)$ to a nontrivial periodic orbit of X_{λ_∞} .

Case 2: assume $R_k - s_k$ has a bounded subsequence. Now define

$$\tilde{w}_k = (\beta_k, w_k) : [-R_k, 0] \times S^1 \rightarrow \mathbb{R} \times M,$$

$\tilde{w}_k(s, t) = \tilde{v}_k(s + R_k, t)$. These maps satisfy the boundary condition $\tilde{w}_k(\{0\} \times S^1) \subset \tilde{L}_{m+j}^{\sigma_k}$, and using the gradient bound together with the asymptotic \mathbb{R} -invariance of the family \tilde{L}_{m+j}^σ , there is a subsequence converging in $C_{\text{loc}}^\infty((-\infty, 0] \times S^1, \mathbb{R} \times M)$ after \mathbb{R} -translation to a \tilde{J}_∞ -holomorphic half-cylinder

$$\tilde{w}_\infty = (\beta_\infty, w_\infty) : (-\infty, 0] \times S^1 \rightarrow \mathbb{R} \times M$$

mapping $\{0\} \times S^1$ into some pseudo-Lagrangian torus \tilde{L} . The contact area vanishes again since

$$\int_{[-R_k/2, 0] \times S^1} w_k^* d\lambda_k = \int_{[R/2, R_k] \times S^1} v_k^* d\lambda_k \rightarrow 0.$$

We claim that \tilde{w}_∞ is a portion of an orbit cylinder. To see this, denote $\mathbb{H}_L = \{s + it \mid s \leq 0\} \subset \mathbb{C}$ and treat \tilde{w}_∞ as a map $\mathbb{H}_L \rightarrow \mathbb{R} \times M$ which is 1-periodic in t . We can then write $\tilde{w}_\infty(s, t) = (\beta_\infty(s, t), x(f_\infty(s, t)))$ where $x : \mathbb{R} \rightarrow M$ is a (not necessarily closed) Reeb orbit and $\Phi := \beta_\infty + if_\infty : \mathbb{H}_L \rightarrow \mathbb{C}$ is a holomorphic function. Assume without loss of generality that $\Phi(0, 0) = 0$. Then since \tilde{L} is pseudo-Lagrangian, $\beta_\infty(0, t) = 0$ for all t , so Φ maps $i\mathbb{R}$ to itself, and can be extended to an entire function by the Schwartz reflection principle. There is a global bound for Φ' ; this follows from the gradient bound $|\nabla \tilde{w}_k| \leq C$, which gives a global bound on $|\nabla \tilde{w}_\infty|$ and hence $|\nabla \beta_\infty|$. Thus by Liouville's theorem, Φ is an affine function, and the same argument as before then shows that

$$\tilde{w}_\infty = (Qs, x(Qt)),$$

where

$$Q = \lim_{k \rightarrow \infty} \int_{\{0\} \times S^1} w_k^* \lambda_k = \lim_{k \rightarrow \infty} \int_{\{R_k\} \times S^1} v_k^* \lambda_k = Q_0 \neq 0.$$

Since a subsequence of $R_k - s_k$ is bounded, this proves once more that a subsequence of $v_k(s_k, \cdot)$ converges to a nontrivial periodic orbit of X_{λ_∞} .

We can now complete the proof for any sequence $\zeta_k \rightarrow z_{n+j} \in \Gamma'$. Indeed, there is a sequence $(s_k, t_k) \in [0, R_k) \times S^1$ such that $\psi_k(s_k, t_k) = \zeta_k$, and we know $s_k \rightarrow \infty$ since otherwise there is a convergent subsequence $(s_k, t_k) \rightarrow (s_\infty, t_\infty)$ and $\zeta_k = \psi_k(s_k, t_k) \rightarrow \psi(s_\infty, t_\infty) \notin \Gamma'$. We've just shown that a subsequence of $v_k(s_k, \cdot) = u_k \circ \varphi_k(\psi_k(s_k, \cdot))$ converges in $C^\infty(S^1, M)$ to some loop $y : S^1 \rightarrow M$ that parametrizes a periodic orbit $P \subset M$, and we claim $P \subset N_{n+j}$. If not, let

$$\mathcal{N} = \{x \in C^\infty(S^1, M) \mid x(S^1) \subset N_{n+j}\},$$

and choose open neighborhoods \mathcal{V} and \mathcal{V}' such that

$$\mathcal{N} \subset \mathcal{V} \subset \overline{\mathcal{V}} \subset \mathcal{V}' \subset C^\infty(S^1, M).$$

All parametrizations of the periodic orbits in N_{n+j} are contained in \mathcal{N} , and by the nondegeneracy/Morse-Bott condition, we can assume that $\overline{\mathcal{V}'}$ contains no other periodic orbits of X_{λ_∞} . Then since $L_{m+j} = N_{n+j}$ we have $v_k(R_k, \cdot) \in \mathcal{N}$, so there is a sequence $s'_k \in (s_k, R_k)$ such that $v_k(s'_k, \cdot) \in \mathcal{V}' \setminus \mathcal{V}$. But there are no periodic orbits in $\overline{\mathcal{V}'} \setminus \mathcal{V}$, thus no subsequence of $v_k(s'_k, \cdot)$ can converge to a periodic orbit, which is a contradiction.

The case of a sequence $\zeta_k \rightarrow z_j \in \Gamma \subset \Sigma'$ is slightly simpler and uses mostly the same arguments. We choose a closed neighborhood $z_j \in \mathcal{U} \subset \Sigma'$ with biholomorphic embeddings $\psi_k : ([0, \infty) \times S^1, i) \rightarrow (\mathcal{U}, \varphi_k^* j_k)$ converging in $C_{\text{loc}}^\infty([0, \infty) \times S^1, \mathcal{U})$ to $\psi : ([0, \infty) \times S^1, i) \rightarrow (\mathcal{U}, j_\infty)$. Then the J_k -holomorphic half-cylinders

$$\tilde{v}_k = (b_k, v_k) = \tilde{u}_k \circ \varphi_k \circ \psi_k : [0, \infty) \times S^1 \rightarrow \mathbb{R} \times M$$

converge in C_{loc}^∞ to $\tilde{v}_\infty = (b_\infty, v_\infty) = \tilde{u}_\infty \circ \psi : [0, \infty) \times S^1 \rightarrow \mathbb{R} \times M$, and there are uniform energy and gradient bounds for \tilde{v}_k . We also have

$$\lim_{k \rightarrow \infty} \int_{[s_k, \infty)} v_k^* d\lambda_k \rightarrow 0$$

for any sequence $s_k \rightarrow \infty$, using the C_{loc}^∞ -convergence and the fact that each map \tilde{v}_k for $k \leq \infty$ is asymptotic to an orbit in N_j , hence

$$\lim_{k \rightarrow \infty} \lim_{s \rightarrow \infty} \int_{\{s\} \times S^1} v_k^* \lambda_k = \lim_{s \rightarrow \infty} \int_{\{s\} \times S^1} v_\infty^* \lambda_\infty = Q_0.$$

Now for any sequence $s_k \rightarrow \infty$, the translated maps $\tilde{w}_k(s, t) = \tilde{v}_k(s + s_k, t)$ have a subsequence converging in C_{loc}^∞ to a \tilde{J}_∞ -holomorphic cylinder

$$\tilde{w}_\infty = (\beta_\infty, w_\infty) : \mathbb{R} \times S^1 \rightarrow \mathbb{R} \times M$$

with finite energy and zero contact area, which is therefore an orbit cylinder. This shows that a subsequence of $v(s_k, \cdot) = u_k \circ \varphi_k(\psi_k(s_k, \cdot))$ converges in $C^\infty(S^1, M)$ to a loop $y : S^1 \rightarrow M$ which parametrizes an orbit of X_{λ_∞} . If $P = y(S^1) \not\subset N_j$, we define the sets $\mathcal{N} \subset \mathcal{V} \subset \mathcal{V}' \subset C^\infty(S^1, M)$ as before so that \mathcal{N} contains all loops in N_j and $\overline{\mathcal{V}'}$ contains no other orbits of X_{λ_∞} . Then since each half-cylinder $\tilde{v}_k(s, t)$ is asymptotic to an orbit in N_j as $s \rightarrow \infty$, we can find $s'_k > s_k$ such that $v_k(s'_k, \cdot) \in \mathcal{V}' \setminus \mathcal{V}$, leading again to a contradiction. \square

In the case where all asymptotic orbits are nondegenerate, this argument is enough to prove convergence in $\mathcal{M}(\tilde{J}, L)$ (see Definition 4.5.3). Observe that any solution $\tilde{u} : \dot{\Sigma} \rightarrow \mathbb{R} \times M$ of Problem (BP) can be extended to a continuous map $\bar{u} : \bar{\Sigma} \rightarrow \bar{\mathbb{R}} \times M$, where $\bar{\mathbb{R}} = [-\infty, \infty]$.

Theorem 4.6.22. *Let M be a closed 3-manifold with a C^∞ -compact sequence of contact forms $\lambda_k \rightarrow \lambda_\infty$ and admissible complex multiplications $J_k \rightarrow J_\infty$. Suppose $\dot{\Sigma} = \Sigma \setminus \Gamma$ is a fixed compact oriented surface with boundary and finitely many interior punctures, and for $k \in \mathbb{Z} \cup \{\infty\}$ we have \tilde{J}_k -holomorphic solutions $\tilde{u}_k = (a_k, u_k) : \dot{\Sigma} \rightarrow \mathbb{R} \times M$ to Problem (BP), such that*

- (i) $\tilde{u}_k \rightarrow \tilde{u}_\infty$ in $C_{\text{loc}}^\infty(\dot{\Sigma}, \mathbb{R} \times M)$, and
- (ii) for each puncture in Γ , every solution \tilde{u}_k for $k \leq \infty$ has the same nondegenerate asymptotic limit with the same sign.

Then there are diffeomorphisms $\varphi_k : \Sigma \rightarrow \Sigma$, fixing each puncture and preserving each connected component of $\partial\Sigma$, such that for any compact subset $K \subset \dot{\Sigma}$, $\varphi_k|_K = \text{Id}_K$ for sufficiently large k , and if $\bar{\varphi}_k$ denotes the homeomorphism induced on $\bar{\Sigma}$, then

$$\bar{u}_k \circ \bar{\varphi}_k \rightarrow \bar{u}_\infty \quad \text{in } C^0(\bar{\Sigma}, \bar{\mathbb{R}} \times M).$$

In particular, $\tilde{u}_k \rightarrow \tilde{u}_\infty$ in $\mathcal{M}(\tilde{J}, L)$.

Proof. Denote $j_k = \tilde{u}_k^* \tilde{J}_k$, so $j_k \rightarrow j_\infty$ in $C_{\text{loc}}^\infty(\dot{\Sigma})$. Using Lemma 4.6.20, choose at each puncture $z^j \in \Gamma$ a punctured neighborhood $\dot{\mathcal{U}}^j \subset \dot{\Sigma}$ and biholomorphic maps

$$\psi_k^j : ([0, \infty) \times S^1, i) \rightarrow (\dot{\mathcal{U}}^j, j_k)$$

such that $\psi_k^j \rightarrow \psi_\infty^j$ in $C_{\text{loc}}^\infty([0, \infty) \times S^1, \dot{\Sigma})$. Then by the arguments of Theorem 4.6.19, for any sequence $s_k \rightarrow \infty$, the loops $u_k \circ \psi_k^j(s_k, \cdot)$ converge in $C^\infty(S^1, M)$ to a loop $t \mapsto x^j(t + c)$, where $x^j : S^1 \rightarrow M$ is some fixed parametrization of the asymptotic limit at z^j and $c \in S^1$ is a constant that may depend on the choice of sequence s_k . Similarly, the maps $\partial_s(a_k \circ \psi_k^j)(s_k, \cdot)$ converge in $C^\infty(S^1, \mathbb{R})$ to the constant $Q^j \neq 0$, which is the charge of the puncture z^j for \tilde{u}_∞ .

Now choose suitable metrics for $\bar{\mathbb{R}} \times M$ and $C^\infty(S^1, M)$. Then for any $\epsilon > 0$, we can find $k_0 \in \mathbb{N}$ and a compact subset $K \subset \dot{\Sigma}$ such that $\text{dist}(\tilde{u}_k(z), \tilde{u}_\infty(z)) < \epsilon$ for all $k \geq k_0$ and $z \in K$. We can also assume there is a number $s_0 \in (0, \infty)$ such that

- (i) $\dot{\Sigma} = \text{int } K \cup \left(\bigcup_j \psi_k^j([s_0, \infty) \times S^1) \right)$,
- (ii) $\text{dist}(u_k \circ \psi_k^j(s, \cdot), x^j(\cdot + c)) < \epsilon$ for some $c \in S^1$, and
- (iii) $|\partial_s(a_k \circ \psi_k^j)(s, t) - Q^j| < \epsilon$

for all $k \geq k_0$ and $s \geq s_0$. Then it is possible to choose diffeomorphisms $\varphi_k : \Sigma \rightarrow \Sigma$ with

$$\text{supp}(\varphi_k) \subset \bigcup_j \overline{\psi_\infty^j([s_0, \infty) \times S^1)}$$

such that for all $s \geq s_0$ and $k \geq k_0$, $\text{dist}(\tilde{u}_k \circ \varphi_k \circ \psi_\infty^j(s, t), \tilde{u}_\infty \circ \psi_\infty^j(s, t))$ is uniformly small. Repeating this for larger k and smaller ϵ , we obtain a sequence with the desired properties. The statement that $\tilde{u}_k \rightarrow \tilde{u}_\infty$ in $\mathcal{M}(\tilde{J}, L)$ follows since $\tilde{u}_k \circ \varphi_k$ clearly still converges to \tilde{u}_∞ in $C_{\text{loc}}^\infty(\dot{\Sigma}, \mathbb{R} \times M)$. \square

Chapter 5

Modifying Foliations under Surgery

5.1 The main construction

In this chapter we present the proof of Theorem 1.3.2 on the existence of stable finite energy foliations of Morse-Bott type. These foliations live in a closed contact 3-manifold (M, ξ) which is obtained from the tight 3-sphere (S^3, ξ_0) by some combination of Dehn surgery and Lutz twists along a link $K \subset S^3$ transverse to ξ_0 . The details of this surgery were explained in Chapter 2. We begin this chapter by recalling some basic notions, and then describe the procedure for modifying a foliation under surgery. For technical reasons, we will carry out this program first under a restrictive assumption on the link K , and then use a branched cover construction to remove this assumption in Sec. 5.1.5. The argument uses several fundamental compactness results, the proofs of which are presented in Sections 5.2 and 5.3.

5.1.1 Planar open books in the tight three-sphere

Identify S^3 with the unit sphere in \mathbb{C}^2 and define the standard (tight) contact form λ_0 on S^3 in terms of the standard inner product on \mathbb{C}^2 by

$$\lambda_0(z)v := \frac{1}{2}\langle iz, v \rangle,$$

for $z \in S^3 \subset \mathbb{C}^2$ and $v \in T_z S^3 \subset \mathbb{C}^2$. Note that this expression is real even though the inner product is complex. The contact plane $(\xi_0)_z$ at z is the complex orthogonal complement of z in \mathbb{C}^2 , which can also be thought of as the unique complex line in

$T_z S^3$. Every Hopf circle

$$P_w = \{(z_1, z_2) \in S^3 \mid z_1/z_2 = w\} \quad \text{for } w \in \mathbb{C} \cup \{\infty\}$$

is a periodic orbit of X_{λ_0} .

The starting point of our foliation construction is an open book decomposition of (S^3, λ_A, J_A) by finite energy planes for some contact form with $\ker \lambda_A = \xi_0$ and some admissible complex multiplication $J_A : \xi_0 \rightarrow \xi_0$. For example one can take the foliation of (S^3, λ_0, i) from Example 1.2.3 and perturb λ_0 so that the binding orbit P_∞ becomes nondegenerate (see Example 3.2.1).

If one prefers to work with purely nondegenerate contact forms, a popular example is the so-called *irrational ellipsoid*: choose positive numbers r_1, r_2 and define

$$H : \mathbb{C}^2 \rightarrow \mathbb{R} : (z_1, z_2) \mapsto \frac{|z_1|^2}{r_1^2} + \frac{|z_2|^2}{r_2^2}.$$

Let $F_E(z) = 1/H(z)$ for $z \in S^3 \subset \mathbb{C}^2$. Then the Hamiltonian flow determined by H on the energy surface $H^{-1}(1)$ is equivalent to the Reeb flow on $(S^3, F_E \lambda_0)$. If r_1^2/r_2^2 is irrational then this flow has only two periodic orbits, P_0 and P_∞ , both nondegenerate. Assume $r_1 < r_2$: then P_∞ has the smallest period and has Conley-Zehnder index 3. Choose an admissible complex multiplication $J_E : \xi_0 \rightarrow \xi_0$ and define the corresponding almost complex structure \tilde{J}_E on $\mathbb{R} \times S^3$ in terms of $\lambda_E = F_E \lambda_0$ and J_E . Then it follows from the results in [HWZ95b] that for some choice of J_E , (S^3, λ_E, J_E) admits a stable finite energy foliation which is an open book decomposition, all leaves being finite energy planes asymptotic to P_∞ .¹ (See also [HWZ98], where this result is used for a different application.)

Assume the data (λ_A, J_A) come from one of the examples above, such that P_0 and P_∞ are both periodic orbits, $\mu_{CZ}(P_\infty) = 3$ and there is a stable open book decomposition with P_∞ as the binding orbit. Let us state this last fact more precisely, using the notation of Chapter 4.

Proposition 5.1.1. *There exists an embedding*

$$\begin{aligned} \mathbb{R} \times S^1 \times \mathbb{C} &\xrightarrow{\tilde{F}} \mathbb{R} \times S^3 \\ (\sigma, \tau, z) &\longmapsto (a_\tau(z) + \sigma, u_\tau(z)) \end{aligned}$$

such that:

¹The construction of the open book decomposition for (S^3, λ_E, J_E) , which actually follows from a much more general result in [HWZ95b], has been likened to “killing a canary with a hydrogen bomb.” Indeed, given such an explicit construction of a contact form, one would think that the open book decomposition could also be constructed more explicitly, as is the case for instance with the degenerate contact form λ_0 . But no such construction is known.

1. For $\sigma \in \mathbb{R}$ and $\tau \in S^1$, the maps $\tilde{u}_{(\sigma,\tau)} = \tilde{F}(\sigma, \tau, \cdot) : \mathbb{C} \rightarrow \mathbb{R} \times S^3$ are embedded \tilde{J}_A -holomorphic finite energy planes asymptotic to P_∞ .
2. The map $F(\tau, z) = u_\tau(z)$ is a diffeomorphism $S^1 \times \mathbb{C} \rightarrow S^3 \setminus P_\infty$. In particular the maps $u_\tau : \mathbb{C} \rightarrow S^3$ form a foliation of $S^3 \setminus P_\infty$ which is everywhere transverse to X_{λ_A} .

Denote this foliation of $\mathbb{R} \times S^3$ by \mathcal{F}_A , and the projected foliation of $S^3 \setminus P_\infty$ by $p(\mathcal{F}_A)$. We will use the leaves of \mathcal{F}_A to produce foliations on other contact manifolds that are obtained from (S^3, ξ_0) by surgery along transverse links.

Remark 5.1.2. *Technically, the full force of Prop. 5.1.1 is not needed for what follows: we only really need the existence of one of the planes $\tilde{u} : \mathbb{C} \rightarrow \mathbb{R} \times S^3$ that constitute the foliation \mathcal{F}_A . In [HWZ95b], the existence of a single leaf \tilde{u} is proved first, and then the full foliation is constructed by a compactness argument. We will follow a similar approach after modifying the leaf \tilde{u} under surgery.*

For the surgery, choose an arbitrary link $K \subset S^3$, positively transverse to ξ_0 . By Lemma 2.2.1, we can assume after a transverse isotopy that each component of K is C^∞ -close to some positive cover of the Hopf circle P_0 . Since P_0 is a periodic orbit of X_{λ_A} , it is transverse to $p(\mathcal{F}_A)$, and thus we may also assume that K is transverse to $p(\mathcal{F}_A)$.

5.1.2 Simplifying the contact form near a link

The next step is to modify the contact form λ_A (but not the contact structure) so that it matches a simple normal form in a neighborhood of K . If $K_0 \subset K$ is a transverse loop, we can identify a neighborhood of K_0 with $S^1 \times B_\epsilon^2(0)$, where $B_\epsilon^2(0) \subset \mathbb{R}^2$ is a small ball containing 0, and use coordinates $(\theta, \rho, \phi) \in S^1 \times B_\epsilon^2(0)$ so that $K_0 = \{\rho = 0\}$ and $\lambda_A = h(\theta, \rho, \phi)(d\theta + \rho^2 d\phi)$ for some smooth function h . Here (ρ, ϕ) are polar coordinates on \mathbb{R}^2 . In the following, the use of coordinates (θ, ρ, ϕ) will always mean an identification of this type.

It would be preferable to simplify λ_A so that its coordinate expression depends only on ρ ; we could then write it in the form $\lambda_B = f(\rho)d\theta + g(\rho)d\phi$ as in Chapter 3. In principle we can achieve this change in λ_A by a smooth homotopy and use Theorem 4.5.51 to homotop the foliation \mathcal{F}_A correspondingly—but the change must be made carefully so as to preserve compactness. We will see that it suffices to make sure the change is C^1 -small, and confined to a neighborhood of K . For this we take advantage of the fact that each component of K is C^∞ -close to a positive cover of the closed orbit P_0 .

Let us frame this in a more general setting. Suppose (M, λ) is a closed contact 3-manifold, $\xi = \ker \lambda$, and $P \subset M$ is a periodic orbit of X_λ with period T . Choose a parametrization $x : \mathbb{R}/T\mathbb{Z} \rightarrow M$ of P satisfying $\dot{x}(t) = X_\lambda(x(t))$. Suppose $K = K_1 \cup \dots \cup K_N \subset M$ is a link with each component close to a positive cover of P , in the sense of Lemma 2.2.1. More precisely, there are smooth families $\gamma_j^\tau : S^1 \rightarrow M$ for $\tau \in [0, 1]$ such that $\gamma_j^1(S^1) = K_j$, $\gamma_j^0(t) = x(k_j T t)$ for some $k_j \in \mathbb{N}$, and for each fixed $\tau \in (0, 1]$, the maps $\gamma_1^\tau, \dots, \gamma_N^\tau : S^1 \rightarrow M$ are mutually non-intersecting embeddings transverse to ξ . Denote $K_j^\tau = \gamma_j^\tau(S^1)$ and $K^\tau = K_1^\tau \cup \dots \cup K_N^\tau$ for $\tau \in (0, 1]$.

Proposition 5.1.3. *Given the assumptions above, one can choose τ small enough so that there is a contact form λ' on M with $\ker \lambda' = \xi = \ker \lambda$ and the following properties:*

- (i) λ' is C^1 -close to λ , and differs from λ only in an arbitrarily small neighborhood of K^τ ,
- (ii) near each of the knots K_j^τ there is a coordinate system (θ, ρ, ϕ) in which $K_j^\tau = \{\rho = 0\}$ and $\lambda' = c(d\theta + \rho^2 d\phi)$ for some constant c .

Remark 5.1.4. *The first property implies that $X_{\lambda'}$ is C^0 -close to X_λ , and equal to it away from K^τ . In the case of λ_A on S^3 , this means we can assume the perturbed Reeb vector field X_{λ_B} is still transverse to \mathcal{F}_A . This has the advantage that, while changing λ_A sacrifices our precise knowledge of its periodic orbits, we can at least conclude from the structure of the open book decomposition that any new periodic orbits for λ_B must be linked nontrivially with P_∞ . This will be crucial for the compactness arguments to follow.*

The key to proving Prop. 5.1.3 is to construct a coordinate system in which λ already *almost* has the desired property, and then perturb λ . Choose an admissible complex structure J on ξ , and let g be the metric on M defined by the conditions that X_λ is a unit vector orthogonal to ξ and $g|_\xi = d\lambda(\cdot, J\cdot)$. Choose a neighborhood $\mathcal{U} \subset M$ which is retractable to P . Then the complex line bundle $\xi \rightarrow M$ is trivial over \mathcal{U} , so we can choose a nonzero section $v : \mathcal{U} \rightarrow \xi$ such that $d\lambda(v, Jv) \equiv 1$; the vector fields $\{X_\lambda, v, Jv\}$ form an orthonormal frame for TM over \mathcal{U} . We may assume without loss of generality that $K^\tau \subset \mathcal{U}$ for all $\tau \in (0, 1]$. Since the knots K_j^τ are assumed transverse to ξ , we can choose the parametrizations $\gamma_j^\tau : S^1 \rightarrow M$ so that $\lambda(\dot{\gamma}_j^\tau(t))$ is independent of t (it is positive and depends smoothly on τ).

Lemma 5.1.5. *For each component $K_j \subset K$, there is a ball $B_\delta^2(0) \subset \mathbb{R}^2$ around 0 and a smooth family of immersions $\psi_j^\tau : S^1 \times B_\delta^2(0) \rightarrow M$, $\tau \in [0, 1]$, such that $\psi_j^\tau(\theta, 0) = \gamma_j^\tau(\theta)$ for all $\theta \in S^1$, and $(\psi_j^\tau)^*\lambda = h_j^\tau(\theta, \rho, \phi)(d\theta + \rho^2 d\phi)$ for some smooth family of real-valued functions h_j^τ , which are constant on $S^1 \times \{0\}$.*

Proof. For each individual τ this follows from a standard Moser deformation argument; one must however make sure that the result depends smoothly on the parameter τ .

Write $c^\tau = \lambda(\dot{\gamma}_j^\tau(t))$, recalling that this number is independent of t . Let (x, y) be the Cartesian coordinates on \mathbb{R}^2 corresponding to the polar coordinates (ρ, ϕ) . For each $\tau \in [0, 1]$ and some $r > 0$, there is an immersion $\Psi^\tau : S^1 \times B_r^2(0) \rightarrow M$ defined by

$$\Psi^\tau(\theta, x, y) = \exp_{\gamma_j^\tau(\theta)} \left(\sqrt{2c^\tau} (x \cdot v(\gamma_j^\tau(\theta)) + y \cdot Jv(\gamma_j^\tau(\theta))) \right). \quad (5.1.1)$$

The exponential map here is defined in terms of the metric g . Clearly $\Psi^\tau(\theta, x, y)$ depends smoothly on τ , and for any $\tau > 0$ its restriction to some neighborhood of $S^1 \times \{0\}$ is an embedding (since $\Psi^\tau(\cdot, 0, 0) = \gamma_j^\tau$ is embedded). Denote $\alpha_1^\tau = (\Psi^\tau)^*\lambda$, and define another smooth family of contact forms on $S^1 \times B_r^2(0)$ by $\alpha_0^\tau = c^\tau(d\theta + \rho^2 d\phi) = c^\tau(d\theta - ydx + xdy)$. The contact structure $\zeta_0 = \ker \alpha_0^\tau$ is independent of τ . For any $(\theta, 0, 0) \in S^1 \times \{0\} \subset S^1 \times B_r^2(0)$ we have

$$\begin{aligned} \partial_\theta \Psi^\tau(\theta, 0, 0) &= \dot{\gamma}_j^\tau(\theta), \\ \partial_x \Psi^\tau(\theta, 0, 0) &= \sqrt{2c^\tau} \cdot v(\gamma_j^\tau(\theta)), \\ \partial_y \Psi^\tau(\theta, 0, 0) &= \sqrt{2c^\tau} \cdot Jv(\gamma_j^\tau(\theta)). \end{aligned}$$

A short computation then shows that α_0^τ and α_1^τ are related to each other along $S^1 \times \{0\}$ by $\alpha_0^\tau \equiv \alpha_1^\tau$ and $d\alpha_0^\tau|_{\zeta_0} \equiv d\alpha_1^\tau|_{\zeta_0}$.

Define a smooth family of 1-forms $\alpha_t^\tau = (1-t)\alpha_0^\tau + t\alpha_1^\tau$, for $t \in [0, 1]$, $\tau \in [0, 1]$. On $S^1 \times \{0\}$, $d\alpha_t^\tau|_{\zeta_0} = (1-t)d\alpha_0^\tau|_{\zeta_0} + td\alpha_1^\tau|_{\zeta_0} = d\alpha_0^\tau|_{\zeta_0}$ is nondegenerate, thus nondegeneracy holds also in a neighborhood of $S^1 \times \{0\}$, and we can assume by shrinking $B_r^2(0)$ if necessary that α_t^τ is a contact form on $S^1 \times B_r^2(0)$ for all t and τ . The goal is now to find a smooth family of diffeomorphisms φ_t^τ between neighborhoods of $S^1 \times \{0\}$ such that $(\varphi_t^\tau)^*\alpha_t^\tau = f_t^\tau \alpha_0^\tau$ for some smooth family of real-valued functions f_t^τ . We proceed by assuming that for each τ , the family φ_t^τ can be constructed as the flow generated by a time-dependent vector field Y_t^τ :

$$\frac{\partial}{\partial t} \varphi_t^\tau(p) = Y_t^\tau(\varphi_t^\tau(p)).$$

We will derive the properties that Y_t^τ must satisfy, then verify that such a flow exists on a neighborhood of $S^1 \times \{0\}$ and depends smoothly on τ . It will turn out that we can assume Y_t^τ takes values in $\zeta_t^\tau = \ker \alpha_t^\tau$. Denote $\dot{f}_t^\tau = \frac{\partial}{\partial t} f_t^\tau$ and $\dot{\alpha}_t^\tau = \frac{\partial}{\partial t} \alpha_t^\tau$. Then if there is a flow φ_t^τ satisfying $(\varphi_t^\tau)^*\alpha_t^\tau = f_t^\tau \alpha_0^\tau$, we have

$$\frac{\partial}{\partial t} (\varphi_t^\tau)^*\alpha_t^\tau = (\varphi_t^\tau)^* (L_{Y_t^\tau} \alpha_t^\tau + \dot{\alpha}_t^\tau) = \dot{f}_t^\tau \alpha_0^\tau = \frac{\dot{f}_t^\tau}{f_t^\tau} (\varphi_t^\tau)^*\alpha_t^\tau = (\varphi_t^\tau)^*(F_t^\tau \alpha_t^\tau),$$

where

$$F_t^\tau := \frac{\dot{f}_t^\tau}{f_t^\tau} \circ (\varphi_t^\tau)^{-1} = \left[\frac{\partial}{\partial t} (\ln f_t^\tau) \right] \circ (\varphi_t^\tau)^{-1}.$$

Using $Y_t^\tau \in \zeta_t^\tau$, we then compute $L_{Y_t^\tau} \alpha_t^\tau + \dot{\alpha}_t^\tau = \iota_{Y_t^\tau} d\alpha_t^\tau + \dot{\alpha}_t^\tau = F_t^\tau \alpha_t^\tau$. Evaluating this on ζ_t^τ and $X_{\alpha_t^\tau}$ respectively yields two equations,

$$d\alpha_t^\tau(Y_t^\tau, \cdot)|_{\zeta_t^\tau} = -\dot{\alpha}_t^\tau|_{\zeta_t^\tau} \quad \text{and} \quad \dot{\alpha}_t^\tau(X_{\alpha_t^\tau}) = F_t^\tau,$$

which determine Y_t^τ and F_t^τ uniquely. Observe that both depend smoothly on τ ; the same will therefore be true of the flow φ_t^τ . On $S^1 \times \{0\}$, $\dot{\alpha}_t^\tau = \alpha_1^\tau - \alpha_0^\tau = 0$, so $Y_t^\tau = 0$ there, implying that the flow does exist on some neighborhood of $S^1 \times \{0\}$, and fixes $S^1 \times \{0\}$ itself. Now define f_t^τ by

$$f_t^\tau = \exp \left(\int_0^t g_s^\tau \circ \phi_s^\tau ds \right). \quad (5.1.2)$$

This also depends smoothly on τ . With these definitions, it is routine to verify that $\frac{\partial}{\partial t} (\varphi_t^\tau)^* \alpha_t^\tau = (\varphi_t^\tau)^* (F_t^\tau \alpha_t^\tau) = \frac{\dot{f}_t^\tau}{f_t^\tau} (\varphi_t^\tau)^* \alpha_t^\tau$, and thus

$$(\varphi_t^\tau)^* \alpha_t^\tau = \exp \left(\int_0^t \frac{\dot{f}_s^\tau}{f_s^\tau} ds \right) \alpha_0^\tau = f_t^\tau \alpha_0^\tau.$$

In particular, setting $\varphi^\tau := \varphi_1^\tau$, we have $(\varphi^\tau)^* \alpha_1^\tau = f_1^\tau \alpha_0^\tau = c^\tau f_1^\tau (d\theta + \rho^2 d\phi)$, and thus

$$(\Psi^\tau \circ \varphi^\tau)^* \lambda = (\varphi^\tau)^* (\Psi^\tau)^* \lambda = (\varphi^\tau)^* \alpha_1^\tau = c^\tau f_1^\tau (d\theta + \rho^2 d\phi).$$

Observe that $F_t^\tau(\theta, 0, 0) = 0$ and $\varphi^\tau(\theta, 0, 0) = (\theta, 0, 0)$, thus (5.1.2) gives $f_1^\tau(\theta, 0, 0) = 1$ for all θ . So the desired family of immersions is $\psi_j^\tau = \Psi^\tau \circ \varphi^\tau$, with $h_j^\tau = c^\tau f_1^\tau$. \square

Proof of Prop. 5.1.3. We'll use the immersions $\psi_j^\tau : S^1 \times B_\delta^2(0) \rightarrow M$ constructed in Lemma 5.1.5 to define a family of contact forms λ^τ in coordinates such that $\lambda^\tau \rightarrow \lambda$ in C^1 as $\tau \rightarrow 0$.

Choose numbers $\rho^\tau \in (0, \delta]$, smoothly dependent on the parameter τ , such that $\rho^\tau \rightarrow 0$ as $\tau \rightarrow 0$ and for each $\tau \in (0, 1]$ the maps ψ_j^τ restricted to $S^1 \times B_{\rho^\tau}^2(0)$ are embeddings with mutually disjoint images. Choose also a smooth function $\beta : [0, 1] \rightarrow [0, 1]$ such that $\beta(s) = 0$ for s near 0, $\beta(s) = 1$ for s near 1 and $|\beta'(s)| < 2$ for all $s \in [0, 1]$. Recall that there are smooth functions h_j^τ such that $(\psi_j^\tau)^* \lambda = h_j^\tau(\theta, \rho, \phi)(d\theta + \rho^2 d\phi)$, and $c_j^\tau := h_j^\tau(\theta, 0)$ is independent of θ .

For $\tau > 0$, define λ^τ to be the unique contact form on M such that

- (i) $\lambda^\tau = \lambda$ outside of $\bigcup_{j=1}^N \psi_j^\tau(S^1 \times B_{\rho^\tau}^2(0))$, and

(ii) $(\psi_j^\tau)^* \lambda^\tau = \tilde{h}_j^\tau(\theta, \rho, \phi)(d\theta + \rho^2 d\phi)$ on $S^1 \times B_{\rho^\tau}^2(0)$, where

$$\tilde{h}_j^\tau(\theta, \rho, \phi) = (1 - \beta(\rho/\rho^\tau))c_j^\tau + \beta(\rho/\rho^\tau)h_j^\tau(\theta, \rho, \phi).$$

We claim that $\lambda^\tau \rightarrow \lambda$ in C^1 as $\tau \rightarrow 0$. Noting that there are functions f^τ such that $\lambda^\tau = f^\tau \lambda$, it is sufficient to prove that $f^\tau \rightarrow 1$ and $|\nabla f^\tau|_g \rightarrow 0$, both uniformly on M . Since f^τ already equals 1 outside of the local coordinate neighborhoods, we only need check that $\sup |\tilde{h}_j^\tau - h_j^\tau| \rightarrow 0$ and $\sup |\nabla \tilde{h}_j^\tau - \nabla h_j^\tau|_{(\psi_j^\tau)^*g} \rightarrow 0$, where both suprema are taken over the domain $S^1 \times B_{\rho^\tau}^2(0)$. We can work with a fixed metric since $(\psi_j^\tau)^*g \rightarrow (\psi_j^0)^*g$ uniformly on $S^1 \times B_\delta^2(0)$. Moreover, any fixed metric on $S^1 \times B_\delta^2(0)$ is equivalent to any other one, so we may as well choose the natural metric defined by the coordinates (θ, x, y) ; then $|\nabla h|$ simply means the Euclidean length of the vector $(\partial_\theta h, \partial_x h, \partial_y h)$ in \mathbb{R}^3 .

What makes the gradient estimate possible is the fact that the loops $\psi_j^\tau(S^1 \times \{0\})$ converge to periodic orbits as $\tau \rightarrow 0$, and consequently $\nabla h_j^0(\theta, 0) = 0$. To see this, use Cartesian coordinates (θ, x, y) and compute

$$\begin{aligned} (\psi_j^\tau)^* d\lambda &= d[h_j^\tau(\theta, x, y)(d\theta - ydx + xdy)] \\ &= [2h_j^\tau(\theta, x, y) + x \partial_x h_j^\tau(\theta, x, y) + y \partial_y h_j^\tau(\theta, x, y)] dx \wedge dy \\ &\quad + [-\partial_x h_j^\tau(\theta, x, y) - y \partial_\theta h_j^\tau(\theta, x, y)] d\theta \wedge dx \\ &\quad + [-\partial_y h_j^\tau(\theta, x, y) + x \partial_\theta h_j^\tau(\theta, x, y)] d\theta \wedge dy \end{aligned}$$

From this we see

$$\begin{aligned} \partial_x h_j^\tau(\theta, 0, 0) &= -d\lambda(\partial_\theta \psi_j^\tau(\theta, 0, 0), \partial_x \psi_j^\tau(\theta, 0, 0)), \\ \partial_y h_j^\tau(\theta, 0, 0) &= -d\lambda(\partial_\theta \psi_j^\tau(\theta, 0, 0), \partial_y \psi_j^\tau(\theta, 0, 0)). \end{aligned}$$

Both vanish for $\tau = 0$ since $\partial_\theta \psi_j^0(\theta, 0, 0)$ is parallel to X_λ . It follows that

$$\sup_{\rho \in [0, \rho^\tau]} |\nabla h_j^\tau(\theta, \rho, \phi)| \rightarrow 0$$

as $\tau \rightarrow 0$, and thus

$$\frac{1}{\rho^\tau} \sup_{\rho \in [0, \rho^\tau]} |c_j^\tau - h_j^\tau(\theta, \rho, \phi)| \leq \sup_{\rho \in [0, \rho^\tau]} |\nabla h_j^\tau(\theta, \rho, \phi)| \rightarrow 0.$$

Now we write $\tilde{h}_j^\tau(\theta, \rho, \phi) - h_j^\tau(\theta, \rho, \phi) = (1 - \beta(\rho/\rho^\tau))(c_j^\tau - h_j^\tau(\theta, \rho, \phi))$ and use the fact that $\beta(\rho/\rho^\tau) \in [0, 1]$ to estimate,

$$\left| \tilde{h}_j^\tau(\theta, \rho, \phi) - h_j^\tau(\theta, \rho, \phi) \right| \leq |c_j^\tau - h_j^\tau(\theta, \rho, \phi)| \leq \rho^\tau \sup_{\rho \in [0, \rho^\tau]} |\nabla h_j^\tau(\theta, \rho, \phi)| \rightarrow 0,$$

and using the assumption $|\beta'(\rho/\rho^\tau)| < 2$,

$$\begin{aligned} & |\nabla \tilde{h}_j^\tau(\theta, \rho, \phi) - \nabla h_j^\tau(\theta, \rho, \phi)| \\ & \leq \left| \frac{\beta'(\rho/\rho^\tau)}{\rho^\tau} \right| |c_j^\tau - h_j^\tau(\theta, \rho, \phi)| + |1 - \beta(\rho/\rho^\tau)| |\nabla h_j^\tau(\theta, \rho, \phi)| \\ & \leq 3 \sup_{\rho \in [0, \rho^\tau]} |\nabla h_j^\tau(\theta, \rho, \phi)| \rightarrow 0. \end{aligned}$$

This proves the claim that $\lambda^\tau \rightarrow \lambda$ uniformly to first order. We are now done: choosing $(\psi_j^\tau)^{-1}$ as a coordinate chart near K_j^τ , there is a radius $\rho_0 \in (0, \rho^\tau)$ such that $\beta(\rho/\rho^\tau) = 0$ for all $\rho \leq \rho_0$, thus within this radius we have the coordinate expression $(\psi_j^\tau)^* \lambda^\tau = c_j^\tau(d\theta + \rho^2 d\phi)$. \square

Applying Prop. 5.1.3 to the contact form λ_A on S^3 with transverse link $K \subset S^3$, we find a C^1 -close contact form $\lambda_B = f\lambda_A$ for some smooth function $f : S^3 \rightarrow \mathbb{R}$, such that λ_B looks like $c_j(d\theta + \rho^2 d\phi)$ in coordinates near each component $K_j \subset K$, and $\lambda_B = \lambda_A$ outside a neighborhood of K .

Now choose a smooth family of functions $\{f_r\}_{r \in \mathbb{R}}$ such that $f_r \equiv 1$ for $r \leq 0$ and $f_r \equiv f$ for $r \geq 1$; this defines a smooth homotopy of contact forms $\lambda_r = f_r \lambda_A$ from λ_A to λ_B , all defining the standard contact structure ξ_0 . In light of Remark 5.1.4, we may assume that the Reeb vector fields X_{λ_r} are all transverse to the leaves of the open book decomposition $p(\mathcal{F}_A)$, and that P_∞ is a periodic orbit for all of them. In particular, this means every periodic orbit of X_{λ_r} is nontrivially linked with P_∞ . This turns out to be precisely the condition needed to prove compactness for our moduli spaces of embedded holomorphic curves.

We can similarly homotop the complex structure on ξ_0 to a more convenient form.

Definition 5.1.6. *Suppose (M, λ) is a contact 3-manifold with contact structure $\xi = \ker \lambda$, and $K \subset M$ is a positively transverse knot with a neighborhood that admits coordinates (θ, ρ, ϕ) in which*

$$K = \{\rho = 0\} \quad \text{and} \quad \lambda = f(\rho)d\theta + g(\rho)d\phi$$

for some smooth functions f and g . We say that an admissible complex multiplication $J : \xi \rightarrow \xi$ is adapted to the coordinates (θ, ρ, ϕ) if

1. $d\rho(J\partial_\rho) = 0$, and
2. J is invariant with respect to all rotations $(\theta, \rho, \phi) \mapsto (\theta + c, \rho, \phi)$ and $(\theta, \rho, \phi) \mapsto (\theta, \rho, \phi + c)$

Equivalently, J is adapted to (θ, ρ, ϕ) if and only if it can be defined as in Chapter 3 by $Jv_1 = \beta(\rho)v_2$, where $\{v_1, v_2\}$ is a rotation-invariant frame for $\xi|_{\{\rho>0\}}$ with $v_1 = \partial_\rho$, and $\beta(\rho)$ is a smooth function. We need to convert the complex structure on ξ_0 into precisely this form so that eventually the results of Chapter 3 can be applied for a neighborhood of K . Thus choose some $J_B : \xi_0 \rightarrow \xi_0$ that is adapted to the given coordinates (θ, ρ, ϕ) near each component $K_j \subset K$, and choose a smooth homotopy of complex multiplications

$$J_r : \xi_0 \rightarrow \xi_0$$

such that $J_r = J_A$ for all $r \leq 0$ and $J_r = J_B$ for all $r \geq 1$. Associated with λ_r and J_r , there is a natural smooth family of almost complex structures \tilde{J}_r on $\mathbb{R} \times M$.

Let us now adopt the notation of Sec. 4.5.7 and call \mathcal{M}_0^* the connected moduli space consisting of the finite energy planes in the open book decomposition \mathcal{F}_A . (By Lemma 4.5.50, any embedded finite energy plane in the same connected component of the moduli space must be part of the foliation.) There is a larger connected moduli space \mathcal{M}^* which consists of pairs (r, \tilde{u}) where \tilde{u} is an embedded \tilde{J}_r -holomorphic finite energy plane, and \mathcal{M}_0^* has a natural inclusion into \mathcal{M}^* . Since any $\tilde{v} = (b, v) \in \mathcal{M}_r^*$ is homotopic to some $\tilde{u} = (a, u) \in \mathcal{M}_0^*$, it also satisfies the conditions of Theorem 4.5.44: in particular $v : \mathbb{C} \rightarrow S^3$ is an embedding transverse to X_{λ_r} , and the space of nearby planes in \mathcal{M}_r^* foliates both a neighborhood of $\tilde{v}(\mathbb{C})$ in $\mathbb{R} \times S^3$ and a neighborhood of $v(\mathbb{C})$ in $S^3 \setminus P_\infty$.

Theorem 5.1.7. $\mathcal{M}_{[0,1]}^*/\mathbb{R}$ is compact.

Combining this with Theorem 4.5.51 yields:

Corollary 5.1.8. *There are stable open book decompositions \mathcal{F}_r asymptotic to P_∞ corresponding to the data (S^3, λ_r, J_r) for each $r \in [0, 1]$. In particular, Prop. 5.1.1 holds when (λ_A, J_A) is replaced by (λ_B, J_B) .*

Theorem 5.1.7 follows from a more general compactness result, which we postpone until Sec. 5.2 since it will have wider application. For now, let us simply note that all solutions $\tilde{u} \in \mathcal{M}_r^*$ have the same energy

$$E_r(\tilde{u}) = \sup_{\varphi \in \mathcal{T}_0} \int_{\mathbb{C}} \tilde{u}^* d(\varphi \lambda_r),$$

independent of r and \tilde{u} . That's because the asymptotic behavior and Stokes' theorem imply that this energy is always equal to the period of the orbit P_∞ . See also Prop. 5.1.16, of which this may be considered a special case.

Remark 5.1.9. *Since each solution $\tilde{u} \in \mathcal{M}_r^*$ has only the nondegenerate asymptotic limit P_∞ , convergence in \mathcal{M}^* follows from convergence in $C_{\text{loc}}^\infty(\dot{\Sigma}, \mathbb{R} \times M)$, up to parametrization and \mathbb{R} -translation. This follows from Theorem 4.6.22, and permits us to reduce the question of compactness in $\mathcal{M}_{[0,1]}^*/\mathbb{R}$ to one of finding C_{loc}^∞ -convergent subsequences. Similar remarks apply to the next two compactness results, Theorems 5.1.12 and 5.1.15.*

5.1.3 An open book decomposition with boundary

From the results of the previous section, the situation is now as follows. We have a contact form λ on S^3 , whose kernel is the standard contact structure ξ_0 , and an admissible $J : \xi_0 \rightarrow \xi_0$ such that (S^3, λ, J) admits an open book decomposition \mathcal{F} as in Prop. 5.1.1, consisting of \mathbb{R} -invariant families of embedded finite energy planes $\tilde{u}_{(\sigma,\tau)} : (\mathbb{C}, i) \rightarrow (\mathbb{R} \times S^3, \tilde{J})$. All leaves are asymptotic to the nondegenerate periodic orbit P_∞ with $\mu_{\text{CZ}}(P_\infty) = 3$, and the projected foliation $p(\mathcal{F})$ of $S^3 \setminus P_\infty$ is transverse to X_λ . Most importantly, there is a positively transverse link $K \subset S^3$, presented as a closed braid about P_∞ and living in a neighborhood of P_0 , such that each component $K_j \subset K$ has the following property: a neighborhood of K_j admits a coordinate system (θ, ρ, ϕ) in which $K_j = \{\rho = 0\}$, $\lambda = c_j(d\theta + \rho^2 d\phi)$ for some constant $c_j > 0$, and $J : \xi_0 \rightarrow \xi_0$ is adapted to the coordinates (θ, ρ, ϕ) . Notice that λ is horribly degenerate: every point near K belongs to a periodic orbit, which can be parametrized in coordinates by $(\theta(t), \rho(t), \phi(t)) = (ct, \rho_0, \phi_0)$ for some constants c, ρ_0 and ϕ_0 . A useful consequence of this observation is that each plane $\tilde{u}_{(\sigma,\tau)}$ is transverse to the coordinate vector field ∂_θ as it cuts through a neighborhood of K_j .

In order to perform surgery along K without killing the holomorphic curves, we must convert \mathcal{F} into a stable open book decomposition with boundary (cf. Sec. 4.5.7), so that the pages do not pass through the region we intend to cut out. To that end, choose $\rho_0 > 0$ sufficiently small, and for each component $K_j \subset K$, define a torus around K_j by $L_j = \{\rho = \rho_0\}$. In principle, the intention is now to define families of totally real submanifolds $\tilde{L}_j^\sigma \subset \mathbb{R} \times S^3$ covering L_j , which can be used as boundary conditions for the pages $\tilde{u} \in \mathcal{F}$ after cutting some disks out of the domain \mathbb{C} . In practice, it is complicated to do this for all pages at once and preserve compactness; as we saw in Sec. 4.6, we'll need to assume that the submanifolds \tilde{L}_j^σ are pseudo-Lagrangian. This is a strong condition, and it will force us temporarily to throw out all but one page of the open book \mathcal{F} , reconstructing a foliation only after the boundary condition has been simplified. We also need to make a simplifying assumption which will be in effect for the next several steps in the argument.

Assumption: each connected component $K_j \subset K$ satisfies $\text{lk}(K_j, P_\infty) = 1$.

Here $\text{lk}(K_j, P_\infty)$ denotes the linking number of K_j and P_∞ as oriented knots in S^3 ; in general this could be any natural number. The condition means that each string in the closed braid representing K corresponds to a unique connected component of K , i.e. there is no component that wraps around more than once without repetition. As a result, each page $\tilde{u}_{(\sigma, \tau)}$ of the open book decomposition intersects each component of K exactly once. We will first prove the main result under this assumption, and then use a branched cover construction in Sec. 5.1.5 to generalize the result.

Recall that if $G_j^\sigma : L_j \rightarrow \mathbb{R}$ is a family of smooth functions and \tilde{L}_j^σ is defined as the graph

$$\tilde{L}_j^\sigma = \{(G_j^\sigma(x), x) \in \mathbb{R} \times M \mid x \in L_j\},$$

then \tilde{L}_j^σ is pseudo-Lagrangian if and only if $dG_j^\sigma(X_\lambda) \equiv 0$. Using the coordinates (θ, ϕ) on L_j , this means in the present situation that $G_j^\sigma(\theta, \phi)$ depends only on ϕ . Now choose any page $\tilde{u} = (a, u) = \tilde{u}_{(\sigma_0, \tau_0)} \in \mathcal{F}$ and let $G_j^0 : L_j \rightarrow \mathbb{R}$ be the unique function such that

$$dG_j^0(X_\lambda) \equiv 0 \quad \text{and} \quad G_j^0(u(z)) = a(z) \text{ for all } z \in u^{-1}(L_j).$$

This is possible because \tilde{u} is everywhere transverse to X_λ , and thanks to the simplifying assumption, the intersection of $u(\mathbb{C})$ with L_j has only one component.

We could extend \tilde{L}_j^0 to an \mathbb{R} -invariant family \tilde{L}_j^σ and try to construct an open book decomposition with boundary, but this would be useful only if we could then modify the foliation under homotopies of λ that twist the Reeb vector field near L_j , as will be necessary in the next section. It's difficult to do this and maintain the pseudo-Lagrangian condition unless G_j^σ is constant. The solution is thus to make the family \tilde{L}_j^σ "asymptotically flat" as in Sec. 4.6.2. This will allow us to produce a stable open book decomposition with boundary where the boundary condition is actually Lagrangian.

With this in mind, we extend the functions G_j^0 to a smooth family $G_j^\sigma : L_j \rightarrow \mathbb{R}$ such that

1. $\frac{\partial}{\partial \sigma} G_j^\sigma > 0$.
2. $dG_j^\sigma(X_\lambda) \equiv \frac{\partial}{\partial \theta} G_j^\sigma \equiv 0$.
3. There exists $\sigma_0 > 0$ such that $G_j^\sigma \equiv \sigma$ whenever $|\sigma| \geq \sigma_0$.

In the terminology of Section 4.6.2, this defines an asymptotically flat, pseudo-Lagrangian boundary condition \tilde{L}_j^σ for Problem **(BP)**. We can use the plane $\tilde{u} : \mathbb{C} \rightarrow \mathbb{R} \times S^3$ to produce a single solution to this mixed boundary value problem as follows. Let $N_j \subset S^3$ be the solid torus $\{\rho \leq \rho_0\}$, which contains K_j and has

boundary $\partial N_j = L_j$. By removing the interiors of N_j from S^3 , we obtain a compact 3-manifold $M = S^3 \setminus \bigcup_j (\text{int } N_j)$ with oriented boundary $\partial M = -\bigcup_j L_j$. Since the embedding $u : \mathbb{C} \rightarrow S^3$ is transverse to ∂M , there is a smooth Riemann surface with boundary defined by $(\dot{\Sigma}, j) = (u^{-1}(M), i)$. This is just the complex plane with a finite set of open disks removed; using the natural inclusion $\mathbb{C} \hookrightarrow S^2$ we can also define a compact Riemann surface with boundary, $(\Sigma, j) \subset (S^2, i)$ such that $\dot{\Sigma} = \Sigma \setminus \{\infty\}$. Now the restriction of \tilde{u} to a map $\tilde{v}_0 = (b_0, v_0) : \dot{\Sigma} \rightarrow \mathbb{R} \times M$ is an embedded solution of **(BP)**, satisfying the boundary condition $\tilde{v}_0(\gamma_j) \subset \tilde{L}_j^0 \subset \partial M$ for each component $\gamma_j \subset \partial \Sigma$. The map $v_0 : \dot{\Sigma} \rightarrow M$ is also embedded and transverse to X_λ .

Proposition 5.1.10. $\text{Ind}(\tilde{v}_0) = 2$ and $\text{wind}_\pi(\tilde{v}_0) = 0$.

Proof. The second statement will follow immediately from the first by Equation (4.5.10). To see that the Fredholm index is 2, we observe that \tilde{v}_0 is the restriction of an index 2 finite energy plane $\tilde{u} = (a, u) : \mathbb{C} \rightarrow \mathbb{R} \times S^3$ to a subdomain $\dot{\Sigma} \subset \mathbb{C}$ obtained by removing the finite set of open disks $\mathcal{D}_1 \cup \dots \cup \mathcal{D}_m = \bigcup_j u^{-1}(\text{int } N_j) \subset \mathbb{C}$. Choose a global trivialization of $\xi \rightarrow S^3$; this defines a trivialization Φ of $u^*\xi \rightarrow \mathbb{C}$ for which $\mu_{\text{CZ}}^\Phi(\mathbf{A}_\infty) = \mu_{\text{CZ}}(P_\infty) = 3$, and it also restricts to a trivialization of $v_0^*\xi \rightarrow \dot{\Sigma}$. The generalized Maslov index $\mu(\tilde{v}_0)$ depends on $\mu_{\text{CZ}}^\Phi(\mathbf{A}_\infty)$ as well as the Maslov index of the subbundle $\ell := \xi \cap TL_j$ over each oriented component $\gamma_j = -\partial \overline{\mathcal{D}}_j \subset \partial \Sigma$. We claim $\mu^\Phi(v_0^*\xi|_{\gamma_j}, \ell|_{\gamma_j}) = -2$. Indeed, identifying $\overline{\mathcal{D}}_j$ conformally with the unit disk \mathbb{D} , the restriction of u to $\overline{\mathcal{D}}_j$ is homotopic to a map $w : \mathbb{D} \rightarrow N_j$ expressed in coordinates (θ, ρ, ϕ) by $w(re^{2\pi it}) = (0, \rho_0 r, 2\pi t)$. Moving once around $\partial \mathbb{D}$ with reversed orientation, the intersection $\xi \cap TL_j$ rotates once clockwise with respect to any trivialization that extends over \mathbb{D} ; this gives Maslov index -2 .

The index formula (4.5.5) now yields

$$\begin{aligned} \text{Ind}(\tilde{v}_0) &= \mu(\tilde{u}) + 2(g + m - 1) + \#\Gamma \\ &= [\mu_{\text{CZ}}^\Phi(\mathbf{A}_\infty) - 2m] + 2(m - 1) + 1 = \mu_{\text{CZ}}(P_\infty) - 1 = 2. \end{aligned}$$

□

Remark 5.1.11. *The proof above that $\text{Ind}(\tilde{v}_0) = \text{Ind}(\tilde{u})$ is straightforward but unsatisfying in a certain sense: there are deeper reasons why such a result should hold. One way to see this is by working with the normal Maslov index. Since $u \pitchfork X_\lambda$, one can choose $\{\partial_a, X_\lambda\} \subset T(\mathbb{R} \times S^3)$ as a frame for the normal bundle of \tilde{u} , at least away from the punctures. Using the fact that X_λ is also tangent to each torus L_j , it then becomes obvious that the normal Maslov index at each component of $\partial \Sigma$ is 0, and thus $\mu_N(\tilde{u}) = \mu_N(\tilde{v}_0)$. This is why the Fredholm index calculation doesn't depend on the number of disks removed from S^2 to create Σ .*

By Theorem 4.5.42, \tilde{v}_0 belongs to a smooth 2-parameter family of pairwise disjoint embedded solutions $\{\tilde{v}_\tau\}_{\tau \in B_\varepsilon^2(0)}$ to **(BP)**. The idea is now to consider the maximal extension of this family, and extract from it an open book decomposition with boundary. We will be especially interested in solutions whose boundaries lie outside the region $[-\sigma_0, \sigma_0] \times M$, where the boundary condition is flat and locally \mathbb{R} -invariant. To measure this, pick a connected component $\gamma \subset \partial\Sigma$ and denote

$$m(\tilde{v}) = \max_{z \in \gamma} b(z)$$

for any solution $\tilde{v} = (b, v)$. By Theorem 4.5.42, the existence of any solution \tilde{v} implies the existence of another \tilde{v}' with $m(\tilde{v}') > m(\tilde{v})$. It will now follow from a compactness result that $m(\tilde{v})$ can be made arbitrarily large.

Theorem 5.1.12. *Let $\tilde{v}_k = (b_k, v_k) : \dot{\Sigma} \rightarrow \mathbb{R} \times M$ be a sequence of solutions to the problem defined above, all positively asymptotic to P_∞ at the puncture $\infty \in \Sigma$ and with $v_k|_{\gamma_j} : \gamma_j \rightarrow L_j$ homotopic to $v_0|_{\gamma_j} : \gamma_j \rightarrow L_j$ for each component $\gamma_j \subset \partial\Sigma$. Then there is a sequence of diffeomorphisms $\varphi_k : \Sigma \rightarrow \Sigma$ that fix ∞ and preserve each component of $\partial\Sigma$, such that:*

1. *If $m(\tilde{v}_k)$ is bounded, then a subsequence of $\tilde{v}_k \circ \varphi_k$ converges in C_{loc}^∞ to a solution $\tilde{v}_\infty : \dot{\Sigma} \rightarrow \mathbb{R} \times M$, positively asymptotic to P_∞ at the puncture.*
2. *If $m(\tilde{v}_k)$ is unbounded, then a subsequence of $(b_k - m(\tilde{v}_k), v_k) \circ \varphi_k$ converges in C_{loc}^∞ to a \tilde{J} -holomorphic map $\tilde{w} : \dot{\Sigma} \rightarrow \mathbb{R} \times M$, positively asymptotic to P_∞ at the puncture, and satisfying the boundary condition $\tilde{w}(\gamma_j) \subset \{\text{const}\} \times L_j$ at each component $\gamma_j \subset \partial\Sigma$.*

The convergent subsequence arises from the more general compactness result in Sec. 5.2, and the statement about boundary conditions is a consequence of the uniform gradient bound derived in proving that result. We should note that the discussion of generalized energy in Sec. 4.6 is crucial here. We use the taming set \mathcal{T}_L consisting of functions $\varphi : \mathbb{R} \times S^3 \rightarrow [0, 1]$ that are constant on all of the tori \tilde{L}_j^σ and satisfy the positivity criterion; then Prop. 4.6.15 gives a uniform bound on the energies $E_{\mathcal{T}_L}(\tilde{v}_k)$.

The compactness theorem is applied as follows. Start from $\tilde{v}_0 = (b_0, v_0)$ and construct a sequence $\tilde{v}_k = (b_k, v_k)$ with $m(\tilde{v}_k)$ increasing. Since $v_0 : \dot{\Sigma} \rightarrow M$ is embedded and doesn't intersect P_∞ , we may assume the same is true for all the maps v_k . If $m(\tilde{v}_k)$ is bounded, we find a convergent subsequence $\tilde{v}_k \circ \varphi_k \rightarrow \tilde{v}_\infty = (b_\infty, v_\infty)$ and $m(\tilde{v}_k) \rightarrow m(\tilde{v}_\infty)$.

Proposition 5.1.13. *The map $v_\infty : \dot{\Sigma} \rightarrow M$ is embedded and doesn't intersect P_∞ .*

Proof. Clearly v_∞ is immersed since $\text{wind}_\pi(\tilde{v}_\infty) = \text{wind}_\pi(\tilde{v}_k) = 0$. Then $v_\infty \pitchfork X_\lambda$, and using the fact that $X_\lambda = \partial_\theta$ along L_j and v_∞ maps each component of $\gamma_j \subset \partial\Sigma$ to a meridian on a unique torus L_j , we conclude that v_∞ is injective on the boundary. (Here we're also using the simplifying assumption that each component $K_j \subset K$ is linked only once with P_∞ ; hence v_∞ maps separate components of $\partial\Sigma$ into separate tori.) Now the fact that v_∞ is injective follows from positivity of intersections via Prop. 4.4.13.

An intersection of v_∞ with P_∞ is equivalent to an intersection of \tilde{v}_∞ with the orbit cylinder $\mathbb{R} \times P_\infty$. This is also excluded by positivity of intersections since $\tilde{v}_k(\dot{\Sigma}) \cap \mathbb{R} \times P_\infty = \emptyset$. \square

We can now apply the implicit function theorem again for \tilde{v}_∞ and find more solutions with $m(\tilde{v}) > m(\tilde{v}_\infty)$. Thus we can assume without loss of generality that the sequence \tilde{v}_k satisfies $m(\tilde{v}_k) \rightarrow \infty$. Then the compactness result again gives a solution $\tilde{w} = (\beta, w) : \dot{\Sigma} \rightarrow M$ which satisfies the flat boundary condition $\tilde{w}(\gamma_j) \subset \{\text{const}\} \times L_j$. It has a positive puncture at ∞ asymptotic to P_∞ , and repeating the argument of Prop. 5.1.13, w is also embedded, with image disjoint from P_∞ .

From now on we can dispense with nonstandard taming sets and non-flat boundary conditions: assume $\tilde{L}_j^\sigma = \{\sigma\} \times L_j$, an \mathbb{R} -invariant family of Lagrangian submanifolds, with which we define the boundary conditions for Problem **(BP₀)**. Then $\tilde{w} = (\beta, w)$ is a solution to this problem with $\text{Ind}(\tilde{w}) = 2$. Denote by \mathcal{M} the moduli space of solutions to **(BP₀)**, and let \mathcal{M}^* be the connected component containing \tilde{w} . By the results in Secs. 4.5.6 and 4.5.7, \mathcal{M}^* is a smooth 2-manifold and \mathcal{M}^*/\mathbb{R} is a smooth 1-manifold. Since the asymptotic limits are nondegenerate, C_{loc}^∞ -convergence implies convergence in \mathcal{M}^* (cf. Remark 5.1.9), thus Theorem 5.1.12 implies that \mathcal{M}^*/\mathbb{R} is compact, i.e. it's diffeomorphic to a circle. The main result of this section is the following.

Theorem 5.1.14. *The solutions in \mathcal{M}^* constitute a stable open book decomposition with boundary.*

Proof. There is clearly a diffeomorphism $\psi : S^1 \rightarrow \mathcal{M}^*/\mathbb{R}$ which lifts to a diffeomorphism

$$\tilde{\psi} : \mathbb{R} \times S^1 \rightarrow \mathcal{M}^* : (\sigma, \tau) \mapsto \tilde{w}_{(\sigma, \tau)} = (\beta_\tau + \sigma, w_\tau),$$

with $\tilde{w}_{(0,0)} = \tilde{w}$. This is a slight abuse of notation; β_τ and w_τ are not technically maps on $\dot{\Sigma}$, but rather equivalence classes of maps, up to parametrization. The distinction will be unimportant.

We must first show that $w_\tau : \dot{\Sigma} \rightarrow M$ are all embeddings, and that $w_\tau(\dot{\Sigma}) \cap w_{\tau'}(\dot{\Sigma}) = \emptyset$ if $\tau \neq \tau'$. Both statements are true for τ near 0, by the implicit function

theorem (Thm. 4.5.42). Combining this with Theorem 4.4.4 on self-intersections in the \mathbb{R} -invariant case, we deduce that the subset

$$\{\tilde{w}_{(\sigma,\tau)} \in \mathcal{M}^* \mid w_\tau \text{ is embedded}\}$$

is both open and closed; thus it is all of \mathcal{M}^* . Similarly, the implicit function theorem tells us that for any $\tau \in S^1$, w_τ and $w_{\tau'}$ don't intersect for τ' near τ . Then by Theorem 4.4.5, any convergent sequence $\tilde{w}_{(\sigma_k,\tau_k)}$ for which $w_{\tau_k}(\dot{\Sigma}) \cap w_\tau(\dot{\Sigma}) = \emptyset$ has a limit $\tilde{w}_{(\sigma_\infty,\tau_\infty)}$ for which $w_{\tau_\infty}(\dot{\Sigma})$ is either identical to or disjoint from $w_\tau(\dot{\Sigma})$. The former would imply that $\tilde{w}_{(\sigma_\infty,\tau_\infty)}$ is an \mathbb{R} -translation of $\tilde{w}_{(\sigma,\tau)}$, thus $\tau_\infty = \tau$.

It remains only to show that the family of maps $\{w_\tau\}_{\tau \in S^1}$ covers every point in $M \setminus P_\infty$. Define a subset

$$N = \{p \in M \setminus P_\infty \mid p \in w_\tau(\dot{\Sigma}) \text{ for some } \tau \in S^1\}.$$

By Theorem 4.5.42, N is an open set. We claim that it is also a closed subset of $M \setminus P_\infty$; indeed, suppose $p_k \rightarrow p \in M \setminus P_\infty$ and there are sequences $\tau_k \in S^1$ and $z_k \in \dot{\Sigma}$ such that $w_{\tau_k}(z_k) = p_k$. We may assume after possibly taking a subsequence and reparametrizing that $\tilde{w}_{(\sigma_k,\tau_k)} \rightarrow \tilde{w}_{(\sigma,\tau)}$ in \mathcal{M}^* . In particular, w_{τ_k} and w_τ extend continuously to maps $\bar{w}_{\tau_k}, \bar{w}_\tau : \bar{\Sigma} \rightarrow M$ such that $\bar{w}_{\tau_k} \rightarrow \bar{w}_\tau$ in $C^0(\bar{\Sigma}, M)$. There is also a subsequence such that $z_k \rightarrow z_\infty \in \bar{\Sigma}$, and thus $\bar{w}_{\tau_k}(z_k) \rightarrow \bar{w}_\tau(z_\infty) = p$. Since $p \in M \setminus P_\infty$, we must have $z_\infty \in \dot{\Sigma}$, hence $w_\tau(z) = p$, proving the claim. This shows that N is both open and closed in $M \setminus P_\infty$, hence $N = M \setminus P_\infty$. \square

5.1.4 Twisting the contact structure

Having created a foliation that lives entirely outside of the tori $L_j \subset S^3$, we are now free to make discontinuous changes such as Dehn surgery and Lutz twists to the regions N_j inside these tori. By Remark 2.1.4, it suffices for present purposes to consider Lutz twists. Denote the foliation of Theorem 5.1.14 by \mathcal{F}_K .

Choose a pair of smooth functions $f, g : [0, \rho_0] \rightarrow \mathbb{R}$ with the following properties:

1. $(f(\rho), g(\rho)) = (-1, -\rho^2)$ for ρ near 0
2. $(f(\rho), g(\rho)) = (1, \rho^2)$ for ρ near ρ_0
3. $D(\rho) := f(\rho)g'(\rho) - f'(\rho)g(\rho) > 0$ for all $\rho > 0$
4. $g''(\rho) \neq 0$ whenever $g'(\rho) = 0$

We can then define an overtwisted contact form λ_K on S^3 such that $\lambda_K = \lambda$ in $M \subset S^3$, and in coordinates on N_j ,

$$\lambda_K = c_j [f(\rho)d\theta + g(\rho)d\phi].$$

Focusing on the situation near a particular component $K_j \subset K$, let L_c be the torus $\{\rho = c\}$ for any $c > 0$ sufficiently small. The Reeb vector field in this neighborhood is now

$$X_{\lambda_K}(\theta, \rho, \phi) = \frac{1}{c_j D(\rho)} [g'(\rho)\partial_\theta - f'(\rho)\partial_\phi];$$

at $\rho = \rho_0$ this becomes $\frac{1}{c_j}\partial_\theta$. The torus $L_j = L_{\rho_0}$ is thus foliated by longitudinal periodic orbits, with the boundary of each page $v : \dot{\Sigma} \rightarrow M$ of \mathcal{F}_K cutting through these orbits transversely. As one moves further toward the inside of N_j , the Reeb vector field remains tangent to the tori L_ρ , but its direction twists until it points in the opposite direction at $\rho = 0$. There is thus a radius $\rho_- \in (0, \rho_0)$ such that L_{ρ_-} is foliated by periodic orbits with no ∂_θ -component, i.e. they are meridians. This picture easily suggests what the eventual goal should be: if we shrink the boundary condition for the pages \tilde{v} inward through concentric tori until it reaches L_{ρ_-} , then we can imagine replacing each component of $\partial\Sigma$ by a new puncture, essentially degenerating the missing disk into a missing point. This would produce a foliation of the region outside L_{ρ_-} by finite energy surfaces without boundary, with new punctures asymptotic to periodic orbits on L_{ρ_-} . This is the general idea; in practice however, it's easier to proceed by changing the contact form rather than the boundary condition.

The radius ρ_- is a point in $(0, \rho_0)$ where $g'(\rho_-) = 0$; the existence of such a point is guaranteed by our assumptions on f and g since the path $\rho \mapsto (f(\rho), g(\rho))$ makes at least a half rotation around the origin in \mathbb{R}^2 . (If there's more than one point with $g'(\rho) = 0$, choose ρ_- to be the largest that is less than ρ_0 .) By assumption, $g''(\rho_-) \neq 0$, thus L_{ρ_-} is a simple Morse-Bott manifold, foliated by periodic orbits of the form $x(t) = (\theta_0, \rho_-, ct)$. We shall sometimes refer to these informally as *horizontal* orbits. Now choose $\rho_1 > \rho_0$ and a smooth family of reparametrizations $\psi_r : [0, \rho_1] \rightarrow [0, \rho_1]$, for $r \in [0, 1]$ as shown in Figure 5.1, such that

- (i) ψ_0 is the identity,
- (ii) $\psi_r(\rho) = \rho$ for all ρ near 0 or ρ_1 ,
- (iii) $\psi'_r(\rho) > 0$ for all r and ρ ,
- (iv) $\psi_r(\rho_0) > \rho_-$ for all $r < 1$ and $\psi_1(\rho_0) = \rho_-$.

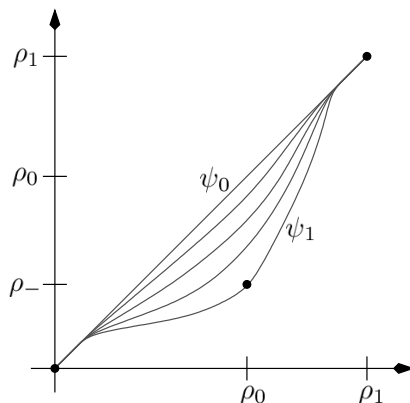

Figure 5.1: The family of reparametrizations $\psi_r : [0, \rho_1] \rightarrow [0, \rho_1]$, $r \in [0, 1]$.

Define a smooth family of contact forms $\{\lambda_r\}_{r \in [0,1]}$ such that in the region $\{\rho \leq \rho_1\}$ near K_j ,

$$\lambda_r = c_j [f(\psi_r(\rho))d\theta + g(\psi_r(\rho))d\phi],$$

and outside of this $\lambda_r = \lambda_K$. (Note that $\lambda_0 = \lambda_K$ everywhere.) It is easily verified that the functions $f_r := f \circ \psi_r$ and $g_r := g \circ \psi_r$ satisfy the same conditions as f and g ; in particular the tori $\{\rho = \psi_r^{-1}(\rho_-)\}$ are simple Morse-Bott manifolds of horizontal orbits for λ_r . Outside of this critical radius the Reeb vector field X_{λ_r} always has a positive ∂_θ -component: in particular this is true for all $\rho \geq \rho_0$ if $r < 1$. One consequence is that for $r < 1$, all periodic orbits of X_{λ_r} in M are still nontrivially linked with P_∞ . For $r = 1$ this is still true in $\text{int } M$, but the boundary $\partial M = \bigcup_j L_j$ is now foliated by horizontal orbits. Figure 5.2 shows the change in the Reeb flow on $L_j = \{\rho = \rho_0\}$ as r approaches 1.

Choose a smooth family of admissible complex multiplications J_r on the contact structures $\xi_r = \ker \lambda_r$ which are adapted to the coordinates (θ, ρ, ϕ) , and define the almost complex structures \tilde{J}_r accordingly. We now ask whether there is a continuous family of open book decompositions \mathcal{F}_r to accompany the homotopy \tilde{J}_r , with $\mathcal{F}_0 = \mathcal{F}_K$. The answer is yes if we move r through $[0, 1)$, but—crucially—compactness must fail as $r \rightarrow 1$. It's easy to see why the latter is true: due to the wind_π estimates, each page of \mathcal{F}_r must be everywhere transverse to X_{λ_r} , but this is impossible at the boundary if all the orbits there are horizontal, since the restriction of a page to each boundary component is also homotopic to a meridian. So if $r \rightarrow 1$, there cannot be a convergent subsequence of \tilde{J}_r -holomorphic solutions homotopic to any page of \mathcal{F}_K . We will find that the only allowed alternative is exactly what we need: each component of $\partial\Sigma$ degenerates to a puncture.

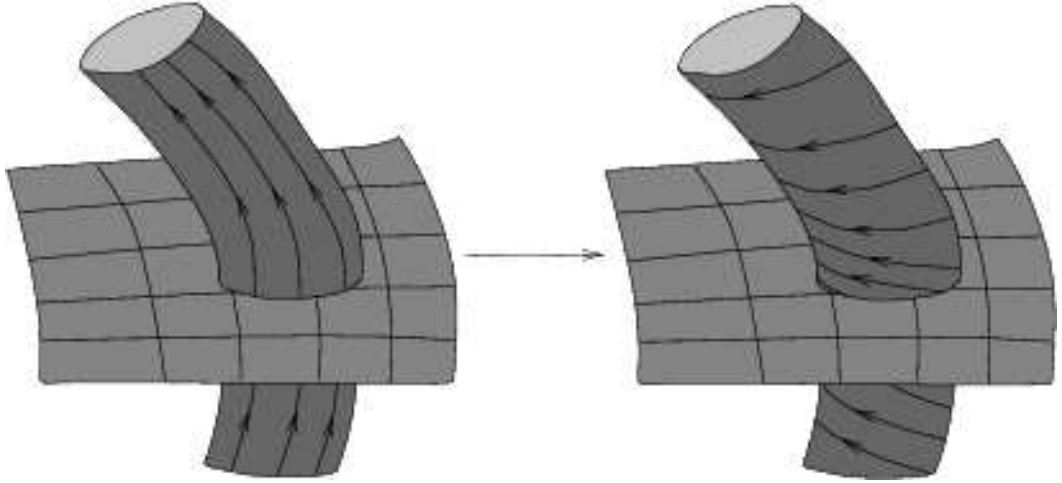

Figure 5.2: The Reeb flow on part of a torus L_j (with a holomorphic curve intersecting transversely) as r approaches 1. Eventually all orbits become meridians.

To formalize this, we once again adopt the notation of Sec. 4.5.7: let \mathcal{M}_0^* be the connected moduli space constituted by the foliation $\mathcal{F}_0 = \mathcal{F}_K$. This is contained in a larger connected moduli space \mathcal{M}^* whose elements are pairs (r, \tilde{v}) , with $\tilde{v} = (b, v) : \dot{\Sigma} \rightarrow \mathbb{R} \times S^3$ a \tilde{J}_r -holomorphic solution of (\mathbf{BP}_0) . Using the natural smooth function $h : \mathcal{M}^* \rightarrow \mathbb{R} : (r, \tilde{v}) \mapsto r$, write $\mathcal{M}_r^* = h^{-1}(r)$ and $\mathcal{M}_{[a,b]}^* = h^{-1}[a, b]$.

Theorem 5.1.15. *For any $r < 1$, $\mathcal{M}_{[0,r]}^*/\mathbb{R}$ is compact.*

As with Theorems 5.1.7 and 5.1.12, this follows from a more general result discussed in Sec. 5.2, which is largely a consequence of the linking condition on periodic orbits of X_{λ_r} . Of course we also need a uniform energy bound:

Proposition 5.1.16. *For all $\tilde{u} = (a, u) \in \mathcal{M}_r^*$ for $r \in [0, 1]$, there is a uniform upper bound (independent of r) on the energy $E_r(\tilde{u})$, defined by*

$$E_r(\tilde{u}) = \sup_{\varphi \in \mathcal{T}_0} \int_{\dot{\Sigma}} \tilde{u}^* d(\varphi \lambda_r), \quad (5.1.3)$$

where \mathcal{T}_0 is the standard taming set $\{\varphi \in C^\infty(\mathbb{R}, [0, 1]) \mid \varphi' \geq 0\}$.

Proof. Let T_∞ be the period of P_∞ . Since $u : \dot{\Sigma} \rightarrow S^3$ approaches P_∞ exponentially fast at the puncture $\infty \in \Sigma$, we have

$$\lim_{R \rightarrow \infty} \int_{\partial \mathbb{D}_R} u^* \lambda_r = T_\infty.$$

Then using Stokes' theorem and the facts that $|\varphi| \leq 1$ for all $\varphi \in \mathcal{T}_0$ and a is locally constant on $\partial\Sigma$,

$$\left| \int_{\dot{\Sigma}} \tilde{u}^* d(\varphi \lambda_r) \right| \leq T_\infty + \left| \int_{\partial\Sigma} \tilde{u}^*(\varphi \lambda_r) \right| \leq T_\infty + \left| \int_{\partial\Sigma} u^* \lambda_r \right|.$$

The 2-forms $d\lambda_r$ vanish on the surfaces L_j , thus applying Stokes' theorem again, the integral on the right for each connected component $\gamma_j \subset \partial\Sigma$ depends only on the homotopy class of $u|_{\gamma_j} : \gamma_j \rightarrow L_j$. Using the coordinates (θ, ρ, ϕ) near L_j , we can therefore let $x : S^1 \rightarrow L_j : t \mapsto (0, \rho_0, -2\pi t)$ and compute,

$$\int_{\gamma_j} u^* \lambda_r = \int_{S^1} x^* \lambda_r = \int_{S^1} \lambda_r(\dot{x}(t)) dt = -2\pi c_j g_r(\rho_0).$$

This is bounded as r varies over $[0, 1]$. □

Taking the compactness result Theorem 5.1.15 as a black box for the moment, we can apply Theorem 4.5.51 once again:

Corollary 5.1.17. *For each $r \in [0, 1)$, there is a stable open book decomposition with boundary \mathcal{F}_r for the data (M, λ_r, J_r) , each with positive binding orbit P_∞ .*

Compactness fails as $r \rightarrow 1$, but as is so often the case with holomorphic curves, this does not in the least mean that interesting things aren't happening.

Theorem 5.1.18. *Let $\tilde{u}_k = (a_k, u_k) \in \mathcal{M}_{r_k}^*$ with $r_k \rightarrow 1$. Then there is a finite set $\Gamma' \subset \mathbb{C}$, a sequence of numbers $c_k \in \mathbb{R}$ and diffeomorphisms $\varphi_k : S^2 \setminus \Gamma' \rightarrow \text{int } \Sigma$ that fix ∞ , such that a subsequence of $(a_k + c_k, u_k) \circ \varphi_k$ converges in $C_{\text{loc}}^\infty(\mathbb{C} \setminus \Gamma', \mathbb{R} \times S^3)$ to a \tilde{J}_1 -holomorphic finite energy surface*

$$\tilde{u} = (a, u) : S^2 \setminus (\{\infty\} \cup \Gamma') \rightarrow \mathbb{R} \times S^3.$$

All the punctures of \tilde{u} are positive, the asymptotic limit at $\infty \in S^2$ is P_∞ , and for each component $\gamma_j \subset \partial\Sigma$ there is a corresponding puncture $z_j \in \Gamma'$ such that the asymptotic limit at z_j is a simply covered horizontal orbit on L_j .

Section 5.3 will be devoted to the proof of this result.

Denote by \mathcal{M}_1^* the space of all finite energy surfaces $\tilde{u} = (a, u) : \mathbb{C} \setminus \Gamma' \rightarrow \mathbb{R} \times S^3$ obtained from Theorem 5.1.18 as limits of solutions in \mathcal{M}_r^* for $r < 1$. Applying now some routine intersection theory, we will show that the curves in \mathcal{M}_1^* form a finite energy foliation of stable Morse-Bott type in $M = S^3 \setminus \bigcup_j \text{int } N_j$.

Proposition 5.1.19. *The moduli space \mathcal{M}_1^* has the following properties.*

- (i) For all $\tilde{u} = (a, u) \in \mathcal{M}_1^*$, $u : \mathbb{C} \setminus \Gamma' \rightarrow \text{int } M$ is an embedding, and $\text{Ind}(\tilde{u}) = 2$.
- (ii) If $\tilde{u} = (a, u) \in \mathcal{M}_1^*$ and $\tilde{v} = (b, v) \in \mathcal{M}_1^*$, then the images of u and v are either identical or disjoint.
- (iii) Every point $p \in \text{int } M$ is in the image of u for some $\tilde{u} = (a, u) \in \mathcal{M}_1^*$.
- (iv) For each component $L_j \subset \partial M$, every horizontal orbit $P \subset L_j$ is an asymptotic limit for a unique \mathbb{R} -invariant set of curves $(a + c, u) \in \mathcal{M}_1^*$, $c \in \mathbb{R}$.

Proof. Using the wind_π estimate of Sec. 4.3 for finite energy surfaces with Morse-Bott asymptotics, one can show that $\text{wind}_\pi(\tilde{u}) = 0$ for all $\tilde{u} = (a, u) \in \mathcal{M}_1^*$; this calculation will be carried out in the proof of Theorem 5.3.1. The key is that the Conley-Zehnder indices at the Morse-Bott limits can be deduced from purely geometric considerations, via Prop. 4.2.12 and Theorem 4.2.14. The same calculation implies $\text{Ind}(\tilde{u}) = 2$.

We conclude that u is immersed. It is also somewhere injective since it has simply covered asymptotic limits. If u fails to be injective, there must be an isolated intersection $\tilde{u}(z_1) = \tilde{u}^c(z_2)$ where $\tilde{u}^c = (a+c, u)$ for some $c \in \mathbb{R}$. Choosing a compact set $K \subset \mathbb{C} \setminus \Gamma'$ that contains both z_1 and z_2 , there is a sequence $\tilde{u}_k = (a_k, u_k) \in \mathcal{M}_{r_k}^*$ for $r_k \rightarrow 1$ and diffeomorphisms $\varphi_k : S^2 \setminus \Gamma' \rightarrow \text{int } \Sigma$ such that $\tilde{u}_k \circ \varphi_k \rightarrow \tilde{u}$ and $\tilde{u}_k^c \circ \varphi_k \rightarrow \tilde{u}^c$ in $C^\infty(K, \mathbb{R} \times M)$. Then by positivity of intersections, there are points ζ_1 near z_1 and ζ_2 near z_2 such that $\tilde{u}_k \circ \varphi_k(\zeta_1) = \tilde{u}_k^c \circ \varphi_k(\zeta_2)$ for some large k , a contradiction since $u_k : \Sigma \rightarrow M$ is injective. This proves (i). The proof of (ii) is almost identical.

To prove (iii), note that for any $p \in \text{int } M$, there is a sequence $\tilde{u}_k = (a_k, u_k) \in \mathcal{M}_{r_k}^*$ with $r_k \rightarrow 1$, unique up to \mathbb{R} -translation and parametrization, such that $p \in u_k(\Sigma)$. Then by Theorem 5.1.18, we can assume there are diffeomorphisms $\varphi_k : S^2 \setminus \Gamma' \rightarrow \text{int } \Sigma$ such that $\tilde{u}_k \circ \varphi_k \rightarrow \tilde{u} = (a, u) \in \mathcal{M}_1^*$ in $C_{\text{loc}}^\infty(\mathbb{C} \setminus \Gamma', \mathbb{R} \times S^3)$. Suppose $z_k \in \mathbb{C} \setminus \Gamma'$ such that $u_k \circ \varphi_k(z_k) = p$. We claim that z_k stays within a compact subset of $\mathbb{C} \setminus \Gamma'$. If not, then a subsequence converges to a puncture, and Theorem 4.6.19 implies that $u_k \circ \varphi_k(z_k)$ converges to either P_∞ or ∂M , a contradiction. Thus we can assume $z_k \rightarrow z_\infty \in \mathbb{C} \setminus \Gamma'$, and $u_k \circ \varphi_k(z_k) \rightarrow u(z_\infty) = p$, proving (iii).

The statement (iv) follows from the implicit function theorem (Thm. 4.5.44) and similar intersection arguments applied to the moduli space $\mathcal{M}(\tilde{J}_1)$ of all \tilde{J}_1 -holomorphic finite energy surfaces contained in M . We claim that \mathcal{M}_1^* is a connected component of $\mathcal{M}(\tilde{J}_1)$. Indeed, for any $\tilde{u} = (a, u) \in \mathcal{M}_1^* \subset \mathcal{M}(\tilde{J}_1)$, Theorem 4.5.44 implies every $\tilde{v} = (b, v) \in \mathcal{M}(\tilde{J}_1)$ that is not an \mathbb{R} -translation of \tilde{u} and is sufficiently close to \tilde{u} in $\mathcal{M}(\tilde{J}_1)$ is also disjoint from it, in the sense that u and v don't intersect. But from (iii), we know that v does intersect w for some other curve

$\tilde{w} = (\beta, w) \in \mathcal{M}_1^*$, and if the images of v and w are not identical, we apply positivity of intersections and derive an intersection of v with u , hence a contradiction. This shows that \mathcal{M}_1^* is an open subset of $\mathcal{M}(\tilde{J}_1)$. It is also a closed subset, by a similar intersection argument. It's easy to see now that \mathcal{M}_1^* is connected in the topology of $\mathcal{M}(\tilde{J}_1)$; in fact,

$$\mathcal{M}_1^*/\mathbb{R} \cong S^1.$$

An explicit parametrization of this space can be derived by finding the unique intersection point of u with the Hopf circle P_0 for each $\tilde{u} = (a, u) \in \mathcal{M}_1^*$. Recall that P_0 is a periodic orbit, so one finds that \tilde{u} always has one positive intersection with the orbit cylinder $\mathbb{R} \times P_0$.

We know from Theorem 4.5.44 that neighboring curves in $\mathcal{M}_1^*/\mathbb{R}$ have distinct Morse-Bott limits at each puncture in Γ' . The limits of $\tilde{u} = (a, u) \in \mathcal{M}_1^*$ and $\tilde{v} = (b, v) \in \mathcal{M}_1^*$ at $z \in \Gamma'$ are therefore distinct unless $[\tilde{u}] = [\tilde{v}] \in \mathcal{M}_1^*/\mathbb{R}$; otherwise, v would have to intersect the close neighbors of u , contradicting (ii). \square

Corollary 5.1.20. *The moduli space \mathcal{M}_1^* constitutes a finite energy foliation of stable Morse-Bott type for $M = S^3 \setminus \text{int } N$, with respect to the data (λ_1, J_1) .*

In each of the solid tori N_j , we have coordinates (θ, ρ, ϕ) in which λ_1 takes the form $f(\rho)d\theta + g(\rho)d\phi$ and J_1 is adapted to the coordinates—thus the interior of N_j can be foliated by the explicit constructions of Sec. 3.1. This works even if N_j is changed by nontrivial Dehn surgeries. Supplementing these foliations with the orbit cylinders over the Morse-Bott orbits on $L_j = \partial N_j$, we've constructed a finite energy foliation of stable Morse-Bott type for the contact manifold obtained from (S^3, ξ_0) by Dehn surgeries and Lutz twists along K . This completes the proof of the main result, under the simplifying assumption that $\text{lk}(K_j, P_\infty) = 1$ for each component $K_j \subset K$.

This restriction will be removed in the next section.

5.1.5 The proof for general closed braids

The previous constructions cannot be assumed to work if K contains a knot K_j with $\text{lk}(K_j, P_\infty) \geq 2$. The trouble begins when we try to define the boundary condition for Problem (BP): the surface Σ must now have at least two distinct boundary components mapped to the same torus L_j , and it may not be possible to construct any family of pseudo-Lagrangian submanifolds covering L_j for which the original open book decomposition contains a solution. Even if we could do this, there would be problems preventing different boundary components from running into each other along L_j as the solution is deformed.

To avoid this complication, we shall use the previous arguments to construct a foliation on another contact manifold $(M^{(n)}, \lambda_1^{(n)})$ with boundary, which defines a branched cover of (M, λ_1) . An intersection argument will then show that the foliation has a well defined projection to a foliation on M . Here are the details.

First, assume $K \subset S^3$ is an arbitrary transverse link, and we have carried through the argument up to Corollary 5.1.8. Thus K is a closed braid near P_0 with $\text{lk}(K_j, P_\infty) \geq 1$ for each component $K_j \subset K$, and we have a planar open book decomposition \mathcal{F} for some tight contact form λ and complex multiplication J that have the usual simple form in neighborhoods $N_j \supset K_j$. In particular the Reeb orbits are tangent to ∂M , where M is S^3 with the solid tori N_j removed, as before.

Let $E = S^3 \setminus P_\infty$. Then the open book decomposition defines a fibration $E \rightarrow S^1$ with fibers E_τ for $\tau \in S^1$ corresponding to the pages of the foliation \mathcal{F} . For any $n \in \mathbb{N}$, there is another smooth fibration $E^{(n)} \rightarrow S^1$ defined naturally by setting

$$E_\tau^{(n)} = E_{n\tau}.$$

The total space $E^{(n)}$ is then a noncompact manifold diffeomorphic to $E = S^3 \setminus P_\infty$, and there is a natural smooth n -fold covering map

$$p : E^{(n)} \rightarrow E,$$

along with a cyclic group of deck transformations $\psi^k : E^{(n)} \rightarrow E^{(n)}$ for $k \in \mathbb{Z}_n$, generated by the map ψ that defines the natural diffeomorphism

$$E_\tau^{(n)} \xrightarrow{\psi} E_{\tau + \frac{1}{n}}^{(n)}$$

for each $\tau \in S^1$.

All of the data we have on $E = S^3 \setminus P_\infty$ now lifts to the covering $E^{(n)}$. In particular, define a contact form $\lambda^{(n)} = p^*\lambda$ on $E^{(n)}$, along with an admissible complex multiplication $J^{(n)} = p^*J : \xi^{(n)} \rightarrow \xi^{(n)}$. These define an almost complex structure $\tilde{J}^{(n)}$ on $\mathbb{R} \times E^{(n)}$, and each leaf of the foliation \mathcal{F} also lifts to n distinct $\tilde{J}^{(n)}$ -holomorphic embeddings $\mathbb{C} \rightarrow \mathbb{R} \times E^{(n)}$. The deck transformation ψ satisfies $\psi^*\lambda^{(n)} = \lambda^{(n)}$ and $\psi^*J^{(n)} = J^{(n)}$, thus it defines a $\tilde{J}^{(n)}$ -holomorphic diffeomorphism

$$\tilde{\psi} : \mathbb{R} \times E^{(n)} \rightarrow \mathbb{R} \times E^{(n)} : (a, x) \mapsto (a, \psi(x)).$$

There is also a transverse link $K^{(n)} = p^{-1}(K) \subset E^{(n)}$ such that $\psi(K^{(n)}) = K^{(n)}$, as well as a tubular neighborhood $K^{(n)} \subset N^{(n)} \subset E^{(n)}$ with $\psi(N^{(n)}) = N^{(n)}$. Notice that K and $K^{(n)}$ each define closed braids with the same number of strings, but $K^{(n)}$ need not have the same number of components as K , and the deck transformations may permute components. The point of all this is that if n is chosen to be the least

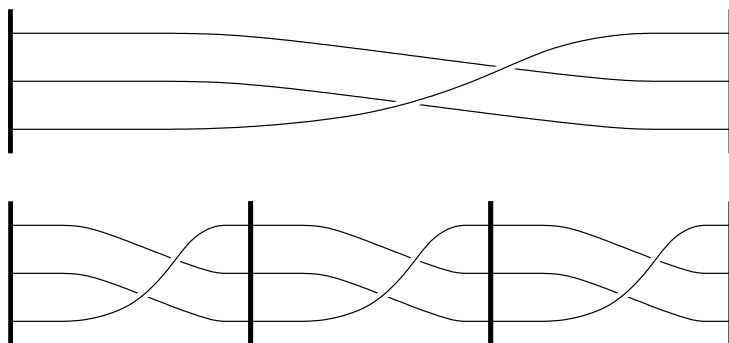

Figure 5.3: The top is a transverse knot K with $\text{lk}(K, P_\infty) = 3$, represented as a closed braid. The bottom is the 3-fold cover $K^{(3)} \subset E^{(3)}$, with three components cyclically permuted by ψ .

common multiple of all the linking numbers $\text{lk}(K_j, P_\infty)$, then $K^{(n)}$ has precisely as many components as the number of strings in the braid, i.e. each component wraps around only once (Figure 5.3). Thus our surgery techniques can be applied to derive a foliation of $E^{(n)} \setminus N^{(n)}$. However, before doing this we need to make $(E^{(n)}, \lambda^{(n)})$ compact, which requires closer examination of the covering map in a neighborhood of the binding orbit P_∞ .

For this purpose we need to assume there are coordinates (θ, ρ, ϕ) on E near P_∞ in which $P_\infty = \{\rho = 0\}$, J is adapted to the coordinates and $\lambda = f(\rho)d\theta + g(\rho)d\phi$ for some functions f and g that satisfy $f'g'' - f''g' \equiv 0$ near 0. This is easy to arrange, for instance, by choosing the initial open book decomposition to be the stabilized foliation from Example 3.2.1. It is *almost* true for the irrational ellipsoid as well: λ_E takes the right form in the coordinates from Example 3.2.1, though J_E might not be adapted, but this could presumably be fixed by a deformation argument similar to Sec. 5.1.2. In any case, we assume J is defined by a condition of the form

$$Jv_1 = \beta(\rho)v_2$$

as in Chapter 3, where $v_1 = \partial_\rho$, $d\rho(v_2) = 0$ and $d\lambda(v_1, v_2) \equiv 1$. One can deduce from these facts that if J is smooth at P_∞ , we must have $\lim_{\rho \rightarrow 0} \beta(\rho) = g''(0) > 0$.

The assumption $f'g'' - f''g' \equiv 0$ means that the trajectory $\rho \mapsto (f(\rho), g(\rho))$ through \mathbb{R}^2 follows a straight line. This, and the condition on J are unaffected if we make a coordinate change of the form

$$(\theta, \rho, \phi) \longleftrightarrow (\theta, \rho, \phi + 2\pi k\theta)$$

for some $k \in \mathbb{Z}$. We may therefore assume without loss of generality that the planes of the open book decomposition do not wind around P_∞ as they approach—this

implies also that the circles $\{(\rho, \phi) = \text{const}\}$ for $\rho > 0$ are unlinked with P_∞ . We can now deduce something about the slope of the trajectory $(f(\rho), g(\rho))$ from the fact that $\mu_{\text{CZ}}(P_\infty) = 3$. Indeed, let $v_0(\theta) = \partial_x \in \xi_{(\theta, 0, 0)}$ be the nonzero section of ξ along P_∞ determined by the coordinates, and let v be a global nonzero section of ξ . Some general knowledge of the tight three-sphere then implies $\text{wind}_{P_\infty}^{v_0}(v) = -1$, and from Prop. 3.1.2, we have

$$3 = \mu_{\text{CZ}}(P_\infty) = \mu_{\text{CZ}}^{v_0}(P_\infty) + 2 \text{wind}_{P_\infty}^v(v_0) = 2 \left[-\frac{f''(0)}{2\pi g''(0)} \right] + 3,$$

hence $f''(0)/2\pi g''(0) \in (-1, 0)$.

With this preparation, we choose similar coordinates (θ, ρ, ϕ) on a neighborhood of the missing unknot in $E^{(n)}$, and define the covering map in this neighborhood explicitly by

$$p(\theta, \rho, \phi) = (\theta, \rho, n\phi).$$

Since the framing along P_∞ determined by the open book decomposition is the same as that of the coordinate system, this map extends to the rest of $E^{(n)}$ in a manner determined by the pages of the open book. Let $\overline{E}^{(n)}$ be the compactification of $E^{(n)}$ obtained by filling in the circle $P_\infty^{(n)} := \{\rho = 0\}$. Then p extends as a branched covering map

$$p : \overline{E}^{(n)} \rightarrow S^3,$$

which is nonsmooth but continuous at $P_\infty^{(n)}$; the latter is mapped homeomorphically to P_∞ . In coordinates on $E^{(n)}$, the contact form is now

$$\lambda^{(n)} = f(\rho)d\theta + ng(\rho)d\phi =: f_n(\rho)d\theta + g_n(\rho)d\phi,$$

which extends smoothly to $\overline{E}^{(n)}$. Moreover, $P_\infty^{(n)}$ is then a nondegenerate periodic orbit, with

$$\mu_{\text{CZ}}(P_\infty^{(n)}) = 2 \left[-\frac{f_n''(0)}{2\pi g_n''(0)} \right] + 3 = 2 \left[-\frac{1}{n} \frac{f''(0)}{2\pi g''(0)} \right] + 3 = 3.$$

A complication arises with the complex structure $J^{(n)} = p^*J$: defining the usual symplectic trivialization $\{v_1^{(n)}, v_2^{(n)}\}$ of $\xi^{(n)}$, a calculation shows that

$$J^{(n)}v_1^{(n)} = \beta_n(\rho)v_2^{(n)}$$

where $\beta_n(\rho) = \beta(\rho)$. This looks great but is actually terrible, because we know that $J^{(n)}$ can only be smooth at $P_\infty^{(n)}$ if $g_n''(0) = \lim_{\rho \rightarrow 0} \beta_n(\rho)$, which is not true since the same thing equals $g''(0) = g_n''(0)/n$.

We will therefore need to change β_n before proceeding. By the discussion in Sec. 3.2, this can be done without sacrificing the given family of holomorphic curves asymptotic to P_∞ . Indeed, these maps lift to $\tilde{J}^{(n)}$ -holomorphic embeddings

$$\tilde{v} = (b, v) : \mathbb{C} \rightarrow \mathbb{R} \times \overline{E}^{(n)}$$

which are contained in $\mathbb{R} \times E^{(n)}$ and approach $P_\infty^{(n)}$ asymptotically. Changing $\beta_n(\rho)$ in a neighborhood of 0 so that $J^{(n)}$ becomes smooth at $P_\infty^{(n)}$, the condition $f'_n g''_n - f''_n g'_n \equiv 0$ implies that we can find new solutions \tilde{w} that match \tilde{v} outside a neighborhood of $P_\infty^{(n)}$. These form a stable open book decomposition of $(\overline{E}^n, \lambda^{(n)}, J^{(n)})$ by finite energy planes.

We now repeat the arguments of the previous sections to define a finite energy foliation of stable Morse-Bott type on $M^{(n)} := \overline{E}^n \setminus \text{int } N^{(n)}$, with the contact form twisted to $\lambda_1^{(n)}$, which has horizontal Morse-Bott orbits on $\partial M^{(n)}$. All changes to $\lambda^{(n)}$ and $J^{(n)}$ can be made in an equivariant way, e.g. we can define the homotopies $\lambda_r^{(n)}$ and $J_r^{(n)}$ by pulling back similar homotopies λ_r and J_r on M via the covering projection. This guarantees that there is always a \mathbb{Z}_n -family of deck transformations $\psi^k : M^{(n)} \rightarrow M^{(n)}$ which preserve both the contact form and the complex structure. In particular, \mathbb{Z}_n acts on $(M^{(n)}, \lambda_1^{(n)}, J_1^{(n)})$, and therefore on the almost complex manifold $(\mathbb{R} \times M^{(n)}, \tilde{J}_1^{(n)})$ via holomorphic diffeomorphisms $\tilde{\psi}^k$. In addition to the finite energy foliation \mathcal{F} for $(M^{(n)}, \lambda_1^{(n)}, J_1^{(n)})$, we therefore obtain n such foliations $\mathcal{F}_k := \tilde{\psi}^k(\mathcal{F})$ for $k \in \mathbb{Z}_n$.

Proposition 5.1.21. *The foliations \mathcal{F}_k for $k \in \mathbb{Z}_n$ are all identical.*

Proof. It suffices to show that for any leaf $\tilde{u} = (a, u) \in \mathcal{F}$, the curve

$$\tilde{\psi} \circ \tilde{u} = (a, \psi \circ u) : \dot{\Sigma} \rightarrow \mathbb{R} \times M^{(n)}$$

is also a leaf of the foliation. This follows from the intersection theory of finite energy surfaces. Indeed, if $\tilde{\psi} \circ \tilde{u}$ is not a leaf, it must have finitely many isolated intersections with some other leaf $\tilde{v} = (b, v) \in \mathcal{F}$, and by positivity of intersections, these cannot be eliminated under homotopies. Thus $\tilde{\psi} \circ \tilde{u}$ also has isolated intersections with \tilde{u} . Such intersections also cannot be eliminated under arbitrarily large \mathbb{R} -translations, so $\tilde{\psi} \circ \tilde{u}$ intersects $\tilde{u}^\sigma = (a + \sigma, u)$ for all $\sigma \in \mathbb{R}$. Since $a : \dot{\Sigma} \rightarrow \mathbb{R}$ is a proper map, choosing σ large forces these intersections toward the asymptotic limits. But \tilde{u} and $\tilde{\psi} \circ \tilde{u}$ clearly have distinct asymptotic limits, and neither curve intersects the asymptotic limits of the other, thus we have a contradiction. \square

The situation is now as follows. There is an n -fold covering map $p : M^{(n)} \setminus P_\infty^{(n)} \rightarrow M \setminus P_\infty$ and a stable Morse-Bott finite energy foliation \mathcal{F} on $M^{(n)}$ which

is invariant under the deck transformations $\psi^k : M^{(n)} \rightarrow M^{(n)}$. Redefining the complex multiplication over $M \setminus P_\infty$ by $J_1 = p_* J_1^{(n)}$ and defining the corresponding almost complex structure \tilde{J}_1 on $\mathbb{R} \times (M \setminus P_\infty)$, the foliation \mathcal{F} now projects to a \tilde{J}_1 -holomorphic foliation of $\mathbb{R} \times (M \setminus P_\infty)$, each leaf having a positive puncture asymptotic to P_∞ . To make this an honest finite energy foliation, we must once again change J_1 to a smooth complex multiplication near P_∞ , and the foliation survives this change by the same argument as before.

The proof of Theorem 1.3.2 is now complete.

Of course, we postponed the hard part: the compactness proofs will be dealt with in the next two sections.

5.2 Compactness by linking arguments

In this section we present a compactness result which implies Theorems 5.1.7, 5.1.12 and 5.1.15. The recurring theme is that any bubbling that arises will present a contradiction to some known fact about linking numbers of knots in S^3 . To illustrate the idea, let us start by sketching a proof of the simplest version, Theorem 5.1.7. Recall that in that case, we have a compact sequence of almost complex structures \tilde{J}_k defined by contact forms λ_k on S^3 whose Reeb vector fields have the property that all periodic orbits other than P_∞ are nontrivially linked with P_∞ . Then given a sequence of embedded \tilde{J}_k -holomorphic finite energy planes $\tilde{u}_k = (a_k, u_k) : \mathbb{C} \rightarrow \mathbb{R} \times S^3$, all asymptotic to P_∞ , we argue that there must be a uniform gradient bound, and thus by standard results in elliptic theory, \tilde{u}_k has a convergent subsequence. The gradient bound is obtained by a bubbling-off argument: if there is no such bound, one can reparametrize \tilde{u}_k on a shrinking sequence of disks so that the reparametrized maps have a subsequence convergent to another finite energy plane $\tilde{v} = (b, v) : \mathbb{C} \rightarrow \mathbb{R} \times S^3$. For energy reasons, \tilde{v} must be asymptotic to a periodic orbit $P \subset S^3$ with *smaller period* than that of P_∞ ; thus P is a different orbit, and must therefore be nontrivially linked with P_∞ . Topologically, $v : \mathbb{C} \rightarrow S^3$ defines a disk spanning P , which must therefore intersect P_∞ . But this presents a contradiction, for it would allow us to prove that u_k intersects its asymptotic limit for sufficiently large k , and this is known to be false in our situation.

This simple argument is an important ingredient for proving the more general result for holomorphic planes with boundary. An additional complication arises in the latter case because the domain may have varying nonequivalent conformal structures. This widens the range of bubbling phenomena that we'll have to consider, but we will still be able to exclude such possibilities by linking arguments. Figure 5.4 attempts a pictorial rendering of the contradiction described above, and one other non-bubbling argument which will be useful in what follows.

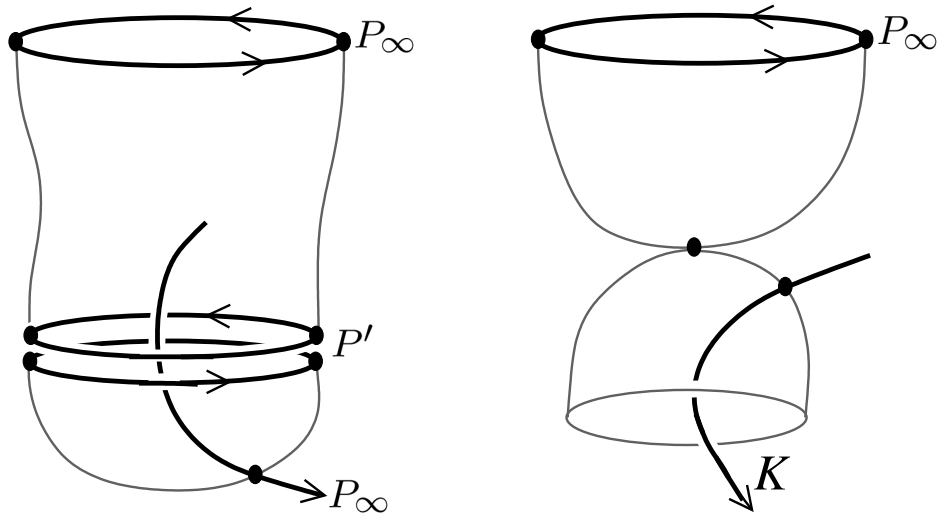

Figure 5.4: Some topological obstructions to noncompactness. Left: a finite energy plane bubbles off and produces an illegal intersection with the asymptotic limit P_∞ . Right: the appearance of a node produces an illegal intersection with the transverse knot K .

We begin by summarizing the properties of our setup that are crucial for the compactness proof. For any pair of oriented knots γ and $\gamma' \subset S^3$, denote their linking number by $\text{lk}(\gamma, \gamma')$. We are given an oriented knot $P_\infty \subset S^3$ and an oriented link $K = K_1 \cup \dots \cup K_m \subset S^3 \setminus P_\infty$ whose components satisfy $\text{lk}(P_\infty, K_j) > 0$.² Each knot K_j is the center of a solid torus N_j ; we assume that these solid tori are pairwise disjoint and that $N := N_1 \cup \dots \cup N_m \subset S^3$ is disjoint from P_∞ . Denote $\partial N_j = L_j$ and $M = S^3 \setminus (\text{int } N)$, so the oriented boundary of M is $\partial M = -\bigcup_j L_j$. Let λ_k be a sequence of contact forms on S^3 which are C^∞ -convergent to a contact form λ_∞ and satisfy the following properties for all $k \leq \infty$:

1. P_∞ is a nondegenerate periodic orbit of X_{λ_k} .
2. Any other periodic orbit $P \subset M \setminus P_\infty$ of X_{λ_k} satisfies $\text{lk}(P, P_\infty) \neq 0$.
3. X_{λ_k} is tangent to each torus L_j
4. There are trivializations Φ_k of $\xi_k|_M$ (where $\xi_k = \ker \lambda_k$) such that $\mu_{\text{CZ}}^{\Phi_k}(P_\infty) = 3$ and, if $\gamma \subset L_j$ is a positively oriented meridian, $\text{wind}_\gamma^{\Phi_k}(TL_j \cap \xi_k) = 1$.

²None of the compactness discussion here depends on the simplifying assumption made in Sec. 5.1.3 that $\text{lk}(K_j, P_\infty) = 1$; except perhaps implicitly, in that we assume there are uniform energy bounds.

In our specific setup, the trivializations Φ_k are derived from a global trivialization of the standard contact structure ξ_0 , using the fact that ξ_k and ξ_0 are homotopic distributions on M (*not* on all of S^3).

The almost complex structures \tilde{J}_k on $\mathbb{R} \times S^3$ are defined in terms of λ_k and a compact sequence of admissible complex multiplications $J_k : \xi_k \rightarrow \xi_k$. We can assume by taking a subsequence that there is a complex structure J_∞ such that $J_k \rightarrow J_\infty$ in the C^∞ -topology, and thus $\tilde{J}_k \rightarrow \tilde{J}_\infty$.

We will consider sequences of \tilde{J}_k -holomorphic curves $\tilde{u}_k = \dot{\Sigma} \rightarrow \mathbb{R} \times S^3$, where $\partial\Sigma$ has m connected components $\gamma_1, \dots, \gamma_m$, and solutions satisfy a boundary condition of the form $\tilde{u}_k(\gamma_j) \subset \tilde{L}_j^\sigma$. The totally real tori $\tilde{L}_j^\sigma \subset \mathbb{R} \times S^3$ are graphs of smooth families of functions $\{G_j^\sigma : L_j \rightarrow \mathbb{R}\}_{\sigma \in \mathbb{R}}$. We assume these families are *asymptotically \mathbb{R} -invariant* in the sense that $\frac{\partial}{\partial \sigma} G_j^\sigma$ is constant for sufficiently large $|\sigma|$, and also that each torus \tilde{L}_j^σ is *pseudo-Lagrangian* with respect to λ_k for all k . These assumptions cover two qualitatively different situations that arise in the construction of foliations: in one case the contact forms λ_k are all identical while the families \tilde{L}_j^σ are not \mathbb{R} -invariant but pseudo-Lagrangian and asymptotically flat—in the other case we use a sequence of distinct contact forms with fixed \mathbb{R} -invariant families of Lagrangian submanifolds. Either way, there is a taming set \mathcal{T} which gives uniform energy bounds for the solutions of interest (see Props. 4.6.15 and 5.1.16).

Remark 5.2.1. *The discussion so far assumes \tilde{L}_j^σ and \tilde{L}_i^σ are disjoint if $j \neq i$, but one could just as well allow them to be identical, so that different components of $\partial\Sigma$ satisfy the same boundary condition. This is necessary if one of the knots K_j has $\text{lk}(K_j, P_\infty) \geq 2$.*

Theorem 5.2.2. *Given the data on S^3 described above, let $\Sigma = S^2 \setminus (\mathcal{D}_1 \cup \dots \cup \mathcal{D}_m)$ be the sphere $\mathbb{C} \cup \{\infty\}$ with a finite collection of open disks $\mathcal{D}_j \subset \mathbb{C}$ removed, and denote $\dot{\Sigma} = \Sigma \setminus \{\infty\}$. Let $\tilde{u}_k = (a_k, u_k) : \dot{\Sigma} \rightarrow \mathbb{R} \times S^3$ be a sequence of \tilde{J}_k -holomorphic solutions to Problem (BP), each positively asymptotic to P_∞ at ∞ , and with the following additional properties:*

- (i) $u_k(\dot{\Sigma}) \subset M \setminus P_\infty$ for all k .
- (ii) For each component $\gamma_j \subset \partial\Sigma$ and for all k , the oriented loop $u_k(\gamma_j)$ is homotopic along L_j to a negatively oriented meridian, i.e. $\text{lk}(u_k(\gamma_j), P_\infty) = 0$ and $\text{lk}(u_k(\gamma_j), K_j) = -1$.
- (iii) There is a taming set \mathcal{T} for which the energies

$$E_k(\tilde{u}_k) = \sup_{\varphi \in \mathcal{T}} \int_{\dot{\Sigma}} \tilde{u}^* d(\varphi \lambda_k)$$

are uniformly bounded.

Then there is a sequence of numbers $c_k \in \mathbb{R}$ and diffeomorphisms $\varphi_k : \Sigma \rightarrow \Sigma$ that fix ∞ and preserve each component of $\partial\Sigma$, such that the translations $(a_k + c_k, u_k)$ are solutions of **(BP)**, and a subsequence of $(a_k + c_k, u_k) \circ \varphi_k$ converges in C_{loc}^∞ to a \tilde{J}_∞ -holomorphic solution \tilde{u}_∞ of **(BP)** with positive asymptotic limit P_∞ .

Theorems 5.1.12 and 5.1.15 follow from this immediately. Theorem 5.1.7 follows as a special case by assuming $K = \emptyset$ and $m = 0$.

One can gain intuition as to why Theorem 5.2.2 should be true by imagining how the main compactness theorem from [BEHWZ03] might be adapted for Problem **(BP)**. We expect that *a priori*, $\tilde{u}_k = (a_k, u_k)$ should converge to some kind of holomorphic building with boundary, with multiple levels connected by periodic orbits as well as separate components connected by nodes in the interior and at the boundary (Figure 5.5). Then there is a continuous map $u_\infty : \dot{\Sigma} \rightarrow M$ such that $u_k \rightarrow u_\infty$ in the C^0 -topology, and we could extend these all to continuous maps $\mathbb{C} \rightarrow S^3$ by sending the disks \mathcal{D}_j into N_j , using the fact that u_k maps each boundary component to a meridian. In principle then, this reduces to the case $\dot{\Sigma} = \mathbb{C}$, where as we outlined above, bubbling off can be ruled out by a fairly simple linking argument.

In practice, proving a general Gromov-type compactness theorem would be rather difficult because we're not making any serious assumptions about the nondegeneracy of λ_∞ . This means the set of periods of X_{λ_∞} might not be discreet, so we cannot bound the energies above zero. Fortunately this is unnecessary; the actual compactness of \tilde{u}_k can be established more directly by topological arguments. We'll work through this in the next few subsections.

5.2.1 Gradient bounds

The first step in proving Theorem 5.2.2 is to find uniform gradient bounds for the sequence $\tilde{u}_k : \dot{\Sigma} \rightarrow \mathbb{R} \times S^3$. Note first that the complex structures $j_k = \tilde{u}_k^* \tilde{J}_k$ extend over the puncture $\infty \in \Sigma$ to give smooth complex structures on Σ . We shall deal first with the case in which $(\Sigma, j_k, \{\infty\})$ is a sequence of stable Riemann surfaces in the sense of Appendix B, i.e. $\chi(\Sigma) < 0$. After establishing uniform gradient bounds in the stable case, it will be easy to apply the same methods and complete the compactness proof in the non-stable cases. The next section will then deal with the possibility that j_k might degenerate, which is only relevant if $\partial\Sigma$ has at least two boundary components.

For most of this section, we therefore assume $\chi(\dot{\Sigma}) < 0$. Recall that each stable Riemann surface $(\Sigma, j_k, \{\infty\})$ defines a natural hyperbolic metric h_k on $\dot{\Sigma} = \Sigma \setminus \{\infty\}$, for which each component of $\partial\Sigma$ is a geodesic (see Appendix B). This metric is the restriction of the Poincaré metric h_k^D defined on the doubled surface $(\dot{\Sigma}^D, j_k^D)$. Denote the injectivity radius of h_k^D at any point $z \in \dot{\Sigma} \subset \dot{\Sigma}^D$ by $\text{inrad}_{h_k}(z)$.

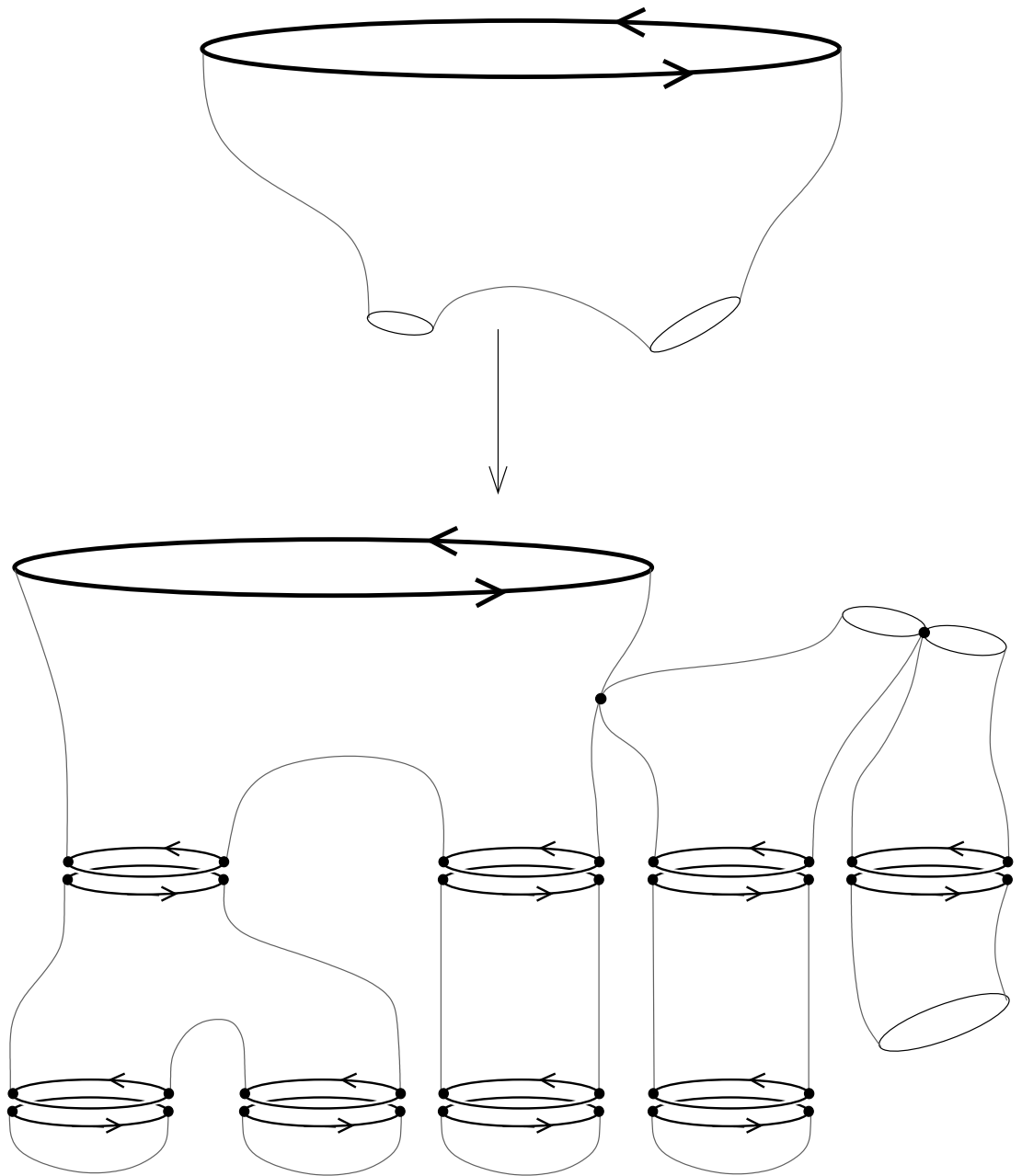

Figure 5.5: Finite energy planes with two boundary components converging to a three-level holomorphic building with boundary.

Fix any metric g on S^3 and extend it in the natural way to an \mathbb{R} -invariant metric \tilde{g} on $\mathbb{R} \times S^3$. In the following, we will always use the Euclidean metric on subsets Ω of \mathbb{C} or $\mathbb{R} \times S^1$, and one of the Poincaré metrics h_k on $\dot{\Sigma}$. Then our notation for norms of first derivatives is defined as follows:

$$\begin{aligned} \tilde{u} : \dot{\Sigma} &\rightarrow \mathbb{R} \times M &\Rightarrow & |d\tilde{u}(z)|_k := \sup_{Y \in T_z \dot{\Sigma} \setminus \{0\}} \frac{|d\tilde{u}(z)Y|_{\tilde{g}}}{|Y|_{h_k}} \\ \varphi : \Omega &\rightarrow \dot{\Sigma} &\Rightarrow & |d\varphi(z)|_k := \sup_{Y \in \mathbb{C} \setminus \{0\}} \frac{|d\varphi(z)Y|_{h_k}}{|Y|} \\ \tilde{v} : \Omega &\rightarrow \mathbb{R} \times M &\Rightarrow & |\nabla \tilde{v}(z)| := \sup_{Y \in \mathbb{C} \setminus \{0\}} \frac{|d\tilde{v}(z)Y|_{\tilde{g}}}{|Y|} \end{aligned}$$

The main objective of this section is a bound on $|d\tilde{u}_k|_k$:

Proposition 5.2.3. *If $\chi(\dot{\Sigma}) < 0$, then there is a constant $C > 0$ such that*

$$|d\tilde{u}_k(z)|_k \leq \frac{C}{\text{injr}_{h_k}(z)} \quad (5.2.1)$$

for all $z \in \dot{\Sigma}$ and all k .

The bound will follow from a bubbling off argument carried out in conformal coordinates, but before delving into the details, we must first prove that such coordinates can always be chosen with careful control over the first derivatives. To set this up, assume (Σ, j, Γ) is a stable Riemann surface without boundary. We assign to $\dot{\Sigma} = \Sigma \setminus \Gamma$ the Poincaré metric h , and denote by $\text{injr}_h(z)$ the injectivity radius of h at the point $z \in \dot{\Sigma}$. Observe that for a given topological type of $\dot{\Sigma}$, there is a universal upper bound for $\text{injr}_h(z)$, independent of j and z ; this follows from the Deligne-Mumford compactness theorem and the fact that $\text{injr}_h(z)$ approaches zero at each puncture.

It will be useful to recall the universal cover of $(\dot{\Sigma}, j)$. If η is the Euclidean metric on \mathbb{D} , we define the hyperbolic metric \tilde{h} on the open unit disk $\mathcal{D} \subset \mathbb{D}$ by

$$\tilde{h}_z = \frac{4}{(1 - |z|^2)^2} \eta_z.$$

Then there is a holomorphic covering projection $p : \mathcal{D} \rightarrow \dot{\Sigma}$ such that $p^*h = \tilde{h}$. Any two points in \mathcal{D} are connected by a unique geodesic of \tilde{h} , which is a circular arc or line segment that meets $\partial\mathbb{D}$ orthogonally at times $\pm\infty$. Thus the distance

from 0 to any point $z \in \mathcal{D}$ is an integral over the line segment connecting them; we characterize this by a function

$$f(|z|) := \text{dist}_{\tilde{h}}(0, z) = \int_0^{|z|} \frac{2 dt}{1-t^2} = \ln \left(\frac{1+|z|}{1-|z|} \right). \quad (5.2.2)$$

This is an increasing diffeomorphism $f : [0, 1) \rightarrow [0, \infty)$, and its derivative is also an increasing function. The group of deck transformations is a subgroup $G \subset \text{Aut}(\mathcal{D})$ acting freely on \mathcal{D} , and we have $\dot{\Sigma} \cong \mathcal{D}/G$. Recall also the standard fact that for any $z \in \mathcal{D}$,

$$\text{injr}_{\tilde{h}}(p(z)) = \frac{1}{2} \inf_{\psi \in G \setminus \{\text{Id}\}} \text{dist}_{\tilde{h}}(z, \psi(z)).$$

See [Hm97] for a proof.

In the following, we shall always use h as the metric on $\dot{\Sigma}$, while using the Euclidean metric on the closed disk \mathbb{D} (not to be confused with the hyperbolic *open* disk (\mathcal{D}, \tilde{h})).

Lemma 5.2.4. *Let $(\dot{\Sigma}, j)$ be a punctured Riemann surface without boundary. There are positive constants c_i and C_i depending only on the topological type of $\dot{\Sigma}$ (i.e. not on j), such that the following is true: for any $z_0 \in \dot{\Sigma}$ and any geodesic γ passing through z_0 , there is a holomorphic embedding $\varphi : \mathbb{D} \hookrightarrow \dot{\Sigma}$ such that $\varphi(0) = z_0$, φ maps $\mathbb{R} \cap \mathbb{D}$ to γ preserving orientation, and*

$$c_1 \cdot \text{injr}_{\tilde{h}}(z_0) \leq |d\varphi(z)|_h \leq C_1 \cdot \text{injr}_{\tilde{h}}(z_0) \quad \text{for all } z \in \mathbb{D}. \quad (5.2.3)$$

For any $\rho \in [0, 1]$, the image $\varphi(\mathbb{D}_\rho)$ is then a closed ball of radius $d(\rho)$ in $(\dot{\Sigma}, h)$, where

$$c_2 \rho \cdot \text{injr}_{\tilde{h}}(z_0) \leq d(\rho) \leq C_2 \rho \cdot \text{injr}_{\tilde{h}}(z_0), \quad (5.2.4)$$

and the injectivity radius at any point $\varphi(w)$ for $w \in \mathbb{D}$ with $|w| = \rho$ can be estimated by

$$(c_3 - c_4 \rho) \cdot \text{injr}_{\tilde{h}}(z_0) \leq \text{injr}_h(\varphi(w)) \leq (1 + C_3 \rho) \cdot \text{injr}_{\tilde{h}}(z_0) \quad (5.2.5)$$

Proof. The embeddings can be constructed more or less explicitly in terms of the cover $p : (\mathcal{D}, \tilde{h}) \rightarrow (\dot{\Sigma}, h)$. Given $z_0 \in \dot{\Sigma}$ and the geodesic γ , we can compose p with an automorphism of \mathcal{D} in order to assume, without loss of generality, that $p(0) = z_0$ and $p(\mathbb{R} \cap \mathcal{D}) = \gamma$, the latter preserving the direction of γ .

Now for some $r \in (0, 1)$ define a holomorphic immersion by $\varphi : \mathbb{D} \rightarrow \dot{\Sigma}$ by $\varphi(z) = p(rz)$. We claim that this is an embedding if $f(r) < \text{injr}_{\tilde{h}}(z_0)$, where f is the function defined in (5.2.2). Otherwise, denoting by \mathbb{D}_r the disk of radius r , there

is a deck transformation $\psi \in G$ such that \mathbb{D}_r and $\psi(\mathbb{D}_r)$ intersect. Assuming this, pick z and z' in \mathbb{D}_r such that $\psi(z') = z$. Then using the fact that ψ is an isometry of \tilde{h} ,

$$\begin{aligned} \text{dist}_{\tilde{h}}(0, \psi(0)) &\leq \text{dist}_{\tilde{h}}(0, z) + \text{dist}_{\tilde{h}}(z, \psi(0)) \\ &= \text{dist}_{\tilde{h}}(0, z) + \text{dist}_{\tilde{h}}(\psi(z'), \psi(0)) \\ &= \text{dist}_{\tilde{h}}(0, z) + \text{dist}_{\tilde{h}}(0, z') \\ &\leq 2 \text{dist}_{\tilde{h}}(0, r) = 2f(r) < 2 \text{injrads}_h(z_0) \leq \text{dist}_{\tilde{h}}(0, \psi(0)), \end{aligned}$$

yielding a contradiction. We can therefore assume φ is an embedding if we set $r := \frac{1}{2}f^{-1}(\text{injrads}_h(z_0))$. This number is related to the derivative of φ as follows. At any $z \in \mathbb{D}$, using the fact that p is an isometric immersion $(\mathcal{D}, \tilde{h}) \rightarrow (\dot{\Sigma}, h)$, we have

$$\begin{aligned} |d\varphi(z)|_h^2 &= \sup_{|v|=1} |h_{\varphi(z)}(dp(rz) \cdot rv, dp(rz) \cdot rv)| = r^2 \sup_{|v|=1} |\tilde{h}_{rz}(v, v)| \\ &= r^2 \sup_{|v|=1} \frac{4}{(1 - |rz|^2)^2} |v|^2 = \frac{4r^2}{(1 - r^2|z|^2)^2}, \end{aligned}$$

so $|d\varphi(z)|_h$ is uniformly bounded between $2r$ and $2r/(1 - r^2)$. The lower bound is precisely $f^{-1}(\text{injrads}_h(z_0))$, and the upper bound is itself bounded by $\frac{4}{3} \cdot 2r = \frac{4}{3}f^{-1}(\text{injrads}_h(z_0))$ since, by our definition, r never exceeds $1/2$. Noting that $f'(0) > 0$ and f' is increasing, we can easily choose a constant $C > 0$ such that $Cx \geq \frac{4}{3}f^{-1}(x)$ for all x . Similarly we can choose c such that $cx \leq f^{-1}(x)$ for all $x \in [0, M]$, where $M = \sup_{z,j} \text{injrads}_h(z)$. Thus we have

$$\begin{aligned} c \cdot \text{injrads}_h(z_0) &\leq f^{-1}(\text{injrads}_h(z_0)) = 2r \\ &\leq |d\varphi(z)|_h \leq \frac{2r}{1 - r^2} \leq \frac{4}{3} \text{injrads}_h(z_0) \leq C \cdot \text{injrads}_h(z_0). \end{aligned}$$

It is clear from this construction that for any $\rho \in [0, 1]$, $\varphi(\mathbb{D}_\rho)$ is a closed ball of radius $d(\rho) := f(\rho r)$ in $(\dot{\Sigma}, h)$. There are constants c and C such that $cx \leq f(x) \leq Cx$ for all $x \in [0, f^{-1}(M)]$, thus

$$\begin{aligned} \frac{c}{2C}\rho \cdot \text{injrads}_h(z_0) &= \frac{c}{2C}\rho f(2r) \leq c\rho r \\ &\leq f(\rho r) = d(\rho) \\ &\leq C\rho r = \frac{C}{2c}\rho c \cdot 2r \leq \frac{C}{2c}\rho f(2r) = \frac{C}{2c}\rho \cdot \text{injrads}_h(z_0). \end{aligned}$$

Finally, let $w \in \mathbb{D}$ with $|w| = \rho \in [0, 1]$. To bound $\text{injrads}_h(\varphi(w))$ from above, note first that for any $\epsilon > 0$, there is a point $z_2 \in p^{-1}(z_0) \subset \mathcal{D}$ such that $\text{dist}_{\tilde{h}}(0, z_2) <$

$2 \operatorname{inrad}_h(z_0) + \epsilon$. Then let $w_1 = rw \in \mathcal{D}$ and choose another $w_2 \in \mathcal{D}$ such that $p(w_2) = p(w_1) = \varphi(w)$ and $\operatorname{dist}_{\tilde{h}}(z_2, w_2) = \operatorname{dist}_{\tilde{h}}(0, w_1) = f(r\rho)$. We have

$$\begin{aligned} \operatorname{inrad}_h(\varphi(w)) &\leq \frac{1}{2} \operatorname{dist}_{\tilde{h}}(w_1, w_2) \\ &\leq \frac{1}{2} (\operatorname{dist}_{\tilde{h}}(w_1, 0) + \operatorname{dist}_{\tilde{h}}(0, z_2) + \operatorname{dist}_{\tilde{h}}(z_2, w_2)) \\ &= \operatorname{inrad}_h(z_0) + f(r\rho) + \epsilon \leq \left(1 + \frac{C}{2c}\rho\right) \operatorname{inrad}_h(z_0) + \epsilon. \end{aligned}$$

A bound from below is obtained by observing that the ball of radius $\operatorname{dist}_{\tilde{h}}(0, r) - \operatorname{dist}_{\tilde{h}}(0, w_1) = f(r) - f(\rho r)$ about $w_1 \in \mathcal{D}$ is contained in $\mathbb{D}_r \subset \mathcal{D}$, so the projection down to $\dot{\Sigma}$ is injective on this ball. Consequently, any other point $w_2 \in \mathcal{D}$ with $p(w_2) = p(w_1) = \varphi(w)$ is at least this far away from w_1 , and

$$\begin{aligned} \operatorname{inrad}_h(\varphi(w)) &\geq \frac{1}{2}(f(r) - f(\rho r)) \geq \frac{1}{2}(cr - C\rho r) = \frac{c - C\rho}{4C} C \cdot 2r \\ &\geq \left(\frac{c}{4C} - \frac{1}{4}\rho\right) f(2r) = \left(\frac{c}{4C} - \frac{1}{4}\rho\right) \cdot \operatorname{inrad}_h(z_0). \end{aligned}$$

□

Remark 5.2.5. *Lemma 5.2.4 extends to surfaces $\dot{\Sigma}$ with nonempty boundary as follows: for any $z_0 \in \partial\Sigma$, the component $\gamma \subset \partial\Sigma$ containing z_0 is a closed geodesic in the doubled surface $(\dot{\Sigma}^D, h^D)$. Thus the lemma gives an embedding $\varphi : \mathbb{D}^+ \rightarrow \dot{\Sigma}$ that sends 0 to z_0 and $\mathbb{R} \cap \mathbb{D}^+$ into $\partial\Sigma$.*

Proof of Prop. 5.2.3. Assume there exists a sequence $z_k \in \dot{\Sigma}$ such that $\operatorname{inrad}_{h_k}(z_k) \cdot |d\tilde{u}(z_k)|_k \rightarrow \infty$. Using Lemma 5.2.4, choose a sequence of holomorphic embeddings

$$\varphi_k : \mathbb{D} \hookrightarrow \dot{\Sigma}^D$$

such that $|d\varphi_k|_k$, the radii of the disks $\varphi_k(\mathbb{D})$ and the injectivity radius satisfy the bounds specified in the lemma. Let

$$\rho_k = \min \{ |\zeta| \mid \zeta \in \varphi_k^{-1}(\partial\Sigma) \},$$

or $\rho_k = \infty$ if $\varphi_k(\mathbb{D}) \cap \partial\Sigma = \emptyset$. The sequence ρ_k determines whether or not we can restrict the embeddings φ_k in a uniform way so that their images are in $\dot{\Sigma}$.

Case 1: assume there is a number $\rho \in (0, 1]$ and a subsequence for which $\rho_k \geq \rho$. Then the restrictions of φ_k to \mathbb{D}_ρ are embeddings into $\dot{\Sigma}$, and we can define a sequence of pseudoholomorphic disks

$$\tilde{v}_k = (b_k, v_k) = \tilde{u}_k \circ \varphi_k : \mathbb{D}_\rho \rightarrow \mathbb{R} \times S^3,$$

which satisfy a uniform energy bound

$$E_k(\tilde{v}_k) = \sup_{\varphi \in \mathcal{T}} \int_{\mathbb{D}_\rho} \tilde{v}_k^* d(\varphi \lambda_k) \leq E_k(\tilde{u}_k) \leq C.$$

Denoting the Euclidean metric on \mathbb{D} by η , the fact that $\varphi_k : (\mathbb{D}_\rho, \eta) \rightarrow (\dot{\Sigma}, h_k)$ is conformal implies that the norms of $d\varphi_k(z)$ and its inverse are reciprocals. Then a simple computation shows

$$|\nabla \tilde{v}_k(0)| = |d\tilde{u}_k(z_k)|_k \cdot |d\varphi_k(0)|_k \geq c_1 |d\tilde{u}_k(z_k)|_k \cdot \text{inrad}_{h_k}(z_k) \rightarrow \infty.$$

By Lemma 4.6.5, we can choose a new sequence $\zeta_k \in \mathbb{D}_\rho$ and positive numbers $\epsilon \rightarrow 0$ such that $R_k := |\nabla \tilde{v}(z_k)| \rightarrow \infty$, $\epsilon_k R_k \rightarrow \infty$ and $|\nabla \tilde{v}(\zeta)| \leq 2R_k$ for all $\zeta \in \mathbb{D}_\rho$ with $|\zeta - \zeta_k| \leq \epsilon_k$. Assume without loss of generality that $\overline{B_{\epsilon_k}(\zeta_k)} \subset \mathbb{D}_\rho$ and define

$$\psi_k : \mathbb{D}_{\epsilon_k R_k} \rightarrow \overline{B_{\epsilon_k}(\zeta_k)} : \zeta \rightarrow \zeta_k + \frac{\zeta}{R_k}.$$

Now, if there is a subsequence for which $b_k(\zeta_k)$ is bounded, define a rescaled sequence of \tilde{J}_k -holomorphic maps $\tilde{w}_k = (\beta_k, w_k) : \mathbb{D}_{\epsilon_k R_k} \rightarrow \mathbb{R} \times S^3$ by

$$(\beta_k(\zeta), w_k(\zeta)) = (b_k \circ \psi_k(\zeta), v_k \circ \psi_k(\zeta)).$$

We change this slightly if $|b_k(\zeta_k)| \rightarrow \infty$ and define

$$(\beta_k(\zeta), w_k(\zeta)) = (b_k \circ \psi_k(\zeta) - b_k(\zeta_k), v_k \circ \psi_k(\zeta)).$$

In either case, these maps satisfy the uniform gradient bound $|\nabla \tilde{w}_k(\zeta)| \leq 2$ and they all map 0 into a compact subset of $\mathbb{R} \times S^3$, thus a subsequence converges in C_{loc}^∞ to a \tilde{J}_∞ -holomorphic plane

$$\tilde{w}_\infty = (\beta_\infty, w_\infty) : \mathbb{C} \rightarrow \mathbb{R} \times S^3.$$

In the case where $b_k(\zeta_k)$ is bounded, define the energy of \tilde{w}_∞ by

$$E_\infty(\tilde{w}_\infty) = \sup_{\varphi \in \mathcal{T}} \int_{\mathbb{C}} \tilde{w}_\infty^* d(\varphi \lambda_\infty).$$

This is finite, since for any large disk $\mathbb{D}_R \subset \mathbb{C}$, we have $\mathbb{D}_R \subset \mathbb{D}_{\epsilon_k R_k}$ for sufficiently large k , and

$$\begin{aligned} \int_{\mathbb{D}_R} \tilde{w}_\infty^* d(\varphi \lambda_\infty) &= \lim_{k \rightarrow \infty} \int_{\mathbb{D}_R} \tilde{w}_k^* d(\varphi \lambda_k) \leq \lim_{k \rightarrow \infty} \int_{\mathbb{D}_{\epsilon_k R_k}} \psi_k^* \tilde{v}_k^* d(\varphi \lambda_k) \\ &= \lim_{k \rightarrow \infty} \int_{B_{\epsilon_k}(\zeta_k)} \tilde{v}_k^* d(\varphi \lambda_k) \leq \sup_k \int_{\mathbb{D}} \tilde{v}_k^* d(\varphi \lambda_k) \leq C. \end{aligned}$$

If on the other hand $|b_k(\zeta_k)| \rightarrow \infty$, we change the definition of $E_\infty(\tilde{w}_\infty)$ to use one of the asymptotic taming sets \mathcal{T}^\pm instead of \mathcal{T} , and then find a similar bound using the asymptotic \mathbb{R} -invariance axiom (cf. the proof of Theorem 4.6.4). We conclude that \tilde{w}_∞ is a non-constant finite energy plane. The puncture at ∞ cannot be removable: since \tilde{J}_∞ is tamed by the exact symplectic form $d(e^a \lambda_\infty)$, every closed holomorphic curve is constant. Therefore \tilde{w}_∞ is asymptotic to some periodic orbit P of X_{λ_∞} . We now use a topological argument to show that this is impossible.

If P is geometrically distinct from P_∞ , then $\text{lk}(P, P_\infty) \neq 0$ by assumption. For some large radius R , the image $w_\infty(\partial\mathbb{D}_R)$ is uniformly close to P , and we may assume the same is true of $P' := w_k(\partial\mathbb{D}_R)$ for sufficiently large k , thus $\text{lk}(P', P_\infty) \neq 0$. But since w_k is a reparametrization of $u_k : \dot{\Sigma} \rightarrow S^3$ over some disk, this means there is a disk $\mathcal{D} \subset \dot{\Sigma}$ such that $P' = u(\partial\mathcal{D})$. The linking condition then implies that $u(\mathcal{D})$ intersects P_∞ , contradicting the assumptions of the theorem.

Suppose now that P is identical to P_∞ or some cover thereof. For any component $K_j \subset K$, observe that $u_k(\dot{\Sigma})$ never intersects K_j . Then repeating the argument above, we find a disk $\mathcal{D} \subset \dot{\Sigma}$ such that for sufficiently large k , $u_k(\partial\mathcal{D})$ is a knot uniformly close to P_∞ . This implies $\text{lk}(P_\infty, K_j) = 0$, also contradicting the assumptions of the theorem, thus proving that the plane \tilde{w}_∞ cannot exist.

Case 2: assume $\rho_k \rightarrow 0$. Here we will find that either a plane or a disk bubbles off, depending on how fast ρ_k approaches 0. Choose a sequence $\zeta'_k \in \mathbb{D}$ such that $\zeta_k := \varphi_k(\zeta'_k) \in \partial\Sigma$ and $|\zeta'_k| = \rho_k$. By Remark 5.2.5, we can find a sequence of holomorphic embeddings

$$\varphi_k^+ : \mathbb{D}^+ \hookrightarrow \dot{\Sigma}$$

that map 0 to ζ_k and $\mathbb{D}^+ \cap \mathbb{R}$ into $\partial\Sigma$, and satisfy the bounds specified in Lemma 5.2.4. We claim there is a sequence of radii $r_k \rightarrow 0$ such that $z_k \in \varphi_k^+(\mathbb{D}_{r_k}^+)$. Indeed, from Lemma 5.2.4, we know that $\varphi^+(\mathbb{D}_{r_k}^+)$ contains all points $\zeta \in \dot{\Sigma}$ with $\text{dist}_{h_k}(\zeta, \zeta_k) \leq d_k$, where

$$d_k \geq c_2 r_k \cdot \text{inrad}_{h_k}(\zeta_k).$$

We have also the estimates

$$\begin{aligned} \text{dist}_{h_k}(z_k, \zeta_k) &\leq C_2 \rho_k \cdot \text{inrad}_{h_k}(z_k), \\ \text{inrad}_{h_k}(\zeta_k) &\geq (c_3 - c_4 \rho_k) \cdot \text{inrad}_{h_k}(z_k). \end{aligned}$$

Then when ρ_k is sufficiently small we can set

$$r_k = \frac{2C_2}{c_2(c_3 - c_4 \rho_k)} \rho_k$$

and compute,

$$\text{dist}_{h_k}(\zeta_k, z_k) \leq \frac{C_2}{c_3 - c_4 \rho_k} \rho_k \cdot \text{inrad}_{h_k}(\zeta_k) = \frac{1}{2} c_2 r_k \text{inrad}_{h_k}(\zeta_k) < d_k.$$

We can thus choose a sequence $z'_k \in \mathbb{D}^+$ with $z'_k \rightarrow 0$ and $\varphi_k^+(z'_k) = z_k$. Defining a sequence of \tilde{J}_k -holomorphic half-disks

$$\tilde{v}_k = \tilde{u}_k \circ \varphi^+ : \mathbb{D}^+ \rightarrow \mathbb{R} \times S^3,$$

we have

$$\begin{aligned} R_k &:= |\nabla \tilde{v}_k(z'_k)| = |d\tilde{u}_k(z_k)|_k \cdot |d\varphi^+(z'_k)|_k \geq C |d\tilde{u}_k(z_k)|_k \cdot \text{injr}_{h_k}(\zeta_k) \\ &\geq C(c_3 - c_4\rho_k) |d\tilde{u}_k(z_k)|_k \cdot \text{injr}_{h_k}(z_k) \rightarrow \infty. \end{aligned}$$

Using Lemma 4.6.5, we may assume there is a sequence of positive numbers $\epsilon_k \rightarrow 0$ such that $\epsilon_k R_k \rightarrow \infty$ and $|\nabla \tilde{v}_k(z)| \leq 2R_k$ for all $z \in \mathbb{D}^+$ with $|z - z'_k| \leq \epsilon_k$. Writing $z'_k = s_k + it_k$, there are two possibilities:

Case 2a: assume $t_k R_k$ is unbounded. Passing to a subsequence, we may assume $t_k R_k \rightarrow \infty$, thus $r'_k := \min\{\epsilon_k R_k, t_k R_k\} \rightarrow \infty$. Then for sufficiently large k we can define embeddings $\psi_k : \mathbb{D}_{r'_k} \hookrightarrow \mathbb{D}^+$ by

$$\psi_k(z) = z_k + \frac{z}{R_k}.$$

Arguing as in case 1, there is now a sequence of rescaled maps

$$\tilde{w}_k = (\beta_k, w_k) = \tilde{v}_k \circ \psi_k : \mathbb{D}_{r'_k} \rightarrow \mathbb{R} \times S^3$$

and constants $c_k \in \mathbb{R}$ such that a subsequence of $(\beta_k + c_k, w_k)$ converges in C_{loc}^∞ to a \tilde{J}_∞ -holomorphic finite energy plane $\tilde{w}_\infty = (\beta_\infty, w_\infty) : \mathbb{C} \rightarrow \mathbb{R} \times S^3$, asymptotic to a periodic orbit P . Just as in case 1, we argue that this plane cannot exist, because it would imply either $\text{lk}(P, P_\infty) = 0$ or $\text{lk}(P_\infty, K_j) = 0$ for K_j a component of K .

Case 2b: assume $t_k R_k$ is bounded. Now define $\psi_k : \mathbb{D}_{\epsilon_k R_k}^+ \hookrightarrow \mathbb{D}^+$ by

$$\psi_k(z) = s_k + \frac{z}{R_k},$$

and let

$$\tilde{w}_k = (\beta_k, w_k) = \tilde{v}_k \circ \psi_k : \mathbb{D}_{\epsilon_k R_k}^+ \rightarrow \mathbb{R} \times S^3.$$

Then $|\nabla \tilde{w}_k|$ is uniformly bounded. If there is a subsequence for which $\beta_k(0)$ is bounded, then we may assume $\tilde{w}_k \rightarrow \tilde{w}_\infty$ in C_{loc}^∞ , where

$$\tilde{w}_\infty = (\beta_\infty, w_\infty) : \mathbb{H} \rightarrow \mathbb{R} \times S^3,$$

is a \tilde{J}_∞ -holomorphic half-plane with finite energy

$$\sup_{\varphi \in \mathcal{T}} \int_{\mathbb{H}} \tilde{w}_\infty^* d(\varphi \lambda_\infty) < \infty.$$

It also satisfies the boundary condition $\tilde{w}_\infty(\mathbb{R}) \subset \tilde{L}_j^\sigma$ for some $\sigma \in \mathbb{R}$. To see this, note first that $w_\infty(\mathbb{R}) \subset L_j$ since L_j is compact. Then if $F : \mathbb{R} \times L_j \rightarrow \mathbb{R}$ is the smooth function defined by $F(p) = \sigma$ for $p \in \tilde{L}_j^\sigma$, we have a compact sequence of constant functions $F \circ \tilde{w}_k|_{\mathbb{R}} : \mathbb{R} \cap \mathbb{D}_{\epsilon_k R_k}^+ \rightarrow \mathbb{R}$, converging therefore to a constant function.

If $|\beta_k(0)| \rightarrow \infty$, we instead define \tilde{w}_∞ as the limit of some subsequence of $(\beta_k - \beta_k(0), w_k)$. Then since the boundary condition is asymptotically \mathbb{R} -invariant, $\tilde{w}_\infty(\mathbb{R})$ belongs to some \mathbb{R} -invariant family of pseudo-Lagrangian tori, and \tilde{w}_∞ has finite energy with respect to one of the asymptotic taming sets \mathcal{T}^\pm :

$$\sup_{\varphi \in \mathcal{T}^\pm} \int_{\mathbb{H}} \tilde{w}_\infty^* d(\varphi \lambda_\infty) < \infty$$

(cf. the proof of Prop. 4.6.17 for more detailed accounts of these energy estimates).

In either case, we have a finite energy half-plane $\tilde{w}_\infty : \mathbb{H} \rightarrow \mathbb{R} \times S^3$ solving some version of Problem **(BP)**. It is not constant, since $|\nabla \tilde{w}_k(it_k R_k)| = \frac{1}{R_k} |\nabla \tilde{v}_k(s_k + it_k)| = 1$ and a subsequence of $it_k R_k$ converges in \mathbb{D}^+ . Now identifying \mathbb{H} conformally with $\mathbb{D} \setminus \{1\}$, we can regard \tilde{w}_∞ as a holomorphic disk with a puncture on the boundary, and Theorem 4.6.16 tells us that the puncture is removable. Thus extending over the puncture defines a \tilde{J}_∞ -holomorphic disk

$$\tilde{w} = (\beta, w) : \mathbb{D} \rightarrow \mathbb{R} \times S^3$$

with $w(\partial\mathbb{D}) \subset L_j$. By topological considerations, we can severely restrict the homotopy class of the loop $\gamma = w|_{\partial\mathbb{D}} : \partial\mathbb{D} \rightarrow L_j$. Indeed, choose a radius r slightly less than 1 so that $w|_{\partial\mathbb{D}_r} : \partial\mathbb{D}_r \rightarrow S^3$ is uniformly close to γ . Returning to the half-plane \mathbb{H} , there is then a large simply connected region $\Omega \subset \mathbb{H}$ with smooth boundary such that for large k , $w_k|_{\partial\Omega} : \partial\Omega \rightarrow S^3$ is also uniformly close to γ . Undoing the reparametrization one step further, there is then an embedded disk $\mathcal{D} \subset \tilde{\Sigma}$ such that for some large k ,

$$u_k|_{\partial\mathcal{D}} : \partial\mathcal{D} \rightarrow S^3$$

is uniformly close to γ . Since u_k does not intersect either P_∞ or any of the knots $K_j \subset K$, this implies

$$\text{lk}(\gamma, P_\infty) = \text{lk}(\gamma, K_1) = \dots = \text{lk}(\gamma, K_m) = 0.$$

This is only possible if γ is contractible on L_j . But this implies that the Maslov index $\mu(\tilde{w})$ is zero. By Corollary 4.3.9, a disk with $\pi T w$ not identically zero must have $\mu(\tilde{w}) \geq 2$, therefore $\pi T w \equiv 0$, which means

$$\int_{\mathbb{D}} w^* d\lambda_\infty = 0.$$

But by Prop. 4.6.18, this implies that \tilde{w} is constant, a contradiction. \square

The arguments used so far to exclude bubbling are already almost enough to prove the compactness theorem in the cases where $\partial\Sigma$ is either empty or connected.

Proposition 5.2.6. *Theorem 5.2.2 holds if $\chi(\dot{\Sigma}) \geq 0$.*

Proof. This includes two cases: $\dot{\Sigma}$ is diffeomorphic to either a plane or a singly punctured disk. In both cases the space of conformal structures on the domain is trivial, so we can assume $(\dot{\Sigma}, j_k)$ is either (\mathbb{C}, i) or $(\mathbb{C} \setminus \mathcal{D}, i)$ for all k , where $\mathcal{D} = \text{int } \mathbb{D}$. We then have a sequence of maps $\tilde{u}_k = (a_k, u_k) : \dot{\Sigma} \rightarrow \mathbb{R} \times S^3$ satisfying $T\tilde{u}_k \circ i = \tilde{J}_k \circ T\tilde{u}$, all positively asymptotic at $\infty \in \Sigma$ to the simply covered orbit P_∞ with period T . In the case $\dot{\Sigma} = \mathbb{C}$, Stokes' theorem implies $\int_{\mathbb{C}} u_k^* d\lambda_k = T$ for all k , and we can assume the parametrization is chosen such that

$$\int_{\mathbb{D}} u_k^* d\lambda_k = \frac{T}{2}.$$

In the case with boundary, there is a knot K contained in a solid torus $N \subset S^3 \setminus P_\infty$ such that $\text{lk}(K, P_\infty) > 0$, and u_k maps $\partial\Sigma$ to an oriented knot $\gamma \subset L = \partial N$ with $\text{lk}(\gamma, K) = -1$.

Assume first that $|\nabla \tilde{u}_k(z)|$ is uniformly bounded (using the Euclidean metric on \mathbb{C}). Then there are constants $c_k \in \mathbb{R}$ such that the translated maps $(a_k + c_k, u_k)$ have a subsequence C_{loc}^∞ -convergent to a \tilde{J}_∞ -holomorphic map $\tilde{u}_\infty : \dot{\Sigma} \rightarrow \mathbb{R} \times S^3$, which (by the usual arguments) has finite energy and satisfies the appropriate boundary condition. Then it remains to prove that \tilde{u}_∞ has a positive puncture at ∞ , asymptotic to P_∞ with covering number 1. For the case $\dot{\Sigma} = \mathbb{C}$, our choice of parametrization gives

$$\int_{\mathbb{C}} u_\infty^* d\lambda_\infty \geq \int_{\mathbb{D}} u_\infty^* d\lambda_\infty = \lim_k \int_{\mathbb{D}} u_k^* d\lambda_k = \frac{T}{2},$$

thus \tilde{u}_∞ is not constant, and the puncture is therefore not removable. For $\partial\Sigma \neq \emptyset$ we can prove the same thing by observing that a removable puncture would give a holomorphic disk

$$\mathbb{D} \rightarrow \mathbb{R} \times S^3 : z \mapsto \tilde{u}_\infty(1/z)$$

mapping $\partial\mathbb{D}$ to a meridian on L , thus u_∞ (and hence u_k for large k) would have to intersect K .

Having excluded the possibility of a removable puncture, we know \tilde{u}_∞ is asymptotic to some periodic orbit P at ∞ . If P is geometrically distinct from P_∞ and $\dot{\Sigma} = \mathbb{C}$, we can repeat the linking argument used in Prop. 5.2.3 and show that $\text{lk}(P, P_\infty) = 0$, a contradiction. This also works when $\dot{\Sigma} = \mathbb{C} \setminus \mathcal{D}$, because \tilde{u}_∞

extends as a smooth map over \mathbb{C} , taking \mathcal{D} into the solid torus N . The other possibility is that P could be an n -fold cover of P_∞ with $n \neq 0$. (The covering number n may be negative, meaning that ∞ becomes a negative puncture; this is possible *a priori* if $\partial\Sigma \neq \emptyset$). In the case $\dot{\Sigma} = \mathbb{C} \setminus \mathcal{D}$, we have $u_k(\dot{\Sigma}) \cap K = \emptyset$ for all k , so if k is sufficiently large, a small perturbation of u_k realizes a homology $\partial[u_k] = n[P_\infty] + [\gamma]$ in $S^3 \setminus K$, consequently

$$n \cdot \text{lk}(P_\infty, K) = -\text{lk}(\gamma, K) = 1.$$

Then n can only be 1. In the case $\dot{\Sigma} = \mathbb{C}$, n must be positive since every finite energy plane has a positive puncture. We use Stokes' theorem to compute the contact areas of \tilde{u}_∞ and \tilde{u}_k :

$$\mathcal{A}_{\lambda_k}(\tilde{u}_k) = \int_{\mathbb{C}} u_k^* d\lambda_k = T \quad \text{and} \quad \mathcal{A}_{\lambda_\infty}(\tilde{u}_\infty) = \int_{\mathbb{C}} u_\infty^* d\lambda_\infty = nT.$$

Then since $\tilde{u}_k \rightarrow \tilde{u}_\infty$ on compact subsets, we also have $\mathcal{A}_{\lambda_\infty}(\tilde{u}_\infty) \leq \lim_k \mathcal{A}_{\lambda_k}(\tilde{u}_k) = T$, so n cannot be greater than 1. This proves the result in the presence of uniform gradient bounds.

Assume now that there is a sequence $z_k \in \dot{\Sigma}$ such that $|\nabla \tilde{u}_k(z_k)| \rightarrow \infty$. If $\dot{\Sigma} = \mathbb{C}$, then by the usual arguments, we can define a sequence of rescaled maps $\tilde{v}_k = (b_k, v_k) : \mathbb{C} \rightarrow \mathbb{R} \times S^3$ by

$$\tilde{v}_k(z) = \tilde{u}_k \left(z_k + \frac{z}{R_k} \right),$$

and find constants $c_k \in \mathbb{R}$ such that a subsequence of $(b_k + c_k, v_k)$ converges to a non-constant finite energy plane \tilde{v}_∞ . Then repeating the argument above with linking numbers and contact area, the asymptotic limit of \tilde{v}_∞ must be P_∞ .

In the case $\dot{\Sigma} = \mathbb{C} \setminus \mathcal{D}$, it turns out that the gradient cannot blow up. The proof is much the same as in Prop. 5.2.3: we define rescaled maps \tilde{v}_k on an increasing sequence of either disks or half-disks, depending on whether and how fast z_k approaches the boundary. These then have a subsequence convergent to a non-constant finite energy plane or half-plane \tilde{v}_∞ . By the usual linking arguments, if \tilde{v}_∞ is a plane it would have to intersect either P_∞ or K , neither of which is allowed. For the half-plane case, \tilde{v} extends to a non-constant pseudoholomorphic disk, and the same argument as before shows that $\tilde{v}(\partial\mathbb{D})$ is contractible on L , thus its Maslov index is 0, and it must therefore have vanishing contact area, another contradiction. \square

5.2.2 Convergence of conformal structures

Thanks to Prop. 5.2.6, we can from now on assume $\chi(\dot{\Sigma}) < 0$, so in the terminology of Appendix B, $(\Sigma, j_k, \{\infty\})$ is a sequence of stable Riemann surfaces with boundary and one interior marked point. By Prop. 5.2.3, the pseudoholomorphic maps $\tilde{u}_k = (a_k, u_k) : (\dot{\Sigma}, j_k) \rightarrow (\mathbb{R} \times S^3, \tilde{J}_k)$ satisfy the bound

$$|d\tilde{u}_k(z)|_k \leq C \cdot \text{inrad}_{h_k}(z),$$

where h_k is the Poincaré metric on $(\dot{\Sigma}, j_k)$. The main hurdle remaining in the proof of Theorem 5.2.2 is to show that j_k is a compact sequence.

Proposition 5.2.7. *There is a smooth complex structure j_∞ on Σ and a sequence of diffeomorphisms $\varphi_k : \Sigma \rightarrow \Sigma$ fixing ∞ and preserving each component of $\partial\Sigma$, such that a subsequence of $\varphi_k^* j_k$ converges to j_∞ in the C^∞ -topology.*

There are also constants $c_k \in \mathbb{R}$ such that the maps $(a_k + c_k, u_k) \circ \varphi_k : (\dot{\Sigma}, \varphi_k^ j_k) \rightarrow (\mathbb{R} \times S^3, \tilde{J}_k)$ are solutions to Problem (BP), and a subsequence converges in C_{loc}^∞ to a pseudoholomorphic solution $\tilde{u}_\infty : (\dot{\Sigma}, j_\infty) \rightarrow (\mathbb{R} \times S^3, \tilde{J}_\infty)$ of (BP) which is positively asymptotic to P_∞ at the puncture.*

Proof. A subsequence of $(\Sigma, j_k, \{\infty\})$ converges to a stable nodal surface $\mathbf{S} = (S, j, \{p\}, \Delta, N)$, as described in Appendix B. Here (S, j) is a Riemann surface consisting of finitely many compact components $S = S_1 \cup \dots \cup S_n$, possibly with boundary, and the marked point $p \in \text{int } S$ is disjoint from the double points Δ and unpaired nodes N . A choice of decoration r defines the compact connected surface $\bar{\mathbf{S}}_r$, with a singular conformal structure $j_{\mathbf{S}}$ and singular Poincaré metric $h_{\mathbf{S}}$, both of which degenerate on a finite set of circles and arcs $\Theta_{\Delta, N} \subset \bar{\mathbf{S}}_r$. Then convergence means there is a decoration r and a sequence of diffeomorphisms

$$\varphi_k : \bar{\mathbf{S}}_r \rightarrow \Sigma$$

such that:

1. $\varphi_k(p) = \infty$.
2. $\varphi_k^* j_k \rightarrow j_{\mathbf{S}}$ in $C_{\text{loc}}^\infty(\bar{\mathbf{S}}_r \setminus \Theta_{\Delta, N})$.
3. All circles in $\varphi_k(\Theta_{\Delta, N})$ are closed geodesics in $(\dot{\Sigma}, h_k)$, and all arcs in $\varphi_k(\Theta_{\Delta, N})$ are geodesic arcs in $(\dot{\Sigma}, h_k)$ that intersect $\partial\Sigma$ transversely.

We can assume without loss of generality that the diffeomorphisms φ_k map a given component of $\partial(\bar{\mathbf{S}}_r)$ always to the *same* component of $\partial\Sigma$, i.e. $\varphi_k \circ \varphi_j^{-1}$ always maps each connected component $\gamma_j \subset \partial\Sigma$ to itself.

If S_j is a connected component of S , let \dot{S}_j be the punctured surface obtained by removing all points in the set $(\{p\} \cup \Delta \cup N) \cap S_j$. Note that the stability condition implies $\chi(\dot{S}_j^D) < 0$. There is a natural embedding $\dot{S}_j \hookrightarrow \overline{\mathbf{S}}_r \setminus \Theta_{\Delta, N}$, which we use to define the sequence of complex structures $\varphi_k^* j_k$ and metrics $\varphi_k^* h_k$ on \dot{S}_j . Then passing to a subsequence, we have $\varphi_k^* j_k \rightarrow j$ and $\varphi_k^* h_k \rightarrow h$ in C_{loc}^∞ on \dot{S}_j , where h is the Poincaré metric for (\dot{S}_j, j) . Since $d\tilde{u}_k$ is uniformly bounded on compact subsets and the boundary conditions are asymptotically \mathbb{R} -invariant, we can then find constants $c_k^j \in \mathbb{R}$ such that

$$\tilde{v}_k^j = (b_k^j, v_k^j) = (a_k + c_k^j, u_k) \circ \varphi_k|_{\dot{S}_j} : (\dot{S}_j, \varphi_k^* j_k) \rightarrow (\mathbb{R} \times S^3, \tilde{J}_k)$$

is a sequence of pseudoholomorphic maps satisfying the appropriate boundary conditions and a uniform C^1 -bound. Thus \tilde{v}_k^j has a C_{loc}^∞ -convergent subsequence

$$\tilde{v}_k^j \rightarrow \tilde{v}^j = (b^j, v^j) : \dot{S}_j \rightarrow \mathbb{R} \times S^3,$$

where \tilde{v}^j satisfies $T\tilde{v}^j \circ j = \tilde{J}_\infty \circ T\tilde{v}^j$. Due to the uniform energy bound for \tilde{u}_k , we see also that \tilde{v}^j has finite energy

$$E_\infty(\tilde{v}^j) = \sup_\varphi \int_{\dot{S}_j} (\tilde{v}^j)^* d(\varphi \lambda_\infty) < \infty,$$

where the sup is taken for functions φ belonging to either \mathcal{T} or (if $|c_k^j| \rightarrow \infty$) one of the asymptotic taming sets \mathcal{T}^\pm . Since the complex structure j extends smoothly over the punctures to S_j , we conclude that \tilde{v}^j is a \tilde{J}_∞ -holomorphic solution to Problem **(BP)**. Repeating this process for every component $S_j \subset S$, we obtain a set of \tilde{J}_∞ -holomorphic solutions

$$\begin{aligned} \tilde{v}^1 : \dot{S}_1 &\rightarrow \mathbb{R} \times S^3, \\ &\vdots \\ \tilde{v}^N : \dot{S}_n &\rightarrow \mathbb{R} \times S^3. \end{aligned}$$

Our main goal now is to show that \mathbf{S} is actually a smooth Riemann surface with boundary, i.e. Δ and N are empty sets and S has only one component. Then the set of solutions above reduces to a single solution $\tilde{u}_\infty : \dot{\Sigma} \rightarrow \mathbb{R} \times S^3$, which we must show is positively asymptotic to P_∞ at the puncture. As with the bubbling off arguments in the previous section, these results will follow mainly from topological considerations.

Recall from Remark 5.2.1 that it is sometimes convenient to label the component knots in $K = K_1 \cup \dots \cup K_m$ with some redundancy. That is, K_i and K_j may be

the same knot even if $i \neq j$; in particular we require a given component $K_i \subset K$ to repeat n times in the list K_1, \dots, K_m if $\text{lk}(K_i, P_\infty) = n$. (This linking number was assumed to be always positive.) The lists of components $N = N_1 \cup \dots \cup N_m$ and $L = L_1 \cup \dots \cup L_m$ are then defined with similar repetitions. Each of the maps $u_k : \dot{\Sigma} \rightarrow S^3$ has its image in $M = S^3 \setminus \text{int } N$, and if $\gamma_1, \dots, \gamma_m$ are the connected components of $\partial\Sigma$ (*not* repeated), then the oriented loop $u_k(\gamma_j)$ is a meridian on $L_j = \partial N_j$ with $\text{lk}(u_k(\gamma_j), K_j) = -1$. Thus the linking number $\text{lk}(K_j, P_\infty)$ is the number of distinct components of $\partial\Sigma$ mapped into the same torus L_j , and we have also $\text{lk}(u_k(\gamma_j), K) = -1$ since $u_k(\gamma_j)$ is unlinked with all components of K that are distinct from K_j . Adding this up for all $\gamma_j \subset \partial\Sigma$, we see that the expression

$$-\text{lk}(u_k(\partial\Sigma), K)$$

counts the connected components of $\partial\Sigma$. Also, the map u_k realizes a homology $\partial[u_k] = [P_\infty] + [u_k(\partial\Sigma)]$ in $S^3 \setminus K$, which gives the useful formula

$$\text{lk}(K_j, P_\infty) = -\text{lk}(K_j, u_k(\partial\Sigma)). \quad (5.2.6)$$

In light of this topological setup, u_k extends to a smooth map

$$\bar{u}_k : \mathbb{C} \rightarrow \mathbb{R} \times S^3$$

which satisfies $T\bar{u}_k \circ j_k = \tilde{J}_k \circ T\bar{u}_k$ in $\dot{\Sigma} = \mathbb{C} \setminus (\mathcal{D}_1 \cup \dots \cup \mathcal{D}_m) \subset \mathbb{C}$, and maps each of the disks \mathcal{D}_j into N_j . We may assume that $\bar{u}_k|_{\mathcal{D}_j}$ has a single transverse positive intersection with K_j . Remember also that $\text{lk}(P, P_\infty) \neq 0$ for any periodic orbit P that is geometrically distinct from P_∞ .

Let $S_1 \subset S$ be the connected component that contains the marked point p . Then either p is a removable puncture for $\tilde{v}^1 = (b^1, v^1) : \dot{S}_1 \rightarrow \mathbb{R} \times S^3$, or else \tilde{v}^1 is asymptotic to a periodic orbit there. We settle this question first.

Claim: \tilde{v}^1 is positively asymptotic to P_∞ at p . If the puncture is removable, then we can find an oriented circle $C \subset \dot{S}_1$ winding clockwise around p such that $v^1(C)$ lies in an arbitrarily small neighborhood of some point in $S^3 \setminus K$. Then this neighborhood also contains $v_k^1(C) = u_k(\varphi_k(C))$ for sufficiently large k , and $\varphi_k(C)$ is a large circle in \mathbb{C} , bounding a simply connected region Ω . One can then extend u_k over Ω to a smooth map

$$\hat{u}_k : \mathbb{C} \rightarrow S^3 \setminus K,$$

with the loops $\hat{u}_k(\partial\mathbb{D}_R)$ approaching P_∞ as $R \rightarrow \infty$. This implies that for any component $K_j \subset K$, $\text{lk}(P_\infty, K_j) = 0$, a contradiction.

If p is a nonremovable puncture and \tilde{v}^1 is asymptotic to an orbit P that is geometrically distinct from P_∞ , we similarly find a large clockwise oriented circle

$\varphi_k(C) \subset \mathbb{C}$, bounding a region Ω , such that $u_k(\varphi_k(C))$ is close to P . Then the existence of the map $\bar{u}_k|_\Omega : \Omega \rightarrow S^3 \setminus P_\infty$ implies $\text{lk}(P, P_\infty) = 0$, and this is impossible. The alternative is that P could be an n -fold cover of P_∞ for some integer $n \neq 0$. (Negative n would mean the puncture is negative.) But then restricting u_k to the region outside of Ω gives a homotopy of $u_k(\varphi_k(C))$ to P_∞ in $S^3 \setminus K$, implying that for any component $K_j \subset K$,

$$n \cdot \text{lk}(P_\infty, K_j) = \text{lk}(u_k \circ \varphi_k(C), K_j) = \text{lk}(P_\infty, K_j),$$

so $n = 1$. This proves the claim.

With the asymptotic behavior at p understood, it remains to prove that \mathbf{S} has no double points or unpaired nodes.³ Note that it suffices to prove this for the component $S_1 \subset S$. Our approach will be to use topological constraints in conjunction with the properties of the holomorphic curve $\tilde{v}^1 : \tilde{S}_1 \rightarrow \mathbb{R} \times S^3$, in order to show that $\Delta \cap S_1$ and $N \cap S_1$ are empty. We shall set up this discussion in a slightly more general way than is immediately necessary, since it will also be useful for the noncompactness argument in the next section.

First some notation. The m connected components of $\partial\Sigma$ are denoted

$$\partial\Sigma = \gamma_1 \cup \dots \cup \gamma_m,$$

and let us write the components of ∂S_1 as

$$\partial S_1 = \alpha_1 \cup \dots \cup \alpha_s.$$

Note that $m \geq 2$ by assumption, but ∂S_1 could conceivably be empty. Assume S_1 has a (possibly empty) set of unpaired nodes

$$N \cap S_1 = \{w_1, \dots, w_\ell\},$$

interior double points

$$\Delta \cap \text{int } S_1 = \{z_1, \dots, z_q\},$$

and boundary double points

$$\Delta \cap \partial S_1 \supset \Delta \cap \alpha_j = \{\zeta_j^1, \dots, \zeta_j^{r_j}\} \quad \text{for } j = 1, \dots, s,$$

where we are regarding Δ for the moment as a set of *points* in S rather than pairs of points. We know from Theorem 4.6.16 that \tilde{v}^1 extends smoothly over each boundary

³The remainder of this proof has been revised slightly from the original version, which contained a gap resulting from an erroneous statement about boundary double points in Appendix B; the same remark applies to Step 3 in the proof of the stable case for Theorem 5.3.1. Thanks to Kai Cieliebak for pointing out the error.

double point $\zeta_j^i \in \Delta \cap \partial S_1$, and at each $z_j \in \Delta \cap \text{int } S_1$ and $w_j \in N \cap S_1$, \tilde{v}_1 either has a removable singularity or is asymptotic to some periodic orbit of X_{λ_∞} .

Recall the compact surface \overline{S}_1 (with piecewise smooth boundary), obtained from $S_1 \setminus ((\Delta \cup N) \cap S_1)$ by replacing all interior double points z_j and unpaired nodes w_j with “circles at infinity” δ_{z_j} and δ_{w_j} , and replacing each boundary double point ζ_j^i with an “arc at infinity” $\delta_{\zeta_j^i}$ (see Appendix B). Each component $\alpha_j \subset \partial S_1$ then gives rise to a piecewise smooth circular component $\bar{\alpha}_j \subset \partial \overline{S}_1$. There is a natural map $\overline{S}_1 \rightarrow \overline{\mathbf{S}}_r$, which is an inclusion except possibly on $\partial \overline{S}_1$, where two distinct circles δ_{z_j} or arcs $\delta_{\zeta_j^i}$ may have the same image; this corresponds to the identification of double points in a pair. Since $\overline{\mathbf{S}}_r$ is diffeomorphic to

$$\Sigma = \mathbb{C} \cup \{\infty\} \setminus (\mathcal{D}_1 \cup \dots \cup \mathcal{D}_m),$$

we can visualize $\overline{\mathbf{S}}_r \setminus \{p\}$ as the plane with a finite set of disks removed. An example of this is shown in Figure 5.6. Here we settle on the convention that—unlike the discussion of $\overline{\Sigma}$ in Chapter 4—the circles δ_{z_j} are always oriented as components of ∂S_1 . Thus they appear as embedded loops winding *clockwise* in the plane, and each encloses a bounded region which may contain some of the disks \mathcal{D}_i . Let m_j be the number of such disks enclosed by δ_{z_j} . Similarly, for $j = 1, \dots, s$, denote by \hat{m}_j the number of disks in the compact region enclosed by $\bar{\alpha}_j$; this number is always at least 1. Figure 5.6 shows a compact subset of $\overline{\mathbf{S}}_r$ which contains the entire boundary of \overline{S}_1 . Here the closure of the white area is \overline{S}_1 , and the lightly shaded regions constitute the rest of $\overline{\mathbf{S}}_r$, while the darkly shaded regions are the disks \mathcal{D}_j .

The integers defined above are related by

$$m = \ell + \sum_{j=1}^q m_j + \sum_{j=1}^s \hat{m}_j, \quad (5.2.7)$$

and as remarked above,

$$\hat{m}_j \geq 1 \quad \text{for all } j = 1, \dots, s. \quad (5.2.8)$$

There are also constraints imposed by the stability condition for each component of S : the double of \hat{S}_1 must have negative Euler characteristic, thus

$$2(s + q + \ell) + \sum_{j=1}^s r_j > 2, \quad (5.2.9)$$

and applying similar reasoning to the portions of $\overline{\mathbf{S}}_r$ inside the loops δ_{z_j} , we have

$$m_j \geq 2 \quad \text{for all } j = 1, \dots, q. \quad (5.2.10)$$

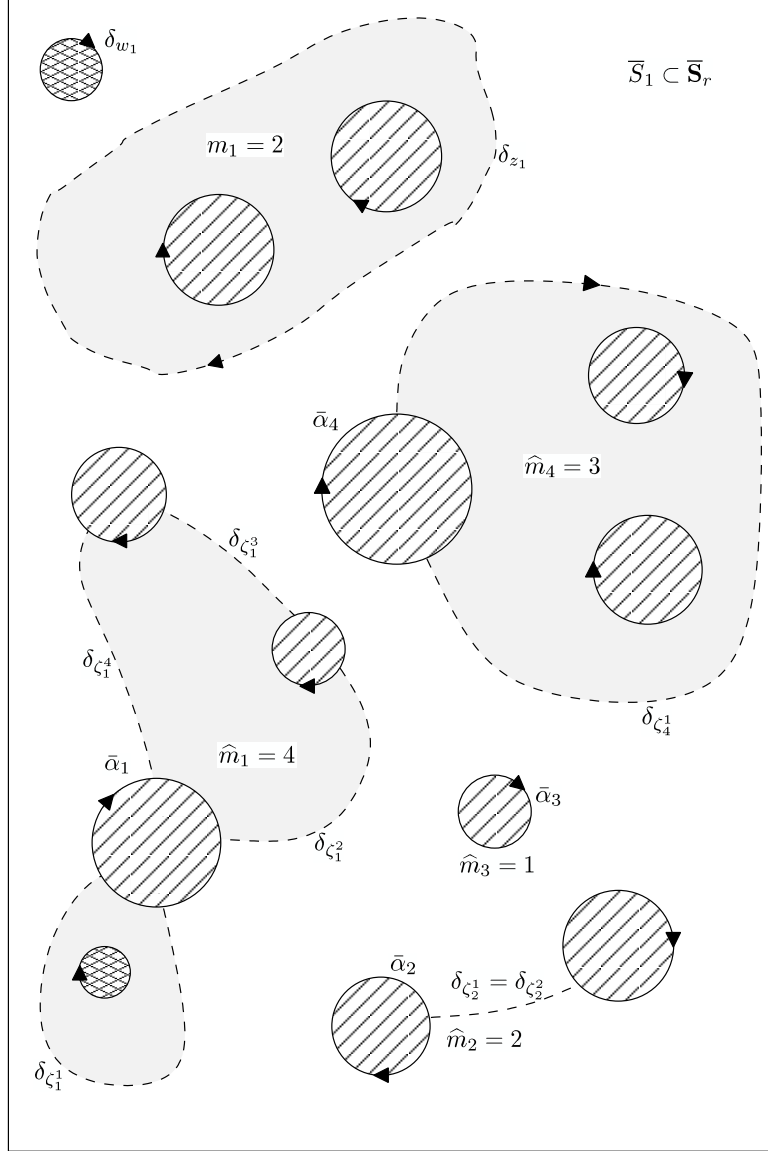

Figure 5.6: A compact subset of \bar{S}_r showing the piecewise smooth boundary of $\partial\bar{S}_1$. Here we assume ∂S_1 has four components $\alpha_1, \dots, \alpha_4$, S_1 has one interior double point $\Delta \cap \text{int } S_1 = \{z_1\}$, seven boundary double points $\Delta \cap \alpha_1 = \{\zeta_1^1, \dots, \zeta_1^4\}$, $\Delta \cap \alpha_2 = \{\zeta_2^1, \zeta_2^2\}$, $\Delta \cap \alpha_3 = \emptyset$, $\Delta \cap \alpha_4 = \{\zeta_4^1\}$, and one unpaired node $N \cap S_1 = \{w_1\}$.

We now transfer this picture onto $\dot{\Sigma}$ via the diffeomorphism

$$\varphi_k : \overline{S}_r \setminus \{p\} \rightarrow \dot{\Sigma}$$

for large k (see Figure 5.7). For $j = 1, \dots, q$, denote by $\partial_j \Sigma$ the m_j components of $\partial \Sigma$ that are enclosed within $\varphi_k(\delta_{z_j})$, and for $j = 1, \dots, s$ let $\hat{\partial}_j \Sigma$ be the \hat{m}_j components in the closed region bounded by $\varphi_k(\bar{\alpha}_j)$. Now for each component $\alpha_j \subset \partial S_1$, we define a perturbed loop $\alpha'_j \subset \text{int } S_1$ which misses the double points. The images $\varphi_k(\alpha'_j) \subset \dot{\Sigma}$ are represented as dotted loops in Figure 5.7; each encloses a bounded region that contains $\hat{\partial}_j \Sigma$. Similarly, for each interior double point z_j we choose a perturbed loop $C_j \subset \text{int } \overline{S}_1$ near δ_{z_j} , so $\varphi_k(C_j)$ encloses $\partial_j \Sigma$. Define also the loops $\beta_j \subset \text{int } \overline{S}_1$ as perturbations of δ_{w_j} for unpaired nodes $w_j \in N \cap S_1$: thus each $\varphi_k(\beta_j)$ encloses a unique connected component $\gamma_{g(j)} \subset \partial \Sigma$. Observe that $\partial \Sigma$ is now the disjoint union

$$\partial \Sigma = \left(\bigcup_{j=1}^q \partial_j \Sigma \right) \cup \left(\bigcup_{j=1}^s \hat{\partial}_j \Sigma \right) \cup \left(\bigcup_{j=1}^{\ell} \gamma_{g(j)} \right).$$

The images under φ_k of the various perturbed loops are shown with dotted lines in Figure 5.7.

From this picture we can deduce some topological facts about the behavior of $v^1 : \dot{S}_1 \rightarrow S^3$ at its boundary and punctures. For a component $\alpha_j \subset \partial S_1$, we have $v^1(\alpha_j) \subset L_{f(j)}$ for some $f(j) \in \{1, \dots, m\}$, and we can assume $u_k \circ \varphi_k(\alpha'_j)$ is C^0 -close to $v^1(\alpha_j)$. Then restricting u_k to the bounded region inside $\varphi_k(\alpha'_j)$ realizes a homology

$$\partial[u_k] = -[u_k \circ \varphi_k(\alpha'_j)] + [u_k(\hat{\partial}_j \Sigma)]$$

in both $S^3 \setminus P_\infty$ and $S^3 \setminus K$. This implies

$$\text{lk}(u_k \circ \varphi_k(\alpha'_j), P_\infty) = \text{lk}(u_k(\hat{\partial}_j \Sigma), P_\infty) = 0,$$

and thus

$$\text{lk}(v^1(\alpha_j), P_\infty) = 0. \quad (5.2.11)$$

This means $v^1(\alpha_j)$ covers a meridian on $L_{f(j)}$, and its homotopy class can be deduced exactly via the linking number with K :

$$\text{lk}(v^1(\alpha_j), K) = \text{lk}(u_k \circ \varphi_k(\alpha'_j), K) = \text{lk}(u_k(\hat{\partial}_j \Sigma), K) = -\hat{m}_j.$$

Since $v^1(\alpha_j)$ is only linked with one component of K ,

$$\text{lk}(v^1(\alpha_j), K_{f(j)}) = -\hat{m}_j. \quad (5.2.12)$$

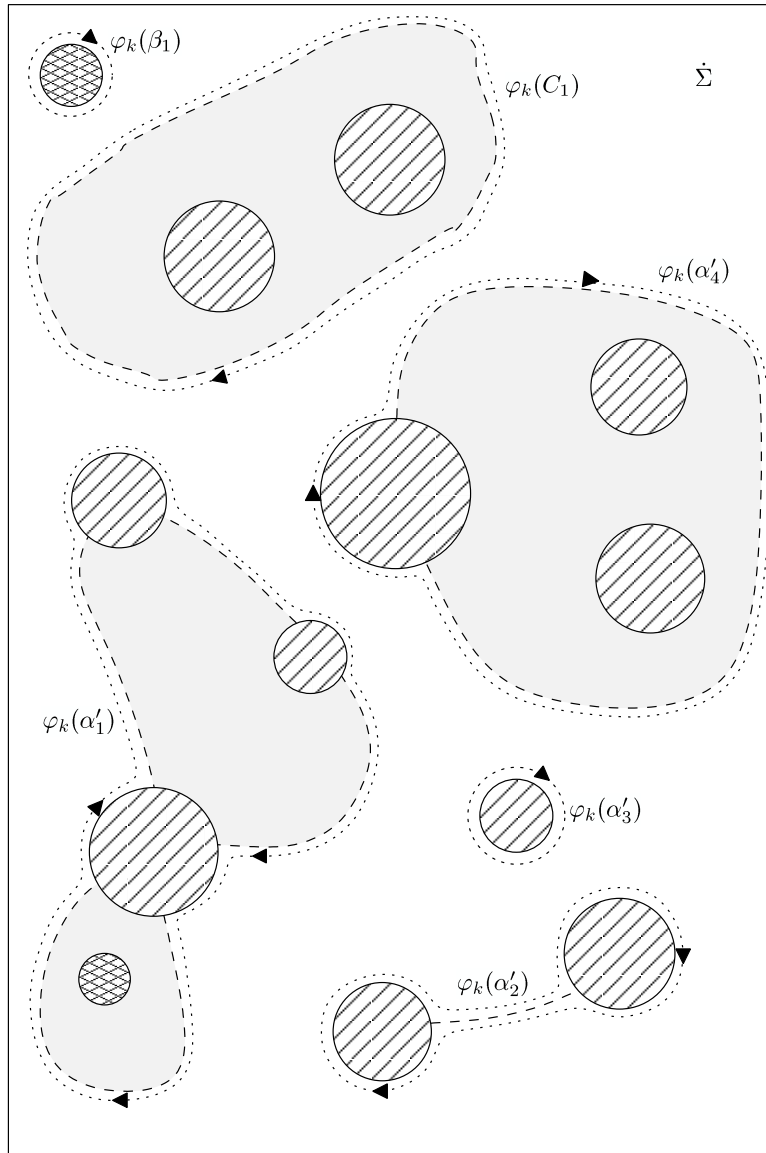

Figure 5.7: The image of Figure 5.6 under $\varphi_k : \bar{\mathbf{S}}_r \setminus \{p\} \rightarrow \dot{\Sigma}$, showing the perturbed loops $\alpha'_1, \dots, \alpha'_4, \beta_1$ and C_1 as dotted lines.

Turning our attention next to the unpaired nodes, let us assume there is a simply covered orbit $P_j \subset S^3$ of X_{λ_∞} such that \tilde{v}^1 is asymptotic to an $|n_j|$ -fold cover of P_j at $w_j \in N \cap S_1$, for some $n_j \in \mathbb{Z}$. Here we adopt the convention that the sign of n_j matches the sign of the puncture at w_j , and we set $n_j = 0$ if the puncture is removable (in which case it doesn't matter what P_j is). Now, restricting u_k to the region between $\gamma_{g(j)}$ and $\varphi_k(\beta_j)$, we have a homology

$$\partial[u_k] = [u_k(\gamma_{g(j)})] - [u_k \circ \varphi_k(\beta_j)],$$

in both $S^3 \setminus P_\infty$ and $S^3 \setminus K$, and we can assume $[u_k \circ \varphi_k(\beta_j)]$ is homologous to $n_j[P_j]$. Thus for every component $K_i \subset K$,

$$n_j \text{lk}(P_j, K_i) = \text{lk}(u_k(\gamma_{g(j)}), K_i). \quad (5.2.13)$$

Adding these up for all components of K , we find

$$n_j \text{lk}(P_j, K) = -1,$$

implying that the puncture is nonremovable and the orbit is simply covered. If $P_j = P_\infty$ this gives $n_j m = -1$, which cannot be true since $m \geq 2$ by assumption. Thus P_j is geometrically distinct from P_∞ , and using the homology in $S^3 \setminus P_\infty$, we have $n_j \text{lk}(P_j, P_\infty) = \text{lk}(u_k(\gamma_{g(j)}), P_\infty) = 0$, implying

$$\text{lk}(P_j, P_\infty) = 0. \quad (5.2.14)$$

We can reach similar conclusions about the behavior of \tilde{v}^1 at an interior double point $z_j \in \Delta \cap \text{int } S_1$. Using the same convention as above, assume v^1 approaches an $|n'_j|$ -fold cover of some simply covered orbit P'_j at z_j . Then we may assume $[u_k \circ \varphi_k(C_j)]$ is homologous to $n'_j[P'_j]$, and by restricting u_k over the bounded region inside $\varphi_k(C_j)$,

$$\partial[u_k] = [u_k(\partial_j \Sigma)] - [u_k \circ \varphi_k(C_j)]$$

in both $S^3 \setminus K$ and $S^3 \setminus P_\infty$. This implies for all components $K_i \subset K$,

$$n'_j \text{lk}(P'_j, K_i) = \text{lk}(u_k(\partial_j \Sigma), K_i), \quad (5.2.15)$$

and summing this over the components of K , we have

$$n'_j \text{lk}(P'_j, K) = -m_j \leq -2,$$

so n'_j cannot be zero, i.e. the puncture is not removable. If $P'_j = P_\infty$, we have $n'_j m = -m_j$, then $m_j \leq m$ implies $n'_j = -1$ and $m = m_j$. But this contradicts the stability assumption; indeed, combining (5.2.8), (5.2.10) and (5.2.7), we find $q = 1$

and $s = \ell = 0$, violating (5.2.9). Therefore P'_j is geometrically distinct from P_∞ , and the homology in $S^3 \setminus P_\infty$ gives $n'_j \text{lk}(P'_j, P_\infty) = \text{lk}(u_k(\partial_j \Sigma), P_\infty) = 0$, thus

$$\text{lk}(P'_j, P_\infty) = 0. \quad (5.2.16)$$

At this point all the vital ingredients are in place.

Claim: $N \cap S_1$ and $\Delta \cap S_1$ are empty. If $w_j \in N \cap S_1$, then v^1 is asymptotic to a periodic orbit P_j which is geometrically distinct from P_∞ , and is also unlinked with it, by (5.2.14). But we have assumed there is no such orbit, therefore $N \cap S_1 = \emptyset$. The same argument proves $\Delta \cap \text{int } S_1 = \emptyset$, using (5.2.16).

It remains only to exclude double points on the boundary. We now can assume that $\partial S_1 \neq \emptyset$ and the only puncture of \tilde{v}^1 is at p , where it is positively asymptotic to P_∞ . By assumption, there is a trivialization Φ_∞ of $(v^1)^* \xi_\infty|_M$ for which $\mu_{CZ}^{\Phi_\infty}(P_\infty) = 3$ and, using (5.2.12) and the fact that $v^1(\alpha_j)$ covers a meridian for each component $\alpha_j \subset \partial S_1$, the Maslov index along α_j is $2 \text{lk}(v^1(\alpha_j), K_{f(j)}) = -2\hat{m}_j$. Thus we compute

$$\mu(\tilde{v}^1) = 3 - 2 \sum_{j=1}^s \hat{m}_j.$$

The contact area of \tilde{v}^1 is clearly nonzero since $v^1(\partial S_1)$ and the image of v^1 near p cannot belong to the same Reeb orbit. Thus $\pi T v^1$ is not identically zero, and the wind_π estimate of Theorem 4.3.7 gives

$$\begin{aligned} 0 \leq 2 \text{wind}_\pi(\tilde{v}^1) &\leq \mu(\tilde{v}^1) - 2\chi(S_1) + 2(\#\Gamma_0) + \#\Gamma_1 \\ &= 3 - 2 \sum_{j=1}^s \hat{m}_j - 2(2 - s) + 1 = -2 \sum_{j=1}^s \hat{m}_j + 2s = 2 \sum_{j=1}^s (1 - \hat{m}_j). \end{aligned}$$

Since $\hat{m}_j \geq 1$ for all j , the right hand side of this expression is never positive, and is zero if and only if $\hat{m}_j = 1$ for all j . This excludes situations such as $\bar{\alpha}_1$ and $\bar{\alpha}_2$ in Figure 5.6, where double points give rise to arcs that connect two distinct disks. All the arcs in $\delta_{\zeta_j^i} \subset \partial \bar{S}_1$ must therefore begin and end on the same circle, enclosing a region of the plane as with $\bar{\alpha}_4$ in the figure. But now the stability condition requires this enclosed region to have negative Euler characteristic after doubling, which can only be true if it contains at least one disk, contradicting the fact that $\hat{m}_j = 1$. We conclude that there are no such arcs $\delta_{\zeta_j^i}$, and hence no double points $\zeta_j^i \in \Delta \cap \partial S_1$.

It follows now that \mathbf{S} has no double points or unpaired nodes at all, thus the convergence $(\Sigma, j_k, \{\infty\}) \rightarrow (S, j, \{p\}, \Delta, N)$ simply means there are diffeomorphisms $\varphi_k : S \rightarrow \Sigma$ such that $\varphi_k(p) = \infty$ and $\varphi_k^* j_k \rightarrow j$ in $C^\infty(S)$. Then after \mathbb{R} -translation, $\tilde{u}_k \circ \varphi_k \rightarrow \tilde{v}^1$ in $C_{\text{loc}}^\infty(S \setminus \{p\}, \mathbb{R} \times S^3)$, and \tilde{v}^1 has the same asymptotic limit as \tilde{u}_k . This completes the proof of Prop. 5.2.7, as well as Theorem 5.2.2. \square

5.3 Noncompactness: boundary \rightarrow puncture

We shall see now what happens to the sequence $\tilde{u}_k : \dot{\Sigma} \rightarrow \mathbb{R} \times S^3$ when the contact form is twisted to the point where “horizontal” orbits appear on the tori L_j . This will prevent the compactness result of Theorem 5.2.2, instead forcing each component of $\partial\Sigma$ to degenerate to a new puncture. Thus we obtain in the limit a finite energy surface without boundary.

Theorem 5.3.1. *Assume \tilde{u}_k , λ_k and J_k are exactly as in the assumptions of Theorem 5.2.2 for $k < \infty$, and $\partial\Sigma$ has $m > 0$ connected components. For $k = \infty$ we alter the assumptions on the contact form as follows:*

- *Any periodic orbit of X_{λ_∞} in $(\text{int } M) \setminus P_\infty$ satisfies $\text{lk}(P, P_\infty) \neq 0$. However, the tori $L_j \subset \partial M$ are simple Morse-Bott manifolds with respect to λ_∞ , foliated by periodic orbits P with $\text{lk}(P, P_\infty) = 0$ and $\text{lk}(P, K_j) = -1$.*

Then there is a finite set $\Gamma' \subset \mathbb{C}$ with $\#\Gamma' = m$, a sequence of numbers $c_k \in \mathbb{R}$ and diffeomorphisms $\varphi_k : S^2 \setminus \Gamma' \rightarrow \text{int } \Sigma$ that fix ∞ , such that $\varphi_k^ j_k \rightarrow i$ in $C_{\text{loc}}^\infty(S^2 \setminus \Gamma')$, the translations $(a_k + c_k, u_k)$ are solutions of **(BP)**, and a subsequence of $(a_k + c_k, u_k) \circ \varphi_k$ converges in $C_{\text{loc}}^\infty(\mathbb{C} \setminus \Gamma', \mathbb{R} \times S^3)$ to a \tilde{J}_∞ -holomorphic finite energy surface*

$$\tilde{u}_\infty : S^2 \setminus (\{\infty\} \cup \Gamma') \rightarrow \mathbb{R} \times S^3.$$

All the punctures of \tilde{u}_∞ are positive, the asymptotic limit at $\infty \in S^2$ is P_∞ , and for each component $\gamma_j \subset \partial\Sigma$ there is a corresponding puncture $z_j \in \Gamma'$ such that the asymptotic limit at z_j is a simply covered orbit on L_j .

The proof includes most of the same arguments that were used to prove Theorem 5.2.2, so we will not repeat these in any detail, but rather emphasize the aspects that are different in this situation. As before, it’s convenient to treat the stable and non-stable cases separately.

Proof in the non-stable case

Since we assumed $\partial\Sigma$ is nonempty, $(\Sigma, j_k, \{\infty\})$ is necessarily stable unless $\partial\Sigma$ has only one component. Thus for now, assume $(\dot{\Sigma}, j_k) = (\mathbb{C} \setminus \mathcal{D}, i)$ where $\mathcal{D} = \text{int } \mathbb{D}$. It will be convenient to use the biholomorphic map

$$\psi : \mathbb{R} \times S^1 \rightarrow \mathbb{C} \setminus \{0\} : (s, t) \mapsto e^{2\pi(s+it)}$$

and consider the sequence of \tilde{J}_k -holomorphic half-cylinders

$$\tilde{v}_k = (b_k, v_k) = \tilde{u}_k \circ \psi : [0, \infty) \times S^1 \rightarrow \mathbb{R} \times S^3,$$

with $v_k(\{s\} \times S^1) \rightarrow P_\infty$ as $s \rightarrow \infty$. We claim $|\nabla \tilde{v}_k|$ is uniformly bounded. The proof is almost identical to what was done in Prop. 5.2.6: a sequence z_k with $|\nabla \tilde{v}_k(z_k)| \rightarrow \infty$ gives rise to a non-constant finite energy plane or disk. A disk is impossible for the same reasons as before: its boundary would have to be contractible on L , leading to the conclusion that the map is constant. A plane cannot be asymptotic to any cover of P_∞ or any orbit that is linked with it. The only new feature is that *a priori* the plane could be asymptotic to one of the orbits on L , but this would imply that v_k intersects K for large k , and is thus also excluded.

Suppose P_∞ has period T and the orbits of X_{λ_∞} on L have period T' . Then using Stokes' theorem and the fact that $d\lambda_k$ vanishes on TL ,

$$\mathcal{A}_{\lambda_k}(\tilde{v}_k) = \int_{[0, \infty) \times S^1} v_k^* d\lambda_k = T - \int_{\{0\} \times S^1} v_k^* \lambda_k \rightarrow T - (-T') = T + T'$$

as $k \rightarrow \infty$. Here we've used the fact that $v_k(\{0\} \times S^1)$ is homotopic to the periodic orbits on L , with reversed orientation. Then for sufficiently large k there is a sequence $s_k \in (0, \infty)$ such that

$$\int_{[0, s_k] \times S^1} v_k^* d\lambda_k = \frac{T'}{2}.$$

We claim that $s_k \rightarrow \infty$. Otherwise, there is a subsequence for which $s_k \rightarrow s_\infty \in [0, \infty)$ and (in light of the gradient bound), there are real numbers c_k such that $(b_k + c_k, v_k)$ is C_{loc}^∞ -convergent to a \tilde{J}_∞ -holomorphic half-cylinder

$$\tilde{v} = (b, v) : [0, \infty) \times S^1 \rightarrow \mathbb{R} \times S^3$$

with finite energy. Then

$$\begin{aligned} \mathcal{A}_{\lambda_\infty}(\tilde{v}) &= \int_{[0, \infty) \times S^1} v^* d\lambda_\infty \geq \int_{[0, s_\infty] \times S^1} v^* d\lambda_\infty = \lim_k \int_{[0, s_k] \times S^1} v_k^* d\lambda_k \\ &= \frac{T'}{2} > 0, \end{aligned}$$

and thus $\pi T v$ is not identically zero. From this and the wind_π estimate of Theorem 4.3.7, we deduce $\text{wind}_\pi(\tilde{v}) = 0$, so $v : [0, \infty) \times S^1 \rightarrow S^3$ is everywhere transverse to X_{λ_∞} . But this is impossible at the boundary, since both $v(\{0\} \times S^1)$ and the Reeb orbits on L are meridians. This proves the claim.

Now define a new sequence

$$\tilde{w}_k = (\beta_k, w_k) : [-s_k, \infty) \times S^1 \rightarrow \mathbb{R} \times S^3$$

by $\tilde{w}_k(s, t) = \tilde{v}_k(s + s_k, t)$. Then a subsequence of $(\beta_k + c_k, w_k)$ converges in $C_{\text{loc}}^\infty(\mathbb{R} \times S^1, \mathbb{R} \times S^3)$ to a \tilde{J}_∞ -holomorphic finite energy cylinder

$$\tilde{w}_\infty = (\beta_\infty, w_\infty) : \mathbb{R} \times S^1 \rightarrow \mathbb{R} \times S^3.$$

It cannot be a constant map, since

$$\begin{aligned} \int_{\{0\} \times S^1} w_\infty^* \lambda_\infty &= \lim_k \int_{\{0\} \times S^1} w_k^* \lambda_k = \lim_k \int_{\{s_k\} \times S^1} v_k^* \lambda_k \\ &= \lim_k \int_{\{0\} \times S^1} v_k^* \lambda_k + \lim_k \int_{[0, s_k] \times S^1} v_k^* d\lambda_k \\ &= -T' + \frac{T'}{2} = -\frac{T'}{2} < 0. \end{aligned} \quad (5.3.1)$$

Since there are no non-constant holomorphic spheres, at least one of the punctures must be nonremovable; we claim that they both are. Otherwise, we could define a smooth map of a disk into $S^3 \setminus K$ sending the boundary to P_∞ , implying the contradiction $\text{lk}(P_\infty, K) = 0$. Denote $w_\infty(\{\pm\infty\} \times S^1) = P_\pm$. Then there are real numbers s_- near $-\infty$ and s_+ near $+\infty$ such that for some large k , $v_k(\{s_k + s_\pm\} \times S^1)$ is close to P_\pm , and since $v_k(\{s\} \times S^1) \rightarrow P_\infty$ as $s \rightarrow \infty$,

$$\text{lk}(P_\pm, K) = \text{lk}(P_\infty, K).$$

If P_\pm is geometrically distinct from P_∞ , then we have also

$$\text{lk}(P_\pm, P_\infty) = 0,$$

since $v_k : [0, \infty) \times S^1 \rightarrow S^3 \setminus P_\infty$ can be glued along $\{0\} \times S^1$ to a disk contained in N . These two relations imply that each orbit P_\pm either is P_∞ or is contained in L , simply covered in either case. We can determine the sign of each puncture by comparing the orientations of $w_\infty(\{\pm\infty\} \times S^1)$ with the orientations of the orbits. There are four possibilities:

- (i) $P_+ = P_\infty$ (positive puncture) and $P_- = P_\infty$ (negative puncture)
- (ii) $P_+ \subset L$ (negative puncture) and $P_- \subset L$ (positive puncture)
- (iii) $P_+ = P_\infty$ (positive puncture) and $P_- \subset L$ (positive puncture)
- (iv) $P_+ \subset L$ (negative puncture) and $P_- = P_\infty$ (negative puncture)

Case (iv) is immediately excluded because both punctures can't be negative. In cases (i) and (ii), $\mathcal{A}_{\lambda_\infty}(\tilde{w}_\infty) = 0$, so $w_\infty^* d\lambda_\infty \equiv 0$ and we use Stokes' theorem to compute

$$\int_{\{0\} \times S^1} w_\infty^* \lambda_\infty = \lim_{s \rightarrow \infty} \int_{\{s\} \times S^1} w_\infty^* \lambda_\infty = T \text{ or } -T',$$

contradicting (5.3.1). We conclude that both punctures are positive, with $P_+ = P_\infty$ and $P_- \subset L$.

To apply this result to the sequence \tilde{u}_k , define a sequence of diffeomorphisms

$$\varphi_k : \mathbb{C} \setminus \{0\} \rightarrow \mathbb{C} \setminus \mathcal{D}$$

such that $\varphi_k(z) = e^{2\pi s_k} z$ for all $z \in \mathbb{C} \setminus \{0\}$ with $|z| \geq 2e^{-2\pi s_k}$. Then observe that $\tilde{w}_k \circ \psi^{-1}(z) = \tilde{u}_k \circ \varphi_k(z)$ whenever $|z| \geq 2e^{-2\pi s_k}$, thus after \mathbb{R} -translation, a subsequence of $\tilde{u} \circ \varphi_k$ converges in $C_{\text{loc}}^\infty(\mathbb{C} \setminus \{0\}, \mathbb{R} \times S^3)$ to

$$\tilde{u}_\infty = \tilde{w}_\infty \circ \psi^{-1} : \mathbb{C} \setminus \{0\} \rightarrow \mathbb{R} \times S^3,$$

which is asymptotic to P_∞ at ∞ and an orbit on L at 0. Clearly also $\varphi_k^* i \rightarrow i$ in $C_{\text{loc}}^\infty(S^2 \setminus \{0\})$. We have thus proved Theorem 5.3.1 for the case $\chi(\dot{\Sigma}) \geq 0$.

Proof in the stable case

Now assume $\chi(\dot{\Sigma}) < 0$. To prove the theorem in this case, we'll follow roughly the same sequence of steps as in Theorem 5.2.2, with a few important differences.

Step 1: Gradient bounds

We begin by establishing a bound

$$|d\tilde{u}_k(z)|_k \leq \frac{C}{\text{inrad}_{h_k}(z)},$$

where h_k is the Poincaré metric for $(\dot{\Sigma}, j_k)$ and the norm is defined in terms of this metric and an \mathbb{R} -invariant metric \tilde{g} on $\mathbb{R} \times S^3$ (see Sec. 5.2.1). The proof is mostly the same as in Prop. 5.2.3. If a finite energy plane bubbles off, then it is asymptotic to an orbit P which (for topological reasons) cannot be a cover of P_∞ , and $\text{lk}(P, P_\infty) = 0$. The only remaining alternative (which is new in this situation) is that P is a meridian on one of the tori L_j , but this would imply $\text{lk}(P, K_j) \neq 0$, so $u_k(\dot{\Sigma})$ would have to intersect K_j for some large k .

If a disk bubbles off, then the usual linking arguments show that its boundary is contractible on L_j , leading to a contradiction.

To prepare for the next step, we note that a subsequence of $(\Sigma, j_k, \{\infty\})$ converges (in the sense of Appendix B) to a stable nodal surface $\mathbf{S} = (S, j, \{p\}, \Delta, N)$. Thus there is a decoration r and a sequence of diffeomorphisms $\varphi_k : \overline{\mathbf{S}}_r \rightarrow \Sigma$ such that $\varphi_k^* j_k \rightarrow j_{\mathbf{S}}$ in $C_{\text{loc}}^\infty(\overline{\mathbf{S}}_r \setminus \Theta_{\Delta, N})$, where $j_{\mathbf{S}}$ is the singular conformal structure defined on $\overline{\mathbf{S}}_r$ by j and the natural inclusion

$$S \setminus (\Delta \cup N) \hookrightarrow \overline{\mathbf{S}}_r.$$

As before we label connected components by $S = S_1 \cup \dots \cup S_n$ and $\dot{S} = \dot{S}_1 \cup \dots \cup \dot{S}_n$, choosing the labels so that $p \in S_1$. Then each \dot{S}_j is naturally included in \overline{S}_r , and $\varphi_k^* j_k \rightarrow j$ in $C_{\text{loc}}^\infty(\dot{S}_j)$. The gradient bound above then implies that we can find constants $c_k^j \in \mathbb{R}$ such that

$$(a_k + c_k^j, u_k) \circ \varphi_k|_{\dot{S}_j} \rightarrow \tilde{v}^j : \dot{S}_j \rightarrow \mathbb{R} \times S^3$$

in $C_{\text{loc}}^\infty(\dot{S}_j, \mathbb{R} \times S^3)$, where $T\tilde{v}^j \circ j = \tilde{J} \circ T\tilde{v}^j$. Our main goal will be to show that \mathbf{S} has no double points and no boundary, but does have m unpaired nodes, one corresponding to each component of $\partial\Sigma$.

Step 2: Asymptotic behavior at p

The same arguments as in Prop. 5.2.7 show that p is a nonremovable puncture for $\tilde{v}^1 : \dot{S}_1 \rightarrow \mathbb{R} \times S^3$, and if P is an asymptotic limit then either $P = P_\infty$ (simply covered) or P is geometrically distinct from P_∞ , with $\text{lk}(P, P_\infty) = 0$. In the present context this last possibility implies that P is an n -fold cover of an orbit P_1 on one of the tori L_i , with $\text{lk}(P, K_i) = n \cdot \text{lk}(P_1, K_i) = -n$. (As always, $n \neq 0$ and is negative if the puncture is negative.) Then we can choose a small circle C about p such that $u_k(\varphi_k(C))$ is close to P for some large k , and thus construct a homotopy from P to P_∞ through $S^3 \setminus K$, implying

$$\text{lk}(P, K_j) = \text{lk}(P_\infty, K_j) > 0$$

for each component $K_j \subset K$. The left hand side is 0 if $K_j \neq K_i$, so this alternative can only happen if K is connected: in that case $-n = \text{lk}(P_\infty, K) = m$, so p is a negative puncture and P is an m -fold cover of P_1 . We shall use arguments similar to the proof of the non-stable case to show that this is also impossible.

Identify a punctured neighborhood of p in \dot{S}_1 with the positive half-cylinder via a holomorphic embedding

$$\psi : [0, \infty) \times S^1 \hookrightarrow S_1 \setminus \{p\},$$

and define $\tilde{w}_k = (\beta_k, w_k) = \tilde{u}_k \circ \varphi_k \circ \psi : [0, \infty) \times S^1 \rightarrow \mathbb{R} \times S^3$. Due to the asymptotic behavior of \tilde{v}^1 , there exists a sequence $s_k \rightarrow \infty$ such that $w_k(s_k, t)$ converges in $C^\infty(S^1, S^3)$ to $x(-mt)$ where $x : \mathbb{R} \rightarrow S^3$ is the periodic orbit P_1 with period $T_1 > 0$. Let $A_k \subset \dot{\Sigma}$ be the compact subset bounded by $\varphi_k \circ \psi(\{s_k\} \times S^1)$. Then as $k \rightarrow \infty$, Stokes' theorem implies

$$\int_{A_k} u_k^* d\lambda_k = \int_{\{s_k\} \times S^1} w_k^* \lambda_k + \int_{\partial\Sigma} u_k^* d\lambda_k \rightarrow -mT_1 - \sum_{\gamma_j \subset \partial\Sigma} T_1 = 0. \quad (5.3.2)$$

On the other hand, a similar calculation shows

$$\int_{\dot{\Sigma}} u_k^* d\lambda_k = T + \int_{\partial\Sigma} u_k^* d\lambda_k \rightarrow T + mT_1 > 0, \quad (5.3.3)$$

where T is the period of P_∞ . This indicates that all contact area is being absorbed toward the puncture as $k \rightarrow \infty$, so another holomorphic curve is bubbling off. To see this, choose $s'_k > s_k$ so that if $A'_k \subset \dot{\Sigma}$ is the compact subset bounded by $\varphi_k \circ \psi(\{s'_k\} \times S^1)$ then

$$\int_{A'_k} u_k^* d\lambda_k = \frac{T_1}{2},$$

which is possible due to (5.3.2) and (5.3.3). Now let $F_k : [-s'_k, \infty) \times S^1 \rightarrow [0, \infty) \times S^1$ be the translations $F_k(s, t) = (s + s'_k, t)$ and define a new sequence

$$\tilde{w}'_k = (\beta'_k, w'_k) = \tilde{w}_k \circ F_k : [-s'_k, \infty) \times S^1 \rightarrow \mathbb{R} \times S^3.$$

Since $\varphi_k^* j_k \rightarrow j$ in C^∞ on any compact neighborhood of p , we have $(\varphi_k \circ \psi)^* j_k \rightarrow i$ in $C^\infty([0, \infty) \times S^1)$ (not just on compact subsets); this follows from Lemma 5.3.2 below. Thus $F_k^*(\varphi_k \circ \psi)^* j_k \rightarrow i$ in $C_{\text{loc}}^\infty(\mathbb{R} \times S^1)$. By the usual linking arguments, there is a uniform bound for $|\nabla \tilde{w}_k|$, and thus also for $|\nabla \tilde{w}'_k|$. Then there are constants $c_k \in \mathbb{R}$ such that a subsequence of $(\beta'_k + c_k, w'_k)$ converges in $C_{\text{loc}}^\infty(\mathbb{R} \times S^1, \mathbb{R} \times S^3)$ to a \tilde{J}_∞ -holomorphic finite energy cylinder

$$\tilde{w} = (\beta, w) : \mathbb{R} \times S^1 \rightarrow \mathbb{R} \times S^3.$$

We compute

$$\begin{aligned} \int_{\{0\} \times S^1} w^* \lambda_\infty &= \lim_k \int_{\{0\} \times S^1} (w'_k)^* \lambda_k = \lim_k \int_{\{s'_k\} \times S^1} w_k^* \lambda_k \\ &= \lim_k \int_{A'_k} u_k^* d\lambda_k - \lim_k \int_{\partial\Sigma} u_k^* \lambda_k = \left(\frac{1}{2} - m\right) T_1 < 0, \end{aligned} \quad (5.3.4)$$

thus \tilde{w} is not constant. For the asymptotic limits, the same linking arguments as in the proof of the non-stable case give four alternatives, and we argue in the same way that $w(\mathbb{R} \times S^1)$ is not contained in either P_∞ or P_1 . Thus both punctures are positive, with asymptotic limits P_∞ at $s = \infty$ and an m -fold cover of P_1 at $s = -\infty$.

Recall now from Sec. 4.2.3 that there is a natural trivialization Ψ of ξ_∞ along $P_1 \subset L$ defined by the intersection $TL \cap \xi_\infty$. Since $\pi T w$ does not vanish identically, it's asymptotic behavior at $s = -\infty$ is described by a nonzero eigenfunction of the asymptotic operator. We claim that this eigenfunction has winding number 0

with respect to Ψ ; otherwise we could find s_0 near $-\infty$ such that for large k , the loop $u_k \circ \varphi_k \circ \psi(s_0, t)$ winds around P_1 , and must therefore intersect L , which is a contradiction. Then Theorem 4.2.14 implies that L is a positive Morse-Bott manifold, and by Prop. 4.2.12, $\mu_{\text{CZ}}^{\Psi, -}(P_1) = 1$. We also are given a trivialization Φ_∞ of $\xi_\infty|_M$, in which $\mu_{\text{CZ}}^{\Phi_\infty}(P_\infty) = 3$ and $\text{wind}_{P_1}^{\Phi_\infty}(\Psi) = -m$, thus $\mu_{\text{CZ}}^{\Phi_\infty, -}(P_1) = 1 - 2m$. So $\mu_{\text{CZ}}(\tilde{w}) = 3 + 1 - 2m = 4 - 2m$, and the wind_π estimate of Theorem 4.3.7 gives

$$\begin{aligned} 0 \leq 2 \text{wind}_\pi(\tilde{w}) &\leq \mu(\tilde{w}) - 2\chi(S^2) + 2(\#\Gamma_0) + \#\Gamma_1 \\ &= 4 - 2m - 4 + 2 = 2(1 - m). \end{aligned}$$

But we've assumed $m \geq 2$, so this is a contradiction.

We're left with the alternative that \tilde{v}^1 is positively asymptotic to P_∞ at the marked point p .

Before moving on, we should note the following lemma, which was used in the argument above to prove C^∞ -convergence on the noncompact set $[0, \infty) \times S^1$.

Lemma 5.3.2. *Let $A_k : \mathbb{D} \rightarrow \text{End}(T\mathbb{D})$ be a sequence of smooth sections of the tensor bundle $\text{End}(T\mathbb{D}) \rightarrow \mathbb{D}$ such that $A_k \rightarrow 0$ in $C^\infty(\mathbb{D})$. Then if $\psi : [0, \infty) \times S^1 \rightarrow \mathbb{D} \setminus \{0\}$ is the biholomorphic map $\psi(s, t) = e^{-2\pi(s+it)}$, the tensors $\psi^* A_k$ on $[0, \infty) \times S^1$ converge uniformly to 0 with all derivatives.*

Proof. Define the Euclidean metric on both \mathbb{D} and $[0, \infty) \times S^1$, and use the natural coordinates on each to write sections of $\text{End}(T\mathbb{D})$ or $\text{End}(T([0, \infty) \times S^1))$ as smooth real 2-by-2 matrix valued functions. If $\psi(s, t) = z$, then the first derivative of ψ at (s, t) and its inverse can be written as

$$\begin{aligned} D\psi(s, t) &= -2\pi e^{-2\pi(s+it)} = -2\pi z, \\ D\psi^{-1}(z) &= -\frac{1}{2\pi z} = -\frac{1}{2\pi} e^{2\pi(s+it)}, \end{aligned} \tag{5.3.5}$$

using the natural inclusion of \mathbb{C} in the space of real 2-by-2 matrices. Then

$$(\psi^* A_k)(s, t) = D\psi^{-1}(z) \circ A_k(z) \circ D\psi(s, t) = e^{2\pi it} A_k(z) e^{-2\pi it},$$

so $\|\psi^* A_k\|_{C^0} = \|A_k\|_{C^0} \rightarrow 0$ since the matrices on either side of $A_k(z)$ are orthogonal. We obtain convergence for all derivatives by observing that for any multiindex α , $\partial^\alpha(\psi^* A_k)(s, t)$ is a finite sum of expressions of the form

$$c \cdot U \cdot e^{2\pi it} \cdot D^j A_k(z)(z, \dots, z) \cdot e^{-2\pi it} \cdot V$$

where c is a real constant, U and V are constant unitary matrices (i.e. complex numbers of modulus 1), and $j \leq |\alpha|$. This is clearly true for $|\alpha| = 0$ and follows easily for all α by induction, using (5.3.5). The norm of this expression clearly goes to 0 uniformly in (s, t) as $k \rightarrow \infty$. \square

Step 3: Degeneration of j_k

Most of the hard work for this step was done in the proof of Prop. 5.2.7; in particular, the discussion surrounding Figures 5.6 and 5.7 applies in the present situation as well.⁴ The main difference here is that, since there are now orbits that are unlinked with P_∞ , it is not so trivial to exclude interior double points. Unpaired nodes, of course, will not be excluded at all; they will *replace* the boundary.

Claim: $\Delta \cap S_1$ is empty. This will follow from similar algebraic relations to the ones that were previously used only to exclude boundary double points. At any component $\alpha_j \subset \partial S_1$, the homotopy class of $v^1(\alpha_j)$ in $L_{f(j)}$ is fully determined by (5.2.12), giving the Maslov index $-2\widehat{m}_j$ with respect to the given trivialization Φ_∞ of $\xi_\infty|_M$.

The behavior at an unpaired node $w_j \in N \cap S_1$ is similarly constrained: by (5.2.14), the asymptotic limit P_j can only be one of the Morse-Bott orbits on some torus L_i . Then (5.2.13) tells us the torus in question must be $L_{g(j)}$, and since $\text{lk}(P_j, K_{g(j)}) = -1$, the covering number $n_j = 1$. So w_j is a positive puncture, and repeating the argument from Step 2, the asymptotic approach to P_j is described by an eigenfunction with zero winding relative to the natural framing determined by $TL_{g(j)} \cap \xi_\infty$. Prop. 4.2.12 and Theorem 4.2.14 then give Conley-Zehnder index 1 with respect to this framing. The framing itself has winding number -1 along P_j with respect to the trivialization Φ_∞ , which changes the Conley-Zehnder index to $-2 + 1 = -1$.

Likewise at an interior double point $z_j \in \Delta \cap \text{int } S_1$, the asymptotic limit P'_j must belong to a Morse-Bott torus, and summing (5.2.15) over all components $K_i \subset K$ we have

$$-n'_j = n'_j \text{lk}(P'_j, K) = \text{lk}(u_k(\partial_j \Sigma), K) = -m_j,$$

so z_j is a positive puncture with covering number m_j . The Conley-Zehnder index with respect to the natural framing on the torus is again 1, but now the framing winds $-m_j$ times with respect to Φ_∞ , giving index $-2m_j + 1$.

We now compute the generalized Maslov index

$$\mu(\tilde{v}^1) = 3 + \ell(-1) + \sum_{j=1}^q (1 - 2m_j) - 2 \sum_{j=1}^s \widehat{m}_j = 3 - \ell + q - 2 \left(\sum_{j=1}^q m_j + \sum_{j=1}^s \widehat{m}_j \right).$$

We can assume that at least one of the sets ∂S_1 , $N \cap S_1$ and $\Delta \cap \text{int } S_1$ is nonempty, in which case v^1 approaches one of the tori L_i *somewhere*, while approaching P_∞ at the marked point p . It follows that the image of v^1 is not contained in any single

⁴As in the proof of Prop. 5.2.7, the original version of this argument contained a gap that has been fixed in the revision.

periodic orbit, so \tilde{v}^1 has nonvanishing contact area and $\pi T v^1$ is not identically zero. Thus Theorem 4.3.7 gives

$$\begin{aligned}
0 \leq 2 \operatorname{wind}_\pi(\tilde{v}^1) &\leq \mu(\tilde{v}^1) - 2\chi(S_1) + 2(\#\Gamma_0) + \#\Gamma_1 \\
&= 3 - \ell + q - 2 \left(\sum_{j=1}^q m_j + \sum_{j=1}^s \widehat{m}_j \right) - 2(2 - s) + 1 + \ell + q \\
&= 2 \left(\sum_{j=1}^q (1 - m_j) + \sum_{j=1}^s (1 - \widehat{m}_j) \right). \quad (5.3.6)
\end{aligned}$$

Recalling that always $m_j \geq 2$ and $\widehat{m}_j \geq 1$, we conclude $q = 0$ and $\widehat{m}_j = 1$ for each j , so $\Delta \cap \operatorname{int} S_1$ is empty, and by the same argument as in the proof of Theorem 5.2.2, so is $\Delta \cap \partial S_1$.

Claim: $\partial S_1 = \emptyset$ and $\#N = m$. We've now established that S can have only one connected component (there are no double points to connect S_1 with anything else), thus $\overline{S}_r = \overline{S}_1 \cong \Sigma$, and $m = s + \ell$. We need to prove $s = 0$. Having just shown that everything on the right hand side of (5.3.6) vanishes, we have $\operatorname{wind}_\pi(\tilde{v}^1) = 0$, so $v : \dot{S}_1 \rightarrow S^3$ is immersed and transverse to X_{λ_∞} . But if $\partial S_1 \neq \emptyset$ this cannot be true, because $v^1(\partial S_1)$ and all orbits of X_{λ_∞} on L_j are meridians.

By the above results, S is a sphere with one marked point p and unpaired nodes $N = \{w_1, \dots, w_m\} \subset S \setminus \{p\}$, so we can identify it holomorphically with the Riemann sphere (S^2, i) , setting $\infty := p$ and $\Gamma' := N$. The diffeomorphisms $\varphi_k : \overline{S}_r \rightarrow \Sigma$ preserve ∞ , and restricting them to the interior they define diffeomorphisms

$$\varphi_k : S \setminus \Gamma' \rightarrow \operatorname{int} \Sigma,$$

with $\varphi_k^* j_k \rightarrow i$ in $C_{\operatorname{loc}}^\infty(S \setminus \Gamma')$. Moreover, after \mathbb{R} -translation, $\tilde{u}_k \circ \varphi_k \rightarrow \tilde{v}^1$ in $C_{\operatorname{loc}}^\infty(S \setminus (\{\infty\} \cup \Gamma'), \mathbb{R} \times S^3)$, and \tilde{v}^1 has precisely the required asymptotic behavior at the punctures ∞ and $w_j \in \Gamma'$. This concludes the proof of Theorem 5.3.1.

Chapter 6

Sketch of a Floer-Type Theory for Foliations

6.1 Algebraization

In this chapter we resume discussion of the homotopy theory of finite energy foliations that was mentioned in the introduction. Since most of this theory is yet to be developed, the discussion will be of a speculative nature: conjectures and plausibility arguments take the place of theorems and proofs, and some of the definitions may be deliberately vague. The intention is merely to sketch an intuitive picture of what such a theory should look like, as motivation for future study. We can make use of some of the foliations that were constructed in previous chapters to provide concrete examples and motivate conjectures.

It was suggested by Hofer in [H00] that the theory of finite energy foliations and its connection to symplectic field theory might yield powerful tools for the study of three-manifolds. One potential starting point for this idea is to define SFT-type algebraic objects that encode the data of a foliation. It's clear from looking at any of the pictures of stable foliations in Chapters 1 and 3 that such an "algebraization" should be possible: the degeneration of index 2 families to broken index 1 leaves in these pictures is precisely the kind of behavior that makes theories such as Floer homology possible. We will now set about defining a simple version of such a theory.

Let (M, λ) be a closed contact 3-manifold with an admissible complex multiplication $J : \xi \rightarrow \xi$, admitting a stable spherical finite energy foliation \mathcal{F} . We denote by $\mathcal{P}_{\mathcal{F}} \subset M$ the union of all asymptotic orbits occurring in \mathcal{F} . It will be convenient for the purposes of this sketch to make the following simplifying assumptions:

1. All asymptotic orbits for leaves of \mathcal{F} are simply covered.

2. For each leaf $\tilde{u} \in \mathcal{F}$, different punctures always have different asymptotic limits.
3. $H_1(M)$ is torsion free.

Note that all of the Morse-Bott foliations we've constructed have the first two properties, and one can assume without loss of generality that their nondegenerate perturbations do as well. (In some cases it may require increasing the number of orbits on each perturbed Morse-Bott torus in order to ensure that distinct punctures go to distinct orbits.)

In general contact topology, the Floer-type invariants constructed from moduli spaces of punctured holomorphic spheres in symplectizations fall under the heading of *rational symplectic field theory* (see [EGH00]). The idea is to define a homology theory which encodes the degeneration of index 2 punctured holomorphic spheres as a graded Poisson superalgebra $H_*^{\text{RSFT}}(M, \lambda, J)$. Since the theory of foliations discussed here deals exclusively with leaves of genus 0, it seems natural to define an analogous algebra $H_*^{\text{RSFT}}(\mathcal{F})$ using only the components of the moduli space that are present in the foliation.

Following [EGH00], we must first make some choices in order to define the grading. Using the assumption that $H_1(M)$ has no torsion, we choose a finite set of embedded oriented circles $C_j \subset M$ that generate a basis of $H_1(M)$, and for each orbit $\gamma \in \mathcal{P}_{\mathcal{F}}$, choose a surface $F_\gamma \subset M$ representing a singular chain $[F_\gamma]$ such that

$$\partial[F_\gamma] = [\gamma] - \sum_j n_j [C_j]$$

for a unique set of integers $n_j \in \mathbb{Z}$. For any leaf $\tilde{u} \in \mathcal{F}$, one can then piece together the chain $[\tilde{u}]$ with the chains $[F_\gamma]$ for each of its asymptotic limits, forming a homology cycle, also denoted by $[\tilde{u}] \in H_2(M)$. Choose trivializations of ξ along the circles C_j and extend them over the surfaces F_γ . This gives trivializations of ξ along each nondegenerate orbit γ , with which we can define Conley-Zehnder indices $\mu_{\text{CZ}}(\gamma)$. We will consider an algebra generated by objects q_γ and p_γ associated with each orbit $\gamma \in \mathcal{P}_{\mathcal{F}}$. These are assigned integer degrees

$$|q_\gamma| = \mu_{\text{CZ}}(\gamma) - 1, \quad |p_\gamma| = -\mu_{\text{CZ}}(\gamma) - 1.$$

Each orbit thus inherits a parity $|\gamma| \in \mathbb{Z}_2$, which doesn't depend on any choices; note that it is the *opposite* of the even/odd parity defined by $\mu_{\text{CZ}}(\gamma)$. The integer grading depends somewhat on the choices of C_j and F_γ . One can show however that the *relative* grading for homologous orbits is well defined, and for the case $[\gamma] = 0 \in H_1(M)$ the grading is absolute. Indeed, $|q_\gamma|$ can then be interpreted as the Fredholm

index of any finite energy plane \tilde{u} asymptotic to γ with $[\tilde{u}] = 0 \in H_2(M)$. (One needn't assume that such a thing exists—the index can be calculated regardless!)

Denote by $\mathbb{Q}[H_2(M)]$ the *group algebra* of $H_2(M)$ with rational coefficients: this is the rational vector space with generators of the form t^A for $A \in H_2(M)$, where we assume t^A and t^B are linearly independent if $A \neq B$, and there is a multiplication law of the form $t^A t^B = t^{A+B}$. We define on $\mathbb{Q}[H_2(M)]$ the integer grading

$$|t^A| = -2\langle c_1(\xi), A \rangle.$$

Now let \mathfrak{P} be the free \mathbb{Z} -graded commutative superalgebra with unit, generated by p_γ and q_γ for all $\gamma \in \mathcal{P}_{\mathcal{F}}$, with coefficients in $\mathbb{Q}[H_2(M)]$. The prefix “super-” refers here to the convention that any two elements of odd degree anticommute, whereas they commute if one of the elements is even. We think of \mathfrak{P} informally as a space of functions on a symplectic supermanifold (the “phase space” with coordinates (q_γ, p_γ)), and as such there is a super-Poisson bracket defined by

$$\{F, G\} = \sum_{\gamma} (-1)^{(|F|+1)|\gamma|} \left(\frac{\partial F}{\partial p_\gamma} \frac{\partial G}{\partial q_\gamma} - (-1)^{|\gamma|} \frac{\partial F}{\partial q_\gamma} \frac{\partial G}{\partial p_\gamma} \right)$$

for $F, G \in \mathfrak{P}$. This is not the place to discuss signs in any detail, except to mention that one must take care in defining the partial derivatives with respect to odd variables. For a coherent approach to such matters, the recent book by Varadarajan [V04] is recommended.

The foliation \mathcal{F} defines a “Hamiltonian function” $\mathbf{h} \in \mathfrak{P}$ as follows. Associate with every rigid surface $\tilde{u} \in \mathcal{F}$ the monomial

$$q_{P_1^-} \cdots q_{P_r^-} p_{P_1^+} \cdots p_{P_s^+} t^A$$

where P_j^\pm are the positive/negative asymptotic limits of \tilde{u} and $A = [\tilde{u}] \in H_2(M)$. (Note: we're using the assumption that all orbits are simply covered. Otherwise this expression would need some rational factors, which is why we use \mathbb{Q} instead of \mathbb{Z} for coefficients.) We define \mathbf{h} to be the sum of these monomials for every rigid surface in \mathcal{F} , with appropriate signs corresponding to a choice of coherent orientations (cf. Sec. 1.8 of [EGH00], or [BoM03]). One can deduce from the Fredholm index formula that \mathbf{h} is a homogeneous element of odd degree. Observe that in this supersymmetric setting, Poisson brackets of two odd elements *commute*, so the following is not obvious:

Conjecture 6.1.1. $\{\mathbf{h}, \mathbf{h}\} = 0$.

As in the general version of RSFT, this should follow from a combination of compactness and gluing theorems: the idea is to interpret the expression $\{\mathbf{h}, \mathbf{h}\}$ as

an algebraic count of the components in the boundary of the moduli space of index 2 leaves in \mathcal{F} . For compactness, one must prove not only that index 2 families of leaves degenerate to broken index 1 curves, but also that both curves in such a limit are also leaves of the foliation. The gluing theorem would then say that any two rigid surfaces that connect at a single orbit can be glued into a family of index 2 curves which also belong to the foliation. Both results should follow from the intersection theory of finite energy surfaces.

One can now define a differential on \mathfrak{P} by $d^{\mathbf{h}}\mathbf{g} = \{\mathbf{h}, \mathbf{g}\}$, and it follows from the super-Jacobi identity that $(d^{\mathbf{h}})^2 = 0$. Thus we can define a \mathbb{Z} -graded homology algebra

$$H_*^{\text{RSFT}}(\mathcal{F}) = H_*(\mathfrak{P}, d^{\mathbf{h}}),$$

which inherits the Poisson bracket from \mathfrak{P} .

One nice thing about a foliation is that it gives a very concrete picture of the moduli space of rigid surfaces, which ought to make $H_*^{\text{RSFT}}(\mathcal{F})$ somewhat easier to compute than the analogous object in general SFT. That said, it's still hard. We therefore consider various simplified versions, such as a *contact homology* algebra $HC_*(\mathcal{F})$, and in some cases also *cylindrical contact homology* groups $HC_*^c(\mathcal{F})$.

The contact homology $HC_*(\mathcal{F})$ is defined by counting rigid surfaces that have only one positive puncture and an arbitrary number of negative punctures. We define $CC_*(\mathcal{F})$ to be the free commutative superalgebra over $\mathbb{Q}[H_2(M)]$ with unit, generated by the objects q_γ for $\gamma \subset \mathcal{P}_{\mathcal{F}}$. Then a differential $\partial : CC_*(\mathcal{F}) \rightarrow CC_*(\mathcal{F})$ of degree -1 is defined by

$$\partial q_\gamma = \sum n_\gamma^{A, \alpha_1, \dots, \alpha_s} q_{\alpha_1} \dots q_{\alpha_s} t^A$$

where $n_\gamma^{A, \alpha_1, \dots, \alpha_s}$ is an algebraic count (allowing for coherent orientations) of rigid surfaces $\tilde{u} \in \mathcal{F}$ with $[\tilde{u}] = A \in H_2(M)$, having a positive puncture at γ , negative punctures at $\alpha_1, \dots, \alpha_s$, and no other punctures. (Again, this formula would be more complicated if there were multiply covered orbits.) The sum includes the case with no negative punctures, for which the monomial $q_{\alpha_1} \dots q_{\alpha_s}$ becomes the unit element. Extending ∂ to the whole algebra by a supersymmetric Leibnitz rule, the same compactness and gluing results mentioned above should imply:

Conjecture 6.1.2. $\partial^2 = 0$.

The homology of the chain complex $(CC_*(\mathcal{F}), \partial)$ defines a *foliation contact homology* algebra $HC_*(\mathcal{F})$. As an abelian group, it splits into summands,

$$HC_*(\mathcal{F}) = \bigoplus_{h \in H_1(M)} HC_*(\mathcal{F}|_h),$$

where $HC_*(\mathcal{F}|_h)$ is the homology of the complex $CC^*(\mathcal{F}|_h)$ containing all monomials $q_{\alpha_1} \dots q_{\alpha_s}$ such that $[\alpha_1] + \dots + [\alpha_s] = h \in H_1(M)$. The summand $HC_*(\mathcal{F}|_0)$ is a subalgebra on which the integer grading is absolute; other summands are modules over $HC_*(\mathcal{F}|_0)$ with only a relative integer grading (it is absolute mod 2).

Cylindrical contact homology should be well defined if the foliation contains no rigid planes. Then for a given free homotopy class $h \in [S^1, M]$, we define $CC_*^c(\mathcal{F}|_h)$ to be the free module over $\mathbb{Q}[H_2(M)]$ generated by elements q_γ for $\gamma \subset \mathcal{P}_\mathcal{F}$ with $[\gamma] = h$. The differential $\partial : CC_*^c(\mathcal{F}|_h) \rightarrow CC_*^c(\mathcal{F}|_h)$ counts rigid cylinders in \mathcal{F} . One expects $\partial^2 = 0$ if there are no rigid planes, since this prevents families of index 2 cylinders from degenerating into anything other than broken cylinders.

6.2 Functoriality

In Sec. 1.5 we mentioned the notion of a *concordance* of foliations. The idea is essentially as follows: let (M, ξ) be a contact manifold with two contact forms λ_\pm such that $\lambda_+ = f\lambda_-$ for some smooth function $f > 1$, and pick two admissible complex multiplications $J_\pm : \xi \rightarrow \xi$. This data defines two almost complex structures \tilde{J}_\pm on $\mathbb{R} \times M$. Choose a number $a_0 > 0$ and a smooth nondecreasing family of functions f_a for $a \in \mathbb{R}$ which equals 1 for $a \leq -a_0$ and f for $f \geq a_0$, and define a smooth family of contact forms $\lambda_a = f_a\lambda_-$, interpolating between λ_- and λ_+ . Then we can find an almost complex structure \hat{J} which is tamed by some symplectic form $d(\varphi\lambda_a)$, matches \tilde{J}_- on $(-\infty, -a_0) \times M$ and matches \tilde{J}_+ on $[a_0, \infty) \times M$. This defines an almost complex manifold $(\mathbb{R} \times M, \hat{J})$ with cylindrical ends, interpolating between the data (λ_-, J_-) and (λ_+, J_+) .

Assume now that there is a 2-dimensional foliation \mathcal{F} of $\mathbb{R} \times M$ by embedded \hat{J} -holomorphic punctured spheres with finite energy. Each leaf is asymptotically cylindrical, with positive/negative punctures asymptotic to periodic orbits of X_{λ_\pm} . For $\sigma \in \mathbb{R}$, define translation maps

$$\psi_\sigma : \mathbb{R} \times M \rightarrow \mathbb{R} \times M : (a, m) \mapsto (a + \sigma, m),$$

then $\psi_\sigma^* \hat{J} \rightarrow \tilde{J}_\pm$ as $\sigma \rightarrow \pm\infty$. Thus for large $|\sigma|$, the foliations $\psi_\sigma^{-1}(\mathcal{F})$ consist of holomorphic curves with nearly \mathbb{R} -invariant almost complex structures, and one would expect to see approximately \mathbb{R} -invariant behavior in the foliations themselves. This leads to the notion of the *asymptotic foliations* \mathcal{F}^\pm , which we define informally by

$$\mathcal{F}^\pm = \lim_{\sigma \rightarrow \pm\infty} \psi_\sigma^{-1}(\mathcal{F}).$$

In practice, one might define this rigorously with a compactness argument to derive \tilde{J}_\pm -holomorphic index 2 curves through a dense set of points in $\mathbb{R} \times M$, then filling

in the rest by a second round of bubbling off analysis. (A similar technique was used in [HWZ03b] for stretching a singular holomorphic foliation of $\mathbb{C}P^2$ into a foliation of $\mathbb{R} \times S^3$.) One can see readily that if \mathcal{F} is a stable (\mathbb{R} -invariant) foliation, then $\mathcal{F}^\pm = \mathcal{F}$.

Given a stable foliation \mathcal{F} for (M, λ, J) and any constant $c > 0$, there is a corresponding stable foliation \mathcal{F}_c for $(M, c\lambda, J)$, defined by rescaling the leaves in the \mathbb{R} -direction. It will be convenient to call the foliations \mathcal{F} and \mathcal{F}_c equivalent, denoted $\mathcal{F} \cong \mathcal{F}_c$.

Definition 6.2.1. *Given stable foliations \mathcal{F}_0 and \mathcal{F}_1 for (M, λ_0, J_0) and (M, λ_1, J_1) respectively (with $\ker \lambda_0 = \ker \lambda_1$), a directed concordance from \mathcal{F}_0 to \mathcal{F}_1 is a foliation \mathcal{F}_{10} of an almost complex manifold with cylindrical ends such that*

$$\mathcal{F}_{10}^+ \cong \mathcal{F}_0, \quad \text{and} \quad \mathcal{F}_{10}^- \cong \mathcal{F}_1.$$

The word “directed” is important in this definition, since directed concordance defines a partial order rather than an equivalence relation. A directed concordance should determine a homomorphism $\Phi_{10} : HC_*(\mathcal{F}_0) \rightarrow HC_*(\mathcal{F}_1)$, defined by a chain map of degree 0 which counts index 0 leaves of the foliation \mathcal{F}_{10} . There should also be a gluing operation:

Conjecture 6.2.2. *Given two directed concordances \mathcal{F}_{10} and \mathcal{F}_{21} such that $\mathcal{F}_{10}^- \cong \mathcal{F}_{21}^+$, there is a directed concordance*

$$\mathcal{F}_{20} = \mathcal{F}_{21} \# \mathcal{F}_{10}$$

defined by gluing the leaves of the two foliations to form a new foliation, with $\mathcal{F}_{20}^+ \cong \mathcal{F}_{10}^+$ and $\mathcal{F}_{20}^- \cong \mathcal{F}_{21}^-$. Moreover, the corresponding homomorphisms on contact homology are related by $\Phi_{20} = \Phi_{21} \circ \Phi_{10}$.

The homomorphism Φ_{10} defined by \mathcal{F}_{10} should be invariant under a suitable definition of *homotopy* for \mathcal{F}_{10} . Loosely speaking, a homotopy \mathcal{F}_{10}^s is a continuous family of directed concordances from \mathcal{F}_0 to \mathcal{F}_1 . The technical definition is presumably quite complicated: we expect for instance that there should exist homotopies from honest foliations to singular foliations (in which neighboring leaves have isolated intersections), thus accommodating examples such as the circle bundle S^1TS , where stable foliations generically can’t exist (see Sec. 1.5). In any case, once this homotopy theory is placed on more solid ground, it should be possible to prove that

$$\Phi_{10} = \text{Id} \quad \text{whenever} \quad \mathcal{F}_0 \cong \mathcal{F}_1.$$

This would follow from a result that says if \mathcal{F} is a directed concordance with $\mathcal{F}_+ \cong \mathcal{F}_-$, then \mathcal{F} is homotopic to a trivial directed concordance in which all the index 0

leaves are orbit cylinders. A stable foliation is itself an example of such a trivial concordance, in the sense that

$$\mathcal{F}_{10} \# \mathcal{F}_0 \cong \mathcal{F}_{10} \quad \text{and} \quad \mathcal{F}_1 \# \mathcal{F}_{10} \cong \mathcal{F}_{10},$$

where in this context \cong means “homotopic”. With these notions in place, we can then define a nontrivial equivalence relation on the set of stable foliations:

Definition 6.2.3. *A concordance between \mathcal{F}_0 and \mathcal{F}_1 is a pair of directed concordances \mathcal{F}_{10} from \mathcal{F}_0 to \mathcal{F}_1 and \mathcal{F}_{01} from \mathcal{F}_1 to \mathcal{F}_0 . We then say that the foliations \mathcal{F}_0 and \mathcal{F}_1 are concordant.*

Conjecture 6.2.4. *The algebras $H_*^{RSFT}(\mathcal{F})$ and $HC_*(\mathcal{F})$ are invariant with respect to concordance.*

By the above remarks, the foliations \mathcal{F}_{01} and \mathcal{F}_{10} can sensibly be thought of as inverses of one another. Unlike the analogous situation of cylindrical symplectic cobordisms in SFT, it is not automatic that one can find an inverse for any given directed concordance. However, there is good reason to believe that the proposed program for constructing a concordance by homotopy should naturally construct its inverse as well. Recall, the claim was that given a foliation \mathcal{F}_0 for (M, λ_0, J_0) and another set of generic data (M, λ_1, J_1) with the same contact structure, there should be a foliation \mathcal{F}_1 for the new data along with a directed concordance \mathcal{F}_{10} from \mathcal{F}_0 to \mathcal{F}_1 . The idea is to begin with a trivial concordance from \mathcal{F}_0 to itself: more precisely, a holomorphic foliation of $(\mathbb{R} \times M, \hat{J})$ where \hat{J} interpolates between $\epsilon \lambda_0$ near $\{-\infty\} \times M$ and $\frac{1}{\epsilon} \lambda_0$ near $\{\infty\} \times M$. Then homotop this to a holomorphic foliation of $(\mathbb{R} \times M, \hat{J}_\sigma)$, where \hat{J}_σ is defined by (λ_1, J_1) in a large compact subset $[-\sigma, \sigma] \times M$. As we let $\sigma \rightarrow \infty$, this should split the foliation into two directed concordances \mathcal{F}_{10} and \mathcal{F}_{01} which are inverses. In the process we obtain the foliation \mathcal{F}_1 as an asymptotic foliation for each of \mathcal{F}_{10} and \mathcal{F}_{01} , and it follows that $HC_*(\mathcal{F}_1) = HC_*(\mathcal{F}_0)$.

For the cylindrical contact homology one must restrict the notion of a concordance before proving invariance. One way is by defining a *cylindrical concordance* to be a concordance in which none of the leaves of \mathcal{F}_{10} or \mathcal{F}_{01} are index 0 planes. This should permit the compactness result needed to prove that $HC_*^c(\mathcal{F})$ is invariant with respect to cylindrical concordance.

6.3 Computations of foliation contact homology

6.3.1 The tight 3-sphere

As a warm up, let us compute $HC_*(\mathcal{F}_1)$, where \mathcal{F}_1 is the stable foliation of the tight 3-sphere shown in Figure 6.1 (a product of the existence result in [HWZ03b]).

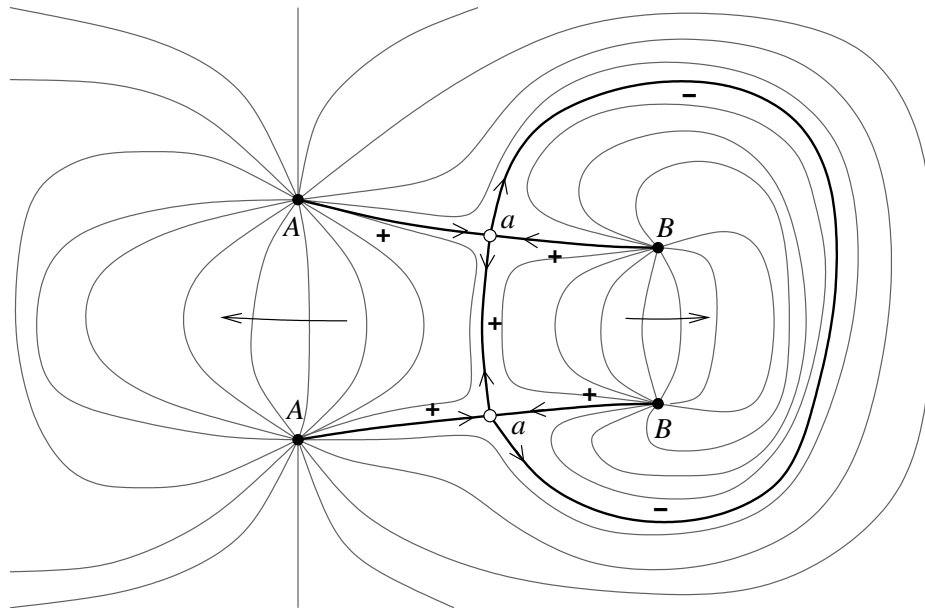

Figure 6.1: The foliation \mathcal{F}_1 of the tight 3-sphere, showing coherent orientations.

The figure shows a choice of coherent orientations for the moduli spaces of leaves, after dividing out the \mathbb{R} -action: for each rigid surface this is just a choice of sign, and orientations of index 2 families are shown with arrows. The choices are by no means unique, but they must follow a rule to ensure that gluing maps are orientation preserving. Thus at any “corner” of the diagram where there is a hyperbolic orbit, the arrow of an index 2 family points away from the corner if and only if the signs of the two neighboring rigid surfaces match. (Note that some of the rigid surfaces in this diagram are labeled more than once—e.g. the two positive segments on the left are part of the same rigid cylinder.)

To simplify the notation, we’ll write A , B and a instead of q_A , q_B and q_a . The capital letters represent elliptic orbits, with Conley-Zehnder index 3, and the hyperbolic orbit a has $\mu_{CZ}(a) = 2$. Thus the generators of $CC_*(\mathcal{F}_1)$ have degrees $|A| = |B| = 2$ and $|a| = 1$. There is one additional generator of degree 0: the unit element 1, which is a cycle by definition. Counting rigid surfaces, we find

$$\partial A = \partial B = a \quad \text{and} \quad \partial a = 1 - 1 = 0.$$

From this we compute $HC_0(\mathcal{F}_1) = \mathbb{Q}$, generated by the unit, and $HC_1(\mathcal{F}_1) = 0$. The generators of $CC_3(\mathcal{F}_1)$ are the products Aa and Ba ; then using the Leibnitz

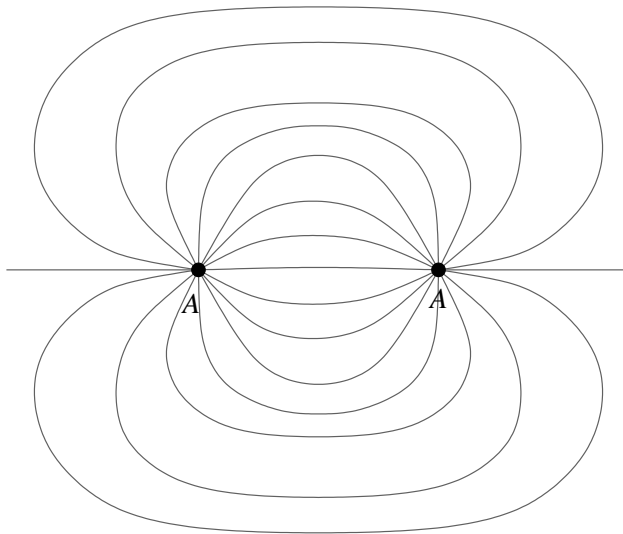

Figure 6.2: Foliation \mathcal{F}_0 , a planar open book decomposition of the tight 3-sphere.

rule and supercommutativity we have

$$\partial(Aa) = (\partial A)a = a^2 = 0 \quad \text{and} \quad \partial(Ba) = (\partial B)a = a^2 = 0.$$

Thus $HC_2(\mathcal{F}_1)$ is generated by $[A - B]$. To compute the rest of $HC_*(\mathcal{F}_1)$, we observe that everything in degree 3 and higher is generated by a product of A , B and a , so by considering symmetrized tensor products of $CC_1(\mathcal{F}_1)$ and $CC_2(\mathcal{F}_2)$, we find that $HC_{2k}(\mathcal{F}_1)$ is generated by $[(A - B)^k]$ and $HC_{2k+1}(\mathcal{F}_1) = 0$. Thus $HC_*(\mathcal{F}_1)$ is isomorphic to the rational cohomology ring of $\mathbb{C}P^\infty$.

We could have guessed this result by assuming that \mathcal{F}_1 is concordant with the open book decomposition \mathcal{F}_0 (Figure 6.2). $HC_*(\mathcal{F}_0)$ is trivial to compute since A is the only generator, with $|A| = 2$, hence $\partial = 0$ and $HC_{2k}(\mathcal{F}_0)$ is generated by $[A]$ for each $k \in \mathbb{N}$, while $HC_{2k+1}(\mathcal{F}_0) = 0$.

This result raises the question as to whether *all* of the foliations of (S^3, ξ_0) generated by the method in [HWZ03b] might be concordant. If so, one must wonder whether (S^3, ξ_0) admits any other foliations that are not concordant with these.

6.3.2 Overtwisted contact structures

Generally if (M, ξ) is a closed contact manifold and ξ is overtwisted, then its contact homology algebra $HC_*(M, \xi)$ is trivial. This follows by choosing the contact form so that it admits a hyperbolic orbit spanned by an index 1 plane; one can use this

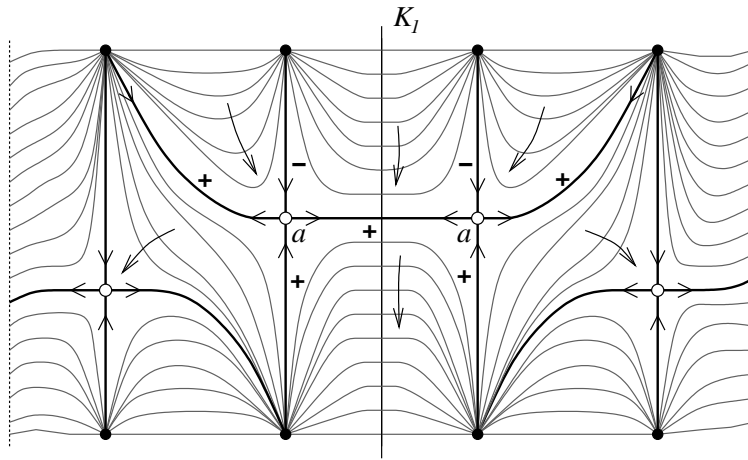

Figure 6.3: Cross section of a stable foliation in the neighborhood of a full-Lutz twist along the knot K_1

to show that the unit element is exact in the chain complex, so $[1] = 0$. A similar argument works in the context of foliations, although it is *not* true that $HC_*(\mathcal{F})$ always vanishes if \mathcal{F} lives in an overtwisted manifold. (We'll see an example for $S^1 \times S^2$ below.) What should be true is the following:

Conjecture 6.3.1. *For any overtwisted contact structure ξ on M , (M, ξ) admits a foliation \mathcal{F} such that $HC_*(\mathcal{F}) = 0$.*

We use the main result Theorem 1.3.3 to construct a foliation on (M, ξ) , with one extra detail: supplement the usual surgery along a link $K \subset S^3$ with an additional full-Lutz twist (see Chapter 2.1) along some separate knot $K_1 \subset S^3 \setminus K$. Recall that the full twist produces a 2-plane distribution that is homotopic to the original; then since ξ was already overtwisted, the new contact manifold is contactomorphic to (M, ξ) by Eliashberg's theorem. Carrying out the usual construction, we obtain a foliation which looks like Figure 6.3 near K_1 . In particular there is a rigid plane asymptotic to a hyperbolic orbit a , and this is the *only* rigid surface that has a as its unique positive limit. Thus $\partial a = 1$, and $HC_*(\mathcal{F})$ is trivial.

6.3.3 $S^1 \times S^2$

Choose the usual coordinates (θ, ρ, ϕ) on $S^1 \times \overline{B^2(0)}$ and collapse the boundary to a circle to define

$$S^1 \times S^2 = S^1 \times (\overline{B^2(0)}/\partial\overline{B^2(0)}).$$

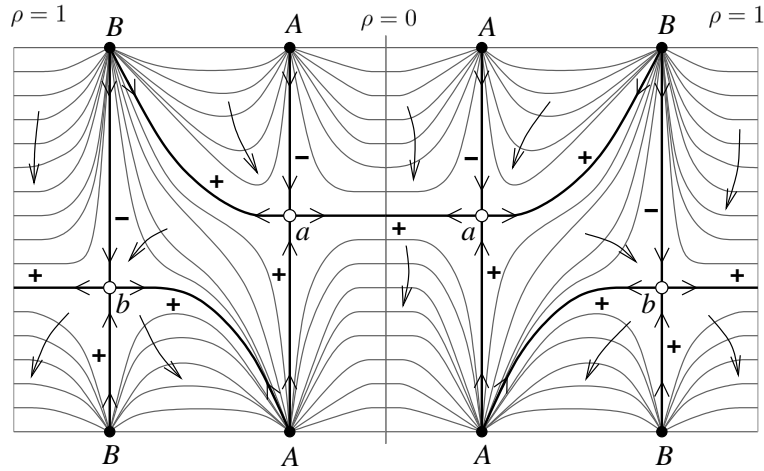

Figure 6.4: Foliation \mathcal{F}_2 on $S^1 \times S^2$

Define a contact form by $\lambda = f(\rho)d\theta + g(\rho)$ where the trajectory $\rho \mapsto (f(\rho), g(\rho)) \in \mathbb{R}^2$ winds once counterclockwise around the origin for $\rho \in [0, 1]$. The contact structure $\xi = \ker \lambda$ is overtwisted, and by the methods in Chapter 3 we can explicitly construct foliations of Morse-Bott type as well as nondegenerate perturbations.

One such example is the stable foliation \mathcal{F}_2 shown in Figure 6.4. This bears a strong resemblance to the full-Lutz twist, and $HC_*(\mathcal{F}_2)$ vanishes for the same reason.

Figure 6.5 shows two foliations that are quite different, for closely related nondegenerate perturbations of this same contact form λ . Unlike \mathcal{F}_2 , whose asymptotic orbits are all contractible, the asymptotic orbits here are all generators of $H_1(S^1 \times S^2) \cong \mathbb{Z}$. This suggests that there may be topological problems in constructing a concordance with \mathcal{F}_2 , and we can confirm this by calculating the contact homology.

We focus first on \mathcal{F}_3 . Since $H_1(S^1 \times S^2)$ and $H_2(S^1 \times S^2)$ are both nonzero, we must make some choices to set the grading. Note that A and C are homologous, as are B and b , which point in the opposite direction. Choose the oriented circle A as the canonical generator for $H_1(S^1 \times S^2)$. There are then obvious choices of cylinders F_B , F_b and F_C connecting each of the other orbits to A : pick the cylinders that project to vertical line segments in Figure 6.5 (left). With these choices, all of the rigid surfaces in the picture represent the trivial homology class in $H_2(S^1 \times S^2)$. The grading will be defined only up to an even integer offset, so we're free to pick a trivialization of ξ over A such that $\mu_{CZ}(A) = 1$. Then $\mu_{CZ}(B) = \mu_{CZ}(C) = 1$ and $\mu_{CZ}(b) = 0$, thus $CC_*(\mathcal{F}_3)$ has three generators of degree 0 and one of degree -1 .

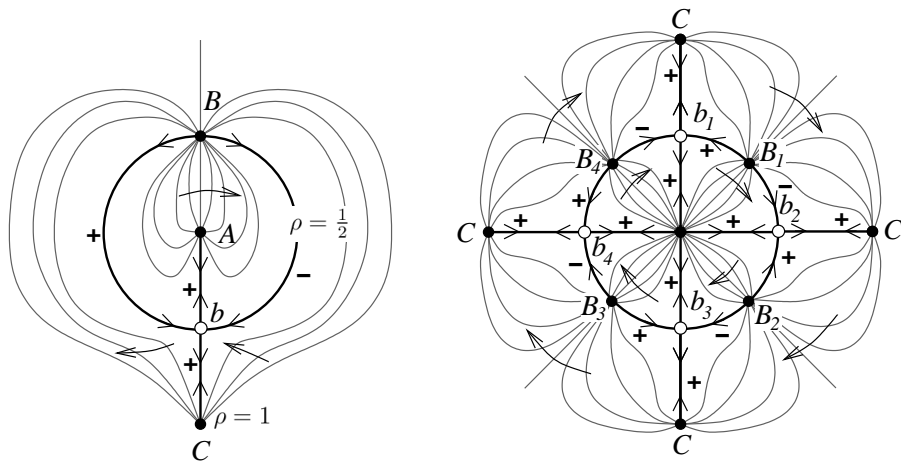

Figure 6.5: Foliation \mathcal{F}_3 (left) and \mathcal{F}_4 (right) on $S^1 \times S^2$

Counting rigid surfaces with one positive puncture, accounting for the coherent orientations, we find

$$\partial A = 0, \quad \partial C = 0, \quad \partial B = b - b = 0, \quad \text{and} \quad \partial b = 0.$$

Thus $HC_*(\mathcal{F}_3)$ is a free superalgebra with three even generators and one odd. In particular, both $HC_*(\mathcal{F}_3|_{[A]})$ and $HC_*(\mathcal{F}_3|_{-[A]})$ are nontrivial. $HC_*(\mathcal{F}_3|_0)$ is also nontrivial: it has generators $[AB]$ and $[CB]$ in degree 0, and $[Ab]$ and $[Cb]$ in degree -1 . Ignoring the technical details for now, this would seem to prove:

Conjecture 6.3.2. *The foliations \mathcal{F}_2 and \mathcal{F}_3 on $(S^1 \times S^2, \lambda)$ are not concordant.*

Another interesting question concerns the relationship between \mathcal{F}_3 and \mathcal{F}_4 , which are different nondegenerate perturbations of the same Morse-Bott foliation. Use A again as the canonical generator of $H_1(S^1 \times S^2)$, and choose F_{b_j} and F_{B_j} to be the cylinders that project to straight line segments connecting b_j or B_j to A in the picture, for $j = 1, \dots, 4$. Then once again all rigid surfaces in \mathcal{F}_4 are homologically trivial in $H_2(S^1 \times S^2)$. Picking a trivialization so that $\mu_{CZ}(A) = 1$, we have $\mu_{CZ}(C) = \mu_{CZ}(B_j) = 1$ and $\mu_{CZ}(b_j) = 0$ for all j . Then

$$\partial A = \partial C = \partial b_j = 0 \quad \text{and} \quad \partial B_j = b_j - b_{j+1},$$

using the convention $b_5 = b_1$. Thus the generators b_j are all homologous in $HC_{-1}(\mathcal{F}_4)$, and $\sum_j B_j$ is a cycle. It turns out that $HC_*(\mathcal{F}_4)$ is the free superalgebra generated by $[A]$, $[C]$ and $[\sum_j B_j]$ in degree 0 and $[b_1]$ in degree -1 . Thus $HC_*(\mathcal{F}_3) \cong HC_*(\mathcal{F}_4)$.

Clearly one obtains the same result for any similar perturbation with an arbitrary number of orbits b_j and B_j . The same phenomenon is observed in many other examples, which strongly suggests:

Conjecture 6.3.3. *$HC_*(\mathcal{F})$ is well defined if \mathcal{F} is a foliation of stable Morse-Bott type. In fact, any two nondegenerate perturbations of \mathcal{F} are concordant.*

This should follow from the construction of the nondegenerate perturbations, which would produce not only a stable foliation but also a concordance between this and the original Morse-Bott foliation.

Appendix A

Asymptotics of Finite Energy Surfaces

A.1 Asymptotic operators

In this appendix we present in precise form the results of Hofer, Wysocki and Zehnder from [HWZ96a] and [HWZ96b], which describe the asymptotic approach of finite energy surfaces to nondegenerate or Morse-Bott periodic orbits at the punctures. A complete understanding of this behavior requires us to consider certain self-adjoint operators of the form

$$\mathbf{A}_\infty = -J_0 \frac{d}{dt} - S_\infty(t),$$

where J_0 is a complex structure on \mathbb{R}^{2n} and $S_\infty(t)$ is a loop of symmetric matrices. Instead of presenting these operators out of the blue, it's worth taking a moment to see how they arise naturally in contact geometry. Such an operator appears also in the analysis of Floer homology (see for instance [S97]), where it can be interpreted as the Hessian of the symplectic action functional. We will see that a similar interpretation is available here.

Let (M, λ) be a contact manifold with contact structure $\xi = \ker \lambda$ and an admissible complex multiplication J on ξ . Let $S^1 = \mathbb{R}/\mathbb{Z}$ and define the *contact action functional*, $\Phi_\lambda : C^\infty(S^1, M) \rightarrow \mathbb{R}$ by

$$\Phi_\lambda(x) = \int_{S^1} x^* \lambda.$$

For this rather informal discussion, we will follow the standard practice of treating $C^\infty(S^1, M)$ as an infinite-dimensional smooth manifold with a well defined tangent bundle, and assume whenever convenient that differential geometry applies to this

manifold just as in the finite-dimensional case. The extent to which this is rigorously true will not concern us. That said, the tangent space at $x \in C^\infty(S^1, M)$ is

$$T_x C^\infty(S^1, M) = \Gamma(x^*TM),$$

the space of smooth sections of the bundle $x^*TM \rightarrow S^1$. Then we compute that the differential of Φ_λ at x is the linear map $d\Phi_\lambda(x) : \Gamma(x^*TM) \rightarrow \mathbb{R}$ defined by

$$d\Phi_\lambda(x)v = \int_{S^1} d\lambda(-\dot{x}(t), v(t)) dt.$$

Thus the critical points of Φ_λ are the *unparametrized* periodic orbits of the Reeb vector field, i.e. $x \in \text{Crit}(\Phi_\lambda)$ if and only if the image $x(S^1)$ is a closed Reeb orbit. Note that Φ_λ is invariant under the natural action of $\text{Diff}^+(S^1)$, the group of orientation preserving diffeomorphisms of S^1 ,

$$\text{Diff}^+(S^1) \times C^\infty(S^1, M) \rightarrow C^\infty(S^1, M) : (\varphi, x) \mapsto x \circ \varphi.$$

A critical point of Φ_λ is always degenerate due to the group action, and thus the ordinary Hessian carries redundant information. We therefore define a “restricted” Hessian, which is an isomorphism at any critical point that is “as nondegenerate as possible”. To see what this means, it’s instructive first to review the analogous situation in a finite-dimensional manifold.

The finite-dimensional case

Let M be a smooth finite-dimensional manifold with $f : M \rightarrow \mathbb{R}$ a smooth function. Assume there is also a Lie group G acting smoothly on M ,

$$G \times M \rightarrow M : (g, x) \mapsto \varphi_g(x),$$

with the following two properties:

- (i) $f \circ \varphi_g \equiv f$ for all $g \in G$.
- (ii) For all $x \in M$, the orbit $[x] = \{\varphi_g(x) \mid g \in G\}$ is a smooth submanifold of M , with fixed codimension.

Now on a neighborhood of $\text{Crit}(f)$, choose a smooth splitting $TM = \theta \oplus \eta$ such that for $x \in \text{Crit}(f)$, $\theta_x = T_x[x]$. Choose also a metric $\langle \cdot, \cdot \rangle$ on the vector bundle $\eta \rightarrow M$. Then the differential df defines (by restriction) a smooth section of the dual bundle

$\eta^* \rightarrow M$, and we can use the metric to associate with this a “gradient,” $\nabla f \in \Gamma(\eta)$, defined by

$$\langle \nabla f(x), v \rangle = df(v) \quad \text{for all } v \in \eta_x.$$

Clearly in a neighborhood of $\text{Crit}(f)$, $\nabla f(x)$ vanishes if and only if x is a critical point. Choose next a connection ∇ on the bundle $\eta \rightarrow M$. This induces naturally a connection on $\eta^* \rightarrow M$, which allows us to define $\nabla df \in \Gamma(T^*M \otimes \eta^*)$. By restriction, this may be considered a bilinear form on η .

Proposition A.1.1. *If $x \in \text{Crit}(f)$ then for any $v, w \in \eta_x$, $\nabla df(v, w) = \nabla df(w, v)$.*

Proof. Extend v and w to vector fields $V, W \in \Gamma(TM)$ near x such that $[V, W] = 0$, and write $V = V_\theta + V_\eta \in \theta \oplus \eta$, similarly for W . Then $L_V(df(W_\theta))(x) = 0$ since both W_θ and df vanish at x , and similarly $L_W(df(V_\theta)) = 0$. We compute,

$$\begin{aligned} 0 &= L_V L_W f(x) - L_W L_V f(x) \\ &= L_V(df(W_\eta))(x) - L_W(df(V_\eta))(x) \\ &= (\nabla_v df)(w) + df(\nabla_v W_\eta) - (\nabla_w df)(v) - df(\nabla_w V_\eta) \\ &= \nabla df(v, w) - \nabla df(w, v). \end{aligned}$$

□

Observe that if x is a critical point, the bilinear form $\nabla df(x) : \eta_x \otimes \eta_x \rightarrow \mathbb{R}$ doesn't depend on our choice of connection. The same can be said of the linear map

$$\nabla^2 f(x) = \nabla \nabla f(x) : T_x M \rightarrow \eta_x,$$

though of course this does depend on the metric (because ∇f does). If we choose ∇ to be compatible with the metric, then an easy computation shows

$$\langle \nabla^2 f(x)X, v \rangle = \nabla df(x)(X, v) \quad \text{for all } X \in T_x M \text{ and } v \in \eta_x.$$

Define the *Hessian* of f at x to be the restriction of this operator to

$$\nabla^2 f(x) : \eta_x \rightarrow \eta_x.$$

Then Prop. A.1.1 and the above remarks show that $\nabla^2 f(x)$ is symmetric with respect to the metric $\langle \cdot, \cdot \rangle$ whenever $x \in \text{Crit}(f)$. By definition, the function f is Morse-Bott nondegenerate if and only if $\nabla^2 f(x)$ is an isomorphism at all critical points x .

The Hessian of Φ_λ

To apply the ideas above to the action functional, define a splitting $TC^\infty(S^1, M) = \Theta \oplus \mathcal{E}$ by

$$\Theta_x = \Gamma(x^*(\mathbb{R}X_\lambda)) \quad \text{and} \quad \mathcal{E}_x = \Gamma(x^*\xi),$$

where Θ and \mathcal{E} are thought of as smooth vector bundles over $C^\infty(S^1, M)$. Clearly if $x \in \text{Crit}(\Phi_\lambda)$, i.e. x is a loop parallel to the Reeb vector field, then the tangent space to the orbit $[x] \subset C^\infty(S^1, M)$ is precisely Θ_x . Define the metric $d\lambda(\cdot, J\cdot)$ on the bundle $\xi \rightarrow M$ and use this to define a metric on the bundle $\mathcal{E} \rightarrow C^\infty(S^1, M)$ by

$$\langle v, w \rangle = \int_{S^1} d\lambda(v(t), Jw(t)) dt \quad \text{for } v, w \in \Gamma(x^*\xi). \quad (1.1.1)$$

Then the “gradient” of Φ_λ can be defined as a section of \mathcal{E} by

$$\nabla\Phi_\lambda(x) = -J\pi_\lambda\dot{x} \in \Gamma(x^*\xi),$$

and we have $\langle \nabla\Phi_\lambda(x), v \rangle = d\Phi_\lambda(x)v$ for all $v \in \Gamma(x^*\xi)$. To compute the Hessian, choose any connection on ξ which is Hermitian with respect to the metric $d\lambda(\cdot, J\cdot)$ and complex structure J . This defines a connection on $\mathcal{E} \rightarrow C^\infty(S^1, M)$ which is compatible with $\langle \cdot, \cdot \rangle$. For any $v \in \mathcal{E}_x = \Gamma(x^*\xi)$, find a smooth map $x_s(t) = x(s, t)$ such that $v(t) = \partial_s x(0, t)$, then $\nabla^2\Phi_\lambda(x)v = \nabla_v \nabla\Phi_\lambda$ will be the section in $\Gamma(x^*\xi)$ defined by

$$\begin{aligned} (\nabla_v \nabla\Phi_\lambda)(t) &= \nabla_s (\nabla\Phi_\lambda(x_s)(t))|_{s=0} \\ &= \nabla_s (-J\pi_\lambda\partial_t x(s, t))|_{s=0} = -J\nabla_s(\pi_\lambda\partial_t x(s, t))|_{s=0}. \end{aligned}$$

Assuming $x \in \text{Crit}(\Phi_\lambda)$, the covariant derivative of $\pi_\lambda\partial_t x(s, t)$ at $s = 0$ will not depend on our choice of connection for ξ , since $\pi_\lambda\dot{x}(t) = 0$. We can therefore choose a more convenient connection for the computation; in particular, let ∇ be any *symmetric* connection on M and define a covariant derivative $\tilde{\nabla}$ for sections $v \in \Gamma(\xi)$ by

$$\tilde{\nabla}v = \pi_\lambda \circ \nabla v.$$

It is easily verified that $\tilde{\nabla}$ defines a linear connection on the bundle $\xi \rightarrow M$. Then using the symmetry of ∇ , we compute

$$\begin{aligned} \tilde{\nabla}_s(\pi_\lambda\partial_t x(s, t))|_{s=0} &= \pi_\lambda \nabla_s [\partial_t x(s, t) - \lambda(\partial_t x(s, t)) \cdot X_\lambda(x(s, t))] |_{s=0} \\ &= \pi_\lambda \nabla_t \partial_s x(0, t) - \lambda(\dot{x}(t)) \cdot \pi_\lambda \nabla_s X_\lambda(x(s, t))|_{s=0} \\ &= \pi_\lambda (\nabla_t v(t) - \lambda(\dot{x}(t)) \nabla_{v(t)} X_\lambda). \end{aligned}$$

It turns out that the projection π_λ can be removed, because the expression in parentheses is already a section of $x^*\xi$. Indeed, using again the symmetry of ∇ and the fact that $\dot{x}(t) \in \mathbb{R}X_\lambda(x(t))$,

$$\begin{aligned} \lambda(\nabla_t v(t) - \lambda(\dot{x}(t))\nabla_{v(t)}X_\lambda) &= \lambda(\nabla_t \partial_s x(s, t) - \lambda(\dot{x}(t))\nabla_s X_\lambda(x(s, t))) \Big|_{s=0} \\ &= \lambda(\nabla_s [\partial_t x(s, t) - \lambda(\dot{x}(t))X_\lambda(x(s, t))] \Big|_{s=0}) = \lambda(\nabla_s [\pi_\lambda \partial_t x(s, t)] \Big|_{s=0}) \\ &= \partial_s [\lambda(\pi_\lambda \partial_t x(s, t))] \Big|_{s=0} - (\nabla_s \lambda)(\pi_\lambda \dot{x}(t)) \Big|_{s=0} = 0. \end{aligned}$$

If we choose a parametrization of $x \in \text{Crit}(\Phi_\lambda)$ so that $\lambda(\dot{x}(t)) \equiv T$ (the period of the orbit), we now obtain the following formula for $\nabla^2 \Phi_\lambda(x) : \Gamma(x^*\xi) \rightarrow \Gamma(x^*\xi)$,¹

$$\nabla^2 \Phi_\lambda(x) = -J(\nabla_t - T\nabla X_\lambda).$$

With this as motivation, we associate with any T -periodic orbit $P \subset M$, parametrized by $x : S^1 \rightarrow M$ with $\lambda(\dot{x}) \equiv T$, the *asymptotic operator*

$$\begin{aligned} \mathbf{A}_x &: H^1(x^*\xi) \rightarrow L^2(x^*\xi) \\ \mathbf{A}_x v &= -J(\nabla_t v - T\nabla_v X_\lambda) \end{aligned} \tag{1.1.2}$$

where ∇ is any symmetric connection on M . It must be emphasized that, despite appearances to the contrary, \mathbf{A}_x is necessarily a section of $x^*\xi$, and it depends only on x , λ and J , not on the choice of connection. Moreover, it's not hard to see that different parametrizations $x(t)$ for the same orbit will give conjugate operators. Choosing a unitary trivialization of $x^*\xi \rightarrow S^1$, the operator takes the form

$$\begin{aligned} \mathbf{A}_x &: H^1(S^1, \mathbb{R}^{2n}) \rightarrow L^2(S^1, \mathbb{R}^{2n}) \\ \mathbf{A}_x v &= -J_0 \dot{v}(t) - S_\infty(t)v(t) \end{aligned} \tag{1.1.3}$$

where J_0 is the standard complex structure and S_∞ is a smooth loop of $2n$ -by- $2n$ symmetric matrices.

As one would expect, \mathbf{A}_x is a symmetric operator with respect to the L^2 -inner product defined by (1.1.1). More importantly, it defines an unbounded self-adjoint operator on $L^2(x^*\xi)$, with spectrum $\sigma(\mathbf{A}_x)$ consisting of discrete eigenvalues of finite multiplicity that accumulate only at infinity. The periodic orbit P is nondegenerate if and only if $0 \neq \sigma(\mathbf{A}_x)$. In Sec. 4.2, we also consider Morse-Bott orbits, in which case \mathbf{A}_x has a nontrivial finite-dimensional kernel.

¹The reader should beware that this operator is widely misprinted without the factor of T in the literature. Some authors get away with this by defining S^1 as $\mathbb{R}/T\mathbb{Z}$ instead of \mathbb{R}/\mathbb{Z} —and some of them, maddeningly, do this without saying so explicitly. The author wishes to thank Richard Siefring for clarifying this point.

A.2 Exponential approach

If $\Sigma \setminus \Gamma = \dot{\Sigma}$ is a Riemann surface (possibly with boundary) with interior punctures, and $\tilde{u} = (a, u) : \dot{\Sigma} \rightarrow \mathbb{R} \times M$ is a finite energy \tilde{J} -holomorphic curve, Prop. 1.1.4 says roughly that $u(z)$ approaches some periodic orbit of the Reeb vector field as $z \rightarrow \Gamma$. We now state the precise version of Prop. 1.1.8, which describes the asymptotic approach in the case where the orbit in question is either nondegenerate or Morse-Bott. We'll state only the three-dimensional version proved by Hofer, Wysocki and Zehnder in [HWZ96a] and [HWZ96b], since this will suffice for our purposes.

Recall that each nonremovable puncture $z \in \Gamma$ of a finite energy surface can be characterized as either positive or negative, depending on the sign of the *charge*

$$Q = -\lim_{\epsilon \rightarrow 0} \int_{\partial \mathbb{D}_\epsilon} u^* \lambda,$$

where $D_\epsilon \subset \Sigma$ is a decreasing sequence of holomorphically embedded disks centered at z . It is convenient to associate with each puncture a special holomorphic coordinate system that identifies a punctured neighborhood with one of the half-cylinders

$$Z^+ = [0, \infty) \times S^1 \quad \text{or} \quad Z^- = (-\infty, 0] \times S^1$$

depending on the sign. On the punctured disk $\dot{\mathbb{D}} = \mathbb{D} \setminus \{0\}$, this is defined by

$$\varphi_\pm : Z^\pm \rightarrow \dot{\mathbb{D}} : (s, t) \mapsto e^{\mp 2\pi(s+it)}$$

Then the asymptotic approach in Prop. 1.1.4 can be described conveniently by $u \circ \varphi_\pm(s_k, t) \rightarrow x(Tt)$ as $s_k \rightarrow \pm\infty$.

We will need nice coordinates for neighborhoods of periodic orbits.

Lemma A.2.1 ([HWZ96a] and [HWZ96b]). *Let $x : \mathbb{R} \rightarrow M$ be a T -periodic orbit of X_λ with period $T = k\tau$, where $\tau > 0$ is the minimal period and $k \in \mathbb{N}$ is the covering number. Write $P \subset M$ for the image of x . Then a neighborhood of P in M can be identified with a neighborhood \mathcal{U} of $S^1 \times \{0\} \subset S^1 \times \mathbb{R}^2$ such that*

$$P = S^1 \times \{0\},$$

and using coordinates $(\theta, x, y) \in S^1 \times \mathbb{R}^2$,

$$\lambda = f(d\theta + x dy)$$

for some smooth positive function f defined near P . We may assume

$$f(\theta, 0, 0) = \tau \quad \text{and} \quad df(\theta, 0, 0) = 0$$

for all $\theta \in S^1$. Moreover, if P belongs to a smooth 2-dimensional manifold $L \subset M$ foliated by T -periodic orbits, then we may assume $L \cap \mathcal{U}$ is invariant under the Reeb flow and

$$L \cap \mathcal{U} = \{(\theta, 0, y) \in \mathcal{U}\} \quad \text{and} \quad df(\theta, 0, y) = 0$$

for all $(\theta, 0, y) \in \mathcal{U}$.

Theorem A.2.2 ([HWZ96a] and [HWZ96b]). *Let $\tilde{u} = (a, u) : \mathbb{D} \rightarrow \mathbb{R} \times M$ be a finite energy \tilde{J} -holomorphic map, with (M, λ) a contact 3-manifold, and suppose the T -periodic orbit $x(t)$ (with $T = k\tau = |Q|$) given by Prop. 1.1.4 either is nondegenerate or belongs to a simple Morse-Bott surface. Then, choosing φ_+ or φ_- according to the sign of Q , the asymptotic behavior of the half-cylinder $\tilde{u} \circ \varphi_{\pm} : Z^{\pm} \rightarrow \mathbb{R} \times M$ can be described as follows.*

Using the coordinates of Lemma A.2.1 near $P = x(\mathbb{R})$, write

$$\tilde{u} \circ \varphi_{\pm}(s, t) = (a(s, t), \theta(s, t), z(s, t)) \in \mathbb{R} \times S^1 \times \mathbb{R}^2$$

for some functions a , θ and z . There are constants $a_0 \in \mathbb{R}$ and $\theta_0 \in S^1$ such that either

$$(a(s, t), \theta(s, t), z(s, t)) = (Ts + a_0, kt + \theta_0, 0),$$

or there exists an exponential decay rate $d > 0$ with

$$\begin{aligned} |\partial^{\beta}[a(s, t) - a_0 - Ts]| &\leq Ce^{\mp ds} \\ |\partial^{\beta}[\theta(s, t) - \theta_0 - kt]| &\leq Ce^{\mp ds} \end{aligned}$$

for all multi-indices β , with constants $C = C(\beta)$. In this case, $z(s, t)$ is described by the formula

$$z(s, t) = e^{\int_0^s \mu(\sigma) d\sigma} [e(t) + r(s, t)] \in \mathbb{R}^2,$$

where $\partial^{\beta}r(s, t) \rightarrow 0$ as $s \rightarrow \pm\infty$, uniformly in t for all multi-indices β . Here μ is a smooth real-valued function with

$$\mu(s) \rightarrow \lambda \in \sigma(\mathbf{A}_x) \quad \text{as } s \rightarrow \pm\infty,$$

where the sign of λ is opposite that of the puncture, and $e : S^1 \rightarrow \xi_{(kt, 0, 0)} = \mathbb{R}^2$ is an eigenfunction of \mathbf{A}_x with $\mathbf{A}_x e = \lambda e$.

A.3 A criterion for finite energy

We've seen that finite energy implies asymptotically cylindrical behavior for punctured holomorphic curves. It is occasionally useful to have a converse to this statement. As always, (M, λ) is a closed contact 3-manifold with the usual \mathbb{R} -invariant almost complex structure \tilde{J} on its symplectization $\mathbb{R} \times M$.

Proposition A.3.1. *Let Σ be a compact oriented surface, possibly with boundary, and define $\dot{\Sigma} = \Sigma \setminus \Gamma$ where $\Gamma \subset \text{int } \Sigma$ is a finite set of interior punctures. Assume j is a complex structure on $\dot{\Sigma}$ (not necessarily extending over Σ), and we are given a pseudoholomorphic curve $\tilde{u} = (a, u) : (\dot{\Sigma}, j) \rightarrow (\mathbb{R} \times M, \tilde{J})$ with the property that for each puncture $z_j \in \Gamma$, there is a shrinking sequence of circles $\gamma_j^k : S^1 \rightarrow \dot{\Sigma}$ winding clockwise around z_j , and a periodic orbit $x_j : \mathbb{R} \rightarrow M$ of X_λ with period $T_j = |Q_j| > 0$ such that as $k \rightarrow \infty$,*

$$u \circ \gamma_j^k(t) \rightarrow x_j(Q_j t) \quad \text{in } C^1(S^1, M).$$

Then \tilde{u} has finite energy

$$E(\tilde{u}) = \sup_{\varphi \in \mathcal{T}_0} \int_{\dot{\Sigma}} \tilde{u}^* d(\varphi \lambda) < \infty,$$

and the following two statements are equivalent:

(i) $a : \dot{\Sigma} \rightarrow \mathbb{R}$ is a proper map.

(ii) There is a compact Riemann surface (Σ', j') and a finite set $\Gamma' \subset \text{int } \Sigma'$ such that the punctured Riemann surface $(\Sigma' \setminus \Gamma', j')$ is biholomorphic to $(\dot{\Sigma}, j)$. That is, \tilde{u} can be reparametrized near the punctures so that j extends over Σ .

Proof. To establish finite energy, choose a sequence of compact subsets $\Sigma_k \subset \dot{\Sigma}$ bounded by the shrinking circles,

$$\partial \Sigma_k = \partial \Sigma \cup \left(\bigcup_{z_j \in \Gamma} \gamma_j^k(S^1) \right).$$

Then using Stokes' theorem and the fact that $\tilde{u}^* d(\varphi \lambda)$ is always nonnegative,

$$\begin{aligned} \int_{\dot{\Sigma}} \tilde{u}^* d(\varphi \lambda) &= \lim_k \int_{\Sigma_k} \tilde{u}^* d(\varphi \lambda) = \int_{\partial \Sigma} \tilde{u}^*(\varphi \lambda) + \sum_{z_j \in \Gamma} \lim_k \int_{\gamma_j^k(S^1)} \tilde{u}^*(\varphi \lambda) \\ &\leq \int_{\partial \Sigma} |u^* \lambda| + \sum_{T_j > 0} T_j, \end{aligned}$$

so this number bounds $E(\tilde{u})$.

Now it follows immediately from the properties of finite energy holomorphic curves that (ii) implies (i). Conversely, suppose there is no reparametrization allowing j to extend over one of the punctures $z_j \in \Gamma$. From the classification of

conformal structures on annuli, we know that a closed punctured neighborhood of z_j in $(\dot{\Sigma}, j)$ is conformally equivalent to either $([0, \infty) \times S^1, i)$ or $([0, R) \times S^1, i)$ for some $R > 0$ (see [Hm97], Lemma 5.1). It must in fact be the latter, since the former is biholomorphic to a punctured disk. Thus we can describe a neighborhood of z_j by holomorphic coordinates $(s, t) \in [0, R) \times S^1$, and treat the circles γ_j^k as embeddings $S^1 \hookrightarrow [0, R) \times S^1$ for sufficiently large k . Now for $s \in [0, R)$ sufficiently close to R , we can choose k and $k' > k$ so that $\{s\} \times S^1$ is contained in an annulus bounded by $\gamma_j^k(S^1)$ and $\gamma_j^{k'}(S^1)$. Then Stokes' theorem and the positivity of $u^*d\lambda$ imply

$$\int_{\gamma_j^k(S^1)} u^*\lambda < \int_{\{s\} \times S^1} u^*\lambda < \int_{\gamma_j^{k'}(S^1)} u^*\lambda,$$

consequently $\int_{\{s\} \times S^1} u^*\lambda \rightarrow Q_j$ as $s \rightarrow R$. The Cauchy-Riemann equations give $a_s = \lambda(u_t)$, and thus

$$\begin{aligned} \lim_{s \rightarrow R} \int_{S^1} a(s, t) dt &= \int_{S^1} a(0, t) dt + \int_0^R \int_{S^1} a_s(s, t) dt ds \\ &= \int_{S^1} a(0, t) dt + \int_0^R \int_{S^1} \lambda(u_t(s, t)) dt ds \\ &= \int_{S^1} a(0, t) dt + \int_0^R \left(\int_{\{s\} \times S^1} u^*\lambda \right) ds. \end{aligned}$$

This integral is finite, proving that a is not a proper map. □

Appendix B

Deligne-Mumford For Surfaces with Boundary

B.1 Nodal surfaces

The main compactness result of Chapter 5 deals with sequences of holomorphic curves on punctured Riemann surfaces with boundary, thus we need to understand the compactification of the space of conformal structures on such a domain. A useful version of the Deligne-Mumford compactness theorem for Riemann surfaces without boundary was stated in [BEHWZ03]. Here we shall review that result, and use doubling arguments to state a generalization to the case where $\partial\Sigma \neq \emptyset$. A valuable reference for this material is the book by Seppälä and Sorvali [SS92].

The unfamiliar reader may wish to skip to the end and contemplate Figure B.2 before proceeding.

Let (Σ, j) be a compact connected Riemann surface, possibly with boundary, and let $\Gamma \subset \text{int } \Sigma$ be a finite *ordered* subset. As usual, denote the corresponding punctured surface by $\dot{\Sigma} = \Sigma \setminus \Gamma$. If the Euler characteristic $\chi(\dot{\Sigma}) < 0$, then we call the triple (Σ, j, Γ) a *stable Riemann surface with boundary and interior marked points*. The stability condition means

$$2g + m + \#\Gamma > 2,$$

where g is the genus of Σ and m is the number of boundary components. Recall that there is a natural “conjugate” Riemann surface $(\Sigma^c, j^c) = (\Sigma, -j)$, which can be glued to (Σ, j) along $\partial\Sigma$ to form a surface without boundary $\Sigma^D = \Sigma \cup_{\partial\Sigma} \Sigma^c$. The double Σ^D has a natural conformal structure j^D (see Remark 4.2.9) and a natural antiholomorphic involution $\sigma : \Sigma^D \rightarrow \Sigma^D$ whose fixed point set is $\partial\Sigma$. We can also double the set of marked points to define $(\Sigma^D, j^D, \Gamma^D)$ and a punctured surface

without boundary $\dot{\Sigma}^D = \Sigma^D \setminus \Gamma^D$; then an equivalent definition of stability is to say that (Σ, j, Γ) is stable if and only if $\chi(\dot{\Sigma}^D) < 0$. This definition has the advantage of making sense also when marked points are allowed on the boundary.

It is a standard fact that every Riemann surface without boundary and with negative Euler characteristic admits a unique complete metric that is compatible with the conformal structure and has constant curvature -1 . This follows easily from the uniformization theorem, since any such surface has the Poincaré disk as its universal cover (cf. [Hm97]). This metric is then called the *Poincaré metric*. Because it is unique, the space of orientation preserving isometries with respect to this metric can be identified with the space of biholomorphic maps. Given a stable Riemann surface (Σ, j, Γ) with boundary and interior marked points, we define a metric h on $\dot{\Sigma}$ by restricting the Poincaré metric h^D of $(\dot{\Sigma}^D, j^D)$ to the subset $\dot{\Sigma} \subset \dot{\Sigma}^D$. Then the involution $\sigma : \Sigma^D \rightarrow \Sigma^D$ is an orientation reversing isometry of $(\dot{\Sigma}^D, h^D)$, and one can use this fact to prove that each component of $\partial\Sigma$ is a geodesic for h . We shall refer to h as the Poincaré metric for $(\dot{\Sigma}, j)$.

Denote by $\mathcal{M}_{g,m,p}$ the moduli space of equivalence classes of compact connected Riemann surfaces (Σ, j, Γ) with genus g , $m \geq 0$ boundary components and $p = \#\Gamma$ interior marked points $\Gamma \subset \text{int } \Sigma$. Recall that the points of Γ come with an ordering. Equivalence $(\Sigma, j, \Gamma) \sim (\Sigma', j', \Gamma')$ means that there exists a biholomorphic map $\varphi : (\Sigma, j) \rightarrow (\Sigma', j')$ that takes Γ to Γ' , preserving the ordering. The topology on $\mathcal{M}_{g,m,p}$ is defined by saying that $[(\Sigma_k, j_k, \Gamma_k)] \rightarrow [(\Sigma, j, \Gamma)]$ if for sufficiently large k there exist diffeomorphisms $\varphi_k : \Sigma \rightarrow \Sigma_k$ mapping $\Gamma \rightarrow \Gamma_k$ (with the right ordering) and such that $\varphi_k^* j_k \rightarrow j$ in C^∞ .

Using the Schwartz reflection principle, any biholomorphic map $\varphi : (\Sigma_1, j_1) \rightarrow (\Sigma_2, j_2)$ extends naturally to a biholomorphic map $\varphi^D : (\Sigma_1^D, j_1^D) \rightarrow (\Sigma_2^D, j_2^D)$. It follows that there is a well defined continuous map

$$\mathcal{M}_{g,m,p} \rightarrow \mathcal{M}_{2g+m-1,0,2p} : [(\Sigma, j, \Gamma)] \mapsto [(\Sigma^D, j^D, \Gamma^D)].$$

We shall use this and the natural compactification $\overline{\mathcal{M}}_{2g+m-1,0,2p}$ to define the compactification $\overline{\mathcal{M}}_{g,m,p}$.

Let us review the case where $\partial\Sigma = \emptyset$, following the presentation in [BEHWZ03]. A *nodal Riemann surface* $\Sigma = (\Sigma, j, \Gamma, \Delta)$ consists of a Riemann surface (Σ, j) which is a finite union of disjoint closed, connected surfaces $\Sigma = \Sigma_1 \cup \dots \cup \Sigma_q$, together with an ordered set of marked points $\Gamma \subset \Sigma$ and a set of so-called *double points* Δ . The latter is an unordered set of unordered pairs of points in Σ , $\Delta = \{\{z_1, z'_1\}, \dots, \{z_d, z'_d\}\}$, with $z_j \neq z'_j$ for each pair. When there is no confusion, we shall sometimes abuse notation and treat Δ as an ordinary set of points, rather than a set of pairs; we assume the sets Δ and Γ are disjoint. Intuitively one thinks of Σ

as the topological space obtained from Σ by identifying each pair of double points:

$$\widehat{\Sigma} = \Sigma / \{z_j \sim z'_j \text{ for each pair } \{z_j, z'_j\} \in \Delta\}.$$

The point in $\widehat{\Sigma}$ determined by a given pair of double points $\{z_j, z'_j\} \in \Delta$ is called a *node*. We say that Σ is *connected* whenever $\widehat{\Sigma}$ is connected. Σ is called *stable* if for each connected component $\Sigma_j \subset \Sigma$, the surface $(\Sigma_j, j|_{\Sigma_j}, (\Gamma \cup \Delta) \cap \Sigma_j)$ is stable; this means that every connected component of $\Sigma \setminus (\Gamma \cup \Delta)$ has negative Euler characteristic.

There is another important connected space associated to a connected nodal surface Σ ; in order to define it we must add some extra data at each double point. An *asymptotic marker* at $z \in \Delta$ is a choice of direction $\mu \in (T_z \Sigma \setminus \{0\})/\mathbb{R}_+$, where \mathbb{R}_+ is the group of positive real numbers, acting by scalar multiplication. A choice of asymptotic markers $r = \{\{\mu_1, \mu'_1\}, \dots, \{\mu_d, \mu'_d\}\}$ for every pair of double points $\{z_j, z'_j\} \in \Delta$ is called a *decoration*, and we then call $(\Sigma, r) = (\Sigma, j, \Gamma, \Delta, r)$ a *decorated nodal Riemann surface*. For each pair $\{z, z'\} \in \Delta$ with asymptotic markers $\{\mu, \mu'\}$, the conformal structure j determines a natural choice of orientation reversing map

$$r_z : (T_z \Sigma \setminus \{0\})/\mathbb{R}_+ \rightarrow (T_{z'} \Sigma \setminus \{0\})/\mathbb{R}_+$$

such that $r_z(\mu) = \mu'$. These maps have an important interpretation in terms of the circle compactification at a puncture. Namely, for each component $\Sigma_j \subset \Sigma$, let $\overline{\Sigma}_j$ be the compact surface with boundary obtained from the punctured surface $\Sigma_j \setminus (\Delta \cap \Sigma_j)$ by replacing each puncture $z \in \Delta \cap \Sigma_j$ with a ‘‘circle at infinity’’ $\delta_z \cong (T_z \Sigma_j \setminus \{0\})/\mathbb{R}_+$ (cf. Sec. 4.2). Then $\partial \overline{\Sigma}_j = \bigcup_{z \in \Delta \cap \Sigma_j} \delta_z$, and for a pair $\{z, z'\} \in \Delta$, the map r_z determines an orientation reversing diffeomorphism $\bar{r}_z : \delta_z \rightarrow \delta_{z'}$. Denote

$$\overline{\Sigma}_r = (\overline{\Sigma}_1 \sqcup \dots \sqcup \overline{\Sigma}_q) / \{w \sim \bar{r}_z(w) \text{ for all } w \in \delta_z\}.$$

This is a closed surface and is connected if and only if $\widehat{\Sigma}$ is connected. In that case, we define the *arithmetic genus* of Σ to be the genus of $\overline{\Sigma}_r$. Note that this number doesn't depend on the choice of the decoration r . We shall denote the union of the special circles δ_z for $z \in \Delta$ by $\Theta_\Delta \subset \overline{\Sigma}_r$. The conformal structure j on Σ defines a singular conformal structure j_Σ on $\overline{\Sigma}_r$, which degenerates at Θ_Δ . If Σ is stable, then there is similarly a ‘‘singular Poincaré metric’’ h_Σ on $\overline{\Sigma}_r$, defined by choosing the Poincaré metric on each of the punctured components $\dot{\Sigma}_j := \Sigma_j \setminus ((\Gamma \cup \Delta) \cap \Sigma_j)$. This metric degenerates at $\Theta_\Delta \cup \Gamma$; in particular the distance from a marked point $z_0 \in \Gamma$ or a circle $\delta_z \subset \Theta_\Delta$ to any other point in $\overline{\Sigma}$ is infinite, and the circles δ_z have length 0. Observe that in the stable case, $\overline{\Sigma}_r \setminus \Gamma$ is a union of pieces $\overline{\Sigma}_j \setminus (\Gamma \cap \Sigma_j)$ with negative Euler characteristic glued along boundary circles, thus $\chi(\overline{\Sigma}_r \setminus \Gamma) < 0$.

In particular, if $\Sigma = (\Sigma, j, \Gamma, \Delta)$ is a stable nodal Riemann surface with arithmetic genus g , then $2g + \#\Gamma > 2$.

Assume $2g+p > 2$ and let $\overline{\mathcal{M}}_{g,0,p}$ denote the moduli space of equivalence classes of stable nodal Riemann surfaces $\Sigma = (\Sigma, j, \Gamma, \Delta)$ with arithmetic genus g and $p = \#\Gamma$ marked points. We say $(\Sigma, j, \Gamma, \Delta) \sim (\Sigma', j', \Gamma', \Delta')$ if there is a biholomorphic map $\varphi : (\Sigma, j) \rightarrow (\Sigma', j')$ taking Γ to Γ' with the proper ordering, and such that $\{\varphi(z_1), \varphi(z_2)\} \in \Delta'$ if and only if $\{z_1, z_2\} \in \Delta$. There is a natural inclusion $\mathcal{M}_{g,0,p} \hookrightarrow \overline{\mathcal{M}}_{g,0,p}$ defined by assigning at any stable Riemann surface (Σ, j, Γ) an empty set of double points.

To define the topology of $\overline{\mathcal{M}}_{g,0,p}$, we introduce the following notion of convergence.

Definition B.1.1. *A sequence $[\Sigma_k] = [(\Sigma_k, j_k, \Gamma_k, \Delta_k)] \in \overline{\mathcal{M}}_{g,0,p}$ converges to $[\Sigma] = [(\Sigma, j, \Gamma, \Delta)] \in \overline{\mathcal{M}}_{g,0,p}$ if there are decorations r_k for Σ_k and r for Σ , and diffeomorphisms $\varphi_k : \overline{\Sigma}_r \rightarrow (\overline{\Sigma}_k)_{r_k}$, for sufficiently large k , with the following properties:*

1. φ_k sends Γ to Γ_k , preserving the ordering.
2. $\varphi_k^* j_k \rightarrow j_\Sigma$ in $C_{\text{loc}}^\infty(\overline{\Sigma}_r \setminus \Theta_\Delta)$.
3. $\varphi_k^{-1}(\Theta_{\Delta_k}) \subset \Theta_\Delta$, and all circles in $\varphi_k(\Theta_\Delta) \setminus \Theta_{\Delta_k}$ are closed geodesics for the Poincaré metric h_{Σ_k} on $(\overline{\Sigma}_k)_{r_k}$.

This definition is compatible with a metric on $\overline{\mathcal{M}}_{g,0,p}$, thus compactness is equivalent to sequential compactness (cf. [BEHWZ03], Appendix B).

Theorem B.1.2 (Deligne-Mumford). *$\overline{\mathcal{M}}_{g,0,p}$ is compact. In particular, any sequence of stable Riemann surfaces $(\Sigma_k, j_k, \Gamma_k)$ with fixed genus and number of marked points has a subsequence convergent to a stable nodal Riemann surface $(\Sigma, j, \Gamma, \Delta)$.*

B.2 Symmetric nodal surfaces and boundaries

In order to extend these notions to the case of a Riemann surface with boundary, we use the doubling operation to think of $[(\Sigma, j, \Gamma)] \in \mathcal{M}_{g,m,p}$ as a stable Riemann surface without boundary $[(\Sigma^D, j^D, \Gamma^D)] \in \mathcal{M}_{2g+m-1,0,2p}$, but with an extra piece of structure: (Σ^D, j^D) comes with a natural antiholomorphic involution $\sigma : \Sigma^D \rightarrow \Sigma^D$ which permutes Γ^D , and whose fixed point set is precisely $\partial\Sigma \subset \Sigma^D$. Given any biholomorphic map $\varphi : \Sigma_1 \rightarrow \Sigma_2$, the involutions $\sigma_i : \Sigma_i^D \rightarrow \Sigma_i^D$ for $i \in \{1, 2\}$ are related to the induced biholomorphic map $\varphi^D : \Sigma_1^D \rightarrow \Sigma_2^D$ by

$$\varphi^D \circ \sigma_1 = \sigma_2 \circ \varphi^D.$$

We therefore define a moduli space of *symmetric Riemann surfaces* $\mathcal{M}_{g,0,p}^s$, containing equivalence classes $[(\Sigma, j, \Gamma, \sigma)]$, where $[(\Sigma, j, \Gamma)] \in \mathcal{M}_{g,0,p}$ and $\sigma : \Sigma \rightarrow \Sigma$ is a diffeomorphism which permutes Γ and satisfies $T\sigma \circ j = -j \circ T\sigma$, as well as $\sigma \circ \sigma = \text{Id}$. Equivalence $(\Sigma, j, \Gamma, \sigma) \sim (\Sigma', j', \Gamma', \sigma')$ is defined by a biholomorphic map $\varphi : (\Sigma, j) \rightarrow (\Sigma', j')$ that takes Γ to Γ' with the right ordering and satisfies $\varphi \circ \sigma = \sigma' \circ \varphi$. Similarly we define convergence in $\mathcal{M}_{g,0,p}^s$ just as in $\mathcal{M}_{g,0,p}$, but require also that the diffeomorphisms $\varphi_k : \Sigma \rightarrow \Sigma_k$ should commute with the corresponding involutions.

By construction, the natural map $\mathcal{M}_{g,m,p} \rightarrow \mathcal{M}_{2g+m-1,0,2p}^s$ defined by the doubling operation is a continuous inclusion. It should be noted that not every symmetric Riemann surface can be presented as the double of some surface with boundary, e.g. there is the involution $z \mapsto -1/\bar{z}$ on S^2 , which has no fixed points. But it is easy to see that any such symmetric surface in $\mathcal{M}_{2g+m-1,0,2p}^s$ is in a separate connected component from the image of $\mathcal{M}_{g,m,p}$. See [SS92] for a discussion of some other kinds of beasts that live in $\mathcal{M}_{2g+m-1,0,2p}^s$.

The notion of a symmetric Riemann surface extends naturally to the compactification: thus we define a moduli space $\overline{\mathcal{M}}_{g,0,p}^s$ of *symmetric nodal Riemann surfaces* $(\Sigma, \sigma) = (\Sigma, j, \Gamma, \Delta, \sigma)$. Here $\Sigma \in \overline{\mathcal{M}}_{g,0,p}$, and $\sigma : \Sigma \rightarrow \Sigma$ is an antiholomorphic involution which permutes Γ and has the additional property that $\{z_1, z_2\} \in \Delta$ if and only if $\{\sigma(z_1), \sigma(z_2)\} \in \Delta$. Equivalence in $\overline{\mathcal{M}}_{g,0,p}^s$ is defined the same as in $\overline{\mathcal{M}}_{g,0,p}$, with the added condition that the biholomorphic map φ must commute with the respective involutions. There is a well defined continuous involution defined by σ on the singular surface $\widehat{\Sigma}$. This can be defined on $\overline{\Sigma}_r$ as well if the decoration r is *symmetric*: this means that the set of asymptotic markers is preserved by $T\sigma$. Then one easily verifies that for any $\{z, z'\} \in \Delta$, the orientation reversing diffeomorphism $\bar{r}_z : \delta_z \rightarrow \delta_{z'}$ commutes with σ , so σ defines an involution on $\overline{\Sigma}_r$, which preserves Θ_Δ and is antiholomorphic on $\overline{\Sigma}_r \setminus \Theta_\Delta$.

With this preparation, we can define convergence in $\overline{\mathcal{M}}_{g,0,p}^s$ just as in Definition B.1.1, requiring additionally that all decorations be symmetric, and that the diffeomorphisms $\varphi_k : \overline{\Sigma}_r \rightarrow (\overline{\Sigma}_k)_{r_k}$ commute with the respective involutions. With this topology, $\overline{\mathcal{M}}_{g,0,p}^s$ is compact.¹

We conclude this discussion by translating the results for symmetric Riemann surfaces back into the language of surfaces with boundary. Consider a sequence

¹Seppälä and Sorvali [SS92] prove this in the case where $p = 0$, using symmetric pair of pants decompositions. One can extend their arguments to the case with marked points using degenerate pair of pants decompositions, where each “boundary” component for a pair of pants is either a closed geodesic or a *puncture* representing a marked point, and all marked points are accounted for in this way (cf. Hummel [Hm97]). In this picture, marked points play much the same role as nodes.

$[(\Sigma_k, j_k, \Gamma_k)] \in \mathcal{M}_{g,m,p}$ such that the doubles $[(\Sigma_k^D, j_k^D, \Gamma_k^D, \sigma_k)] \in \mathcal{M}_{2g+m-1,0,p}^s$ converge to a symmetric nodal surface

$$[(\Sigma_\infty, \sigma_\infty)] = [(\Sigma_\infty, j_\infty, \Gamma_\infty, \Delta_\infty, \sigma_\infty)] \in \overline{\mathcal{M}}_{2g+m-1,0,p}^s.$$

There is a symmetric decoration r and a set of diffeomorphisms $\varphi_k : (\overline{\Sigma}_\infty)_r \rightarrow \Sigma_k^D$ for large k , satisfying the conditions of Definition B.1.1 and $\varphi_k \circ \sigma_\infty = \sigma_k \circ \varphi_k$. It follows that there is a surface $\overline{\Sigma}$ with boundary $\partial\overline{\Sigma} \cong \text{Fix}(\sigma_\infty) \subset (\overline{\Sigma}_\infty)_r$, such that the topological double of $\overline{\Sigma}$ is $\overline{\Sigma}^D = (\overline{\Sigma}_\infty)_r$. Moreover there are diffeomorphisms $\psi_k : \overline{\Sigma} \rightarrow \Sigma_k$ such that $\varphi_k = \psi_k^D$. The singular conformal structure on $\overline{\Sigma}_r$ restricts to $\overline{\Sigma}$, where it degenerates along a compact 1-dimensional submanifold $\Theta_\Delta \cap \overline{\Sigma}$. There are now two novel features: one is that $\Theta_\Delta \cap \overline{\Sigma}$ may include components of $\partial\overline{\Sigma}$; these correspond to pairs $\{z, z'\} \in \Delta_\infty$ for which $\sigma(z) = z'$, and they arise from components of $\partial\Sigma_k$ which shrink to zero length in the Poincaré metric h_k as $k \rightarrow \infty$. There may also be circles in Θ_Δ that intersect $\partial\Sigma$ transversely, in which case $\Theta_\Delta \cap \overline{\Sigma}$ contains arcs with endpoints on $\partial\Sigma$. These arcs shrink to zero length as $k \rightarrow \infty$, producing pairs of double points $\{z, z'\}$ that are each fixed points of σ , i.e. double points on the boundary.

This picture inspires the following definition. A *nodal Riemann surface with boundary and interior marked points* $\Sigma = (\Sigma, j, \Gamma, \Delta, N)$ consists of a Riemann surface (Σ, j) with finitely many connected components $\Sigma = \Sigma_1 \cup \dots \cup \Sigma_q$, each of which is a compact surface, possibly with boundary. The marked point set Γ is a finite ordered set of interior points, and the double points $\Delta = \{\{z_1, z'_1\}, \dots, \{z_d, z'_d\}\}$ have the property that $z_j \in \partial\Sigma$ if and only if $z'_j \in \partial\Sigma$. We also now have a finite unordered set N of interior points, which we'll call *unpaired nodes*. These are meant to be thought of as boundary components that have degenerated to zero length in the Poincaré metric. We assume the sets Γ , Δ and N are all disjoint. The singular surface $\widehat{\Sigma}$ is defined from Σ as before by identifying pairs of double points in Δ . We then call Σ connected if $\widehat{\Sigma}$ is connected. A decoration r consists of a choice of asymptotic marker for each interior double point. Asymptotic markers for double points at the boundary are unnecessary because the boundary itself defines a preferred direction at these points. Analogously to the circle compactification at an interior puncture, we can define the “arc compactification” at $z \in \Delta \cap \partial\Sigma$ as follows: choose holomorphic coordinates identifying z with $0 \in \mathbb{D}^+$, and use the biholomorphic map

$$\varphi : [0, \infty) \times [0, 1] \rightarrow \mathbb{D}^+ : (s, t) \mapsto e^{-\pi(s+it)}$$

to identify the punctured neighborhood of z with the half-strip $[0, \infty) \times [0, 1]$. We then compactify $\Sigma \setminus \{z\}$ by adding the “arc at infinity” $\delta_z \cong \{\infty\} \times [0, 1]$. For a

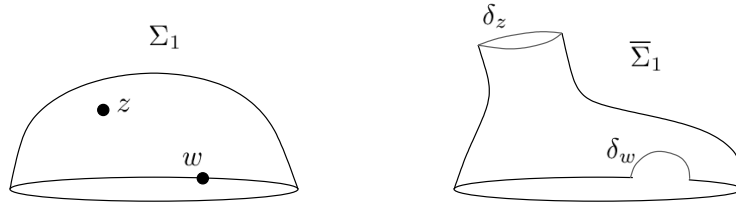

Figure B.1: A component Σ_1 with its compactification $\bar{\Sigma}_1$. Here there's one interior double point $z \in \Delta \cap \text{int } \Sigma_1$ and one boundary double point $w \in \Delta \cap \partial \Sigma_1$.

connected component $\Sigma_j \subset \Sigma$, denote by $\bar{\Sigma}_j$ the compact topological surface with boundary obtained by replacing each interior double point $z \in \Delta \cap \text{int } \Sigma_j$ and each unpaired node $z \in N \cap \Sigma_j$ with a circle at infinity, and replacing each boundary double point $z \in \Delta \cap \partial \Sigma_j$ with an arc at infinity (Figure B.1.) If $\{z, z'\} \in \Delta$ is a pair of double points in $\partial \Sigma$, then the conformal structure defines a preferred orientation reversing diffeomorphism $\delta_z \rightarrow \delta_{z'}$. We then define the compact surface $\bar{\Sigma}_r$ from $\bar{\Sigma}_1 \cup \dots \cup \bar{\Sigma}_q$ by gluing δ_z and $\delta_{z'}$ via this diffeomorphism, and identifying the circles at infinity for interior double points via the decoration r . The circles δ_z corresponding to unpaired nodes $z \in N$ become components of the boundary $\partial \bar{\Sigma}_r$.

As before, we call the genus of $\bar{\Sigma}_r$ the *arithmetic genus* of Σ . The *double* of Σ is defined to be the symmetric nodal Riemann surface $(\Sigma^D, \sigma) = (\Sigma^D, j^D, \Gamma^D, \Delta^D, \sigma)$ where Δ^D contains each pair $\{z, z'\} \in \Delta$ in addition to its conjugate $\{\sigma(z), \sigma(z')\}$, as well as the pair $\{z, \sigma(z)\}$ for each $z \in N$. Clearly Σ^D is connected if and only if Σ is. There are natural inclusions

$$\begin{aligned} \widehat{\Sigma} &\hookrightarrow \widehat{\Sigma}^D \\ \bar{\Sigma}_r &\hookrightarrow \bar{\Sigma}_{r^D}^D \end{aligned}$$

where r^D is defined as the unique symmetric decoration determined by r and some arbitrary choice of asymptotic markers for the points of N (this choice has no effect on the construction of $\bar{\Sigma}_{r^D}^D$).

We shall call Σ stable if every component of (Σ, j) is stable, considered as a Riemann surface with the marked point set $\Gamma \cup \Delta \cup N$. Note that since some points of Δ may lie on $\partial \Sigma$, this means by definition that every component of $\Sigma \setminus (\Gamma \cup \Delta \cup N)$ has a *double* with negative Euler characteristic. Equivalently, Σ is stable if and only if Σ^D is stable. Then we define a singular Poincaré metric h_Σ as the restriction of h_{Σ^D} to $\bar{\Sigma}_r \subset \bar{\Sigma}_{r^D}^D$. This metric degenerates at the marked points Γ and along a finite set of circles and arcs $\Theta_{\Delta, N}$; each of the circles is contained in either the interior or the boundary of $\bar{\Sigma}_r$, and each arc is contained in the interior except at its endpoints,

where it meets $\partial\overline{\Sigma}_r$ transversely.² Note that if Σ is stable then $\chi(\overline{\Sigma}_r \setminus \Gamma) < 0$.

If $2g + m + p > 2$, define $\overline{\mathcal{M}}_{g,m,p}$ to be the moduli space of equivalence classes of stable nodal Riemann surfaces with boundary and interior marked points $\Sigma = (\Sigma, j, \Gamma, \Delta, N)$, with arithmetic genus g , $\#\Gamma = p$ and m connected components of $\partial\overline{\Sigma}_r$. Equivalence $(\Sigma, j, \Gamma, \Delta, N) \sim (\Sigma', j', \Gamma', \Delta', N')$ means there is a biholomorphic map $\varphi : (\Sigma, j) \rightarrow (\Sigma', j')$ that identifies the ordered sets Γ and Γ' , identifies pairs in Δ with pairs in Δ' , and such that $\varphi(N) = N'$. There is a natural inclusion $\mathcal{M}_{g,m,p} \hookrightarrow \overline{\mathcal{M}}_{g,m,p}$ defined by choosing empty sets of double points and unpaired nodes. There is also an inclusion $\overline{\mathcal{M}}_{g,m,p} \hookrightarrow \overline{\mathcal{M}}_{2g+m-1,0,p}^s$ defined by the doubling operation.

With these definitions, the notion of convergence introduced for $m = 0$ in Definition B.1.1 carries over verbatim to $\overline{\mathcal{M}}_{g,m,p}$, after adding one detail:

4. $\varphi_k^{-1}(\Theta_{\Delta_k, N_k}) \subset \Theta_{\Delta, N}$, and all arcs in $\varphi_k(\Theta_{\Delta, N}) \setminus \Theta_{\Delta_k, N_k}$ are geodesic arcs for the Poincaré metric h_{Σ_k} , with endpoints on $\partial((\overline{\Sigma}_k)_{r_k})$.

One sees readily that the topology defined in this way is equivalent to the topology defined by the inclusion $\overline{\mathcal{M}}_{g,m,p} \hookrightarrow \overline{\mathcal{M}}_{2g+m-1,0,p}^s$. We summarize the compactness theorem as follows. Figure B.2 shows an example.

Theorem B.2.1. *$\overline{\mathcal{M}}_{g,m,p}$ is compact. In particular, any sequence of stable Riemann surfaces $(\Sigma_k, j_k, \Gamma_k)$ with boundary and interior marked points, having fixed topological type and number of marked points, has a subsequence convergent (in the sense of Definition B.1.1) to a stable nodal Riemann surface $(\Sigma, j, \Gamma, \Delta, N)$ with boundary and interior marked points.*

²The original version of this appendix stated erroneously that an arc in $\Theta_{\Delta, N}$ always connects the same component of $\partial\Sigma$ at its two ends. A counterexample to this is shown in Figure B.2; thanks to Kai Cieliebak for pointing out the error.

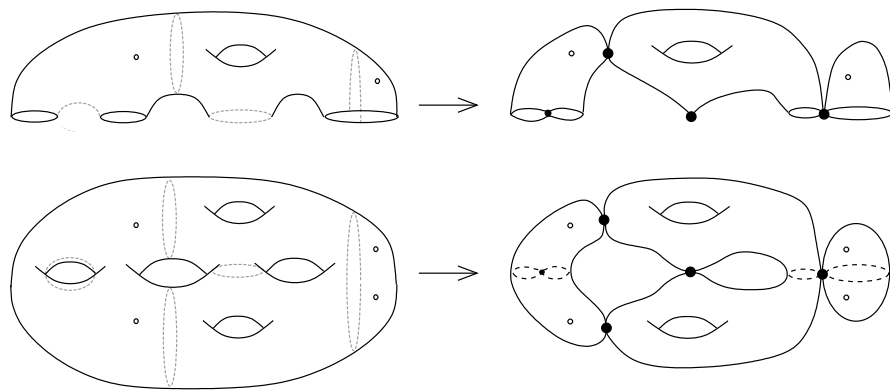

Figure B.2: Degeneration of a stable Riemann surface (Σ, j, Γ) with genus 1, four boundary components and two interior marked points, together with its symmetric double $(\Sigma^D, j^D, \Gamma^D, \sigma)$. The lightly shaded curves on the left are the geodesic loops and arcs that shrink to zero length in the limit. The right side shows the corresponding singular surfaces $\widehat{\Sigma}$ and $\widehat{\Sigma}^D$ after degeneration; $\widehat{\Sigma}$ has one interior double point, two boundary double points and one unpaired node.

Bibliography

- [A03] C. Abbas, Pseudoholomorphic strips in symplectizations III: embedding properties and compactness. preprint SG/0307078.
- [ACH04] C. Abbas, K. Cieliebak, H. Hofer, The Weinstein conjecture for planar contact structures in dimension three. preprint SG/0409355.
- [AH] C. Abbas and H. Hofer, *Holomorphic curves and global questions in contact geometry*. to appear in Birkhäuser.
- [ADN64] S. Agmon, A. Douglis, L. Nirenberg, Estimates near the Boundary for Solutions of Elliptic Partial Differential Equations Satisfying General Boundary Conditions II. *Comm. Pure Appl. Math.*, 17:35–92, 1964.
- [Be83] D. Bennequin, Entrelacements et équations de Pfaff. *Astérisque*, 107-108:83–161, 1983.
- [Bo02] F. Bourgeois, *A Morse-Bott approach to Contact Homology*. PhD Thesis, Stanford University, 2002.
- [BEHWZ03] F. Bourgeois, Y. Eliashberg, H. Hofer, K. Wysocki and E. Zehnder, Compactness results in Symplectic Field Theory. preprint SG/0308183.
- [BoM03] F. Bourgeois, K. Mohnke, Coherent orientations in symplectic field theory. preprint SG/0102095.
- [CGH02] V. Colin, E. Giroux and K. Honda, On the coarse classification of tight contact structures. preprint GT/0305186.
- [DG03] F. Ding and H. Geiges, A Legendrian surgery presentation of contact 3-manifolds. preprint SG/0107045.
- [DN55] A. Douglis, L. Nirenberg, Interior estimates for elliptic systems of partial differential equations. *Comm. Pure Appl. Math.*, 8:503–538, 1955.

- [Dr04] D. L. Dragnev, Fredholm theory and transversality for noncompact pseudo-holomorphic maps in symplectizations, *Comm. Pure Appl. Math.*, 57:726–763, 2004.
- [EES02] T. Ekhholm, J. Etnyre, M. Sullivan, Legendrian Submanifolds in \mathbb{R}^{2n+1} and Contact Homology. preprint SG/0210124.
- [E89] Y. Eliashberg, Classification of overtwisted contact structures on 3-manifolds. *Inv. Math.*, 623–637, 1989.
- [E92] Y. Eliashberg, Contact 3-manifolds, twenty years since J. Martinet’s work. *Ann. Inst. Fourier*, 42:165–192, 1992.
- [EGH00] Y. Eliashberg, A. Givental and H. Hofer, Introduction to Symplectic Field Theory. *Geom. Funct. Anal.*, Special Volume, Part II:560–673, 2000.
- [EH99] J. Etnyre and K. Honda, On the non-existence of tight contact structures. preprint GT/9910115.
- [El67] H. Eliasson, Geometry of manifolds of maps. *J. Diff. Geom.*, 1:169–194, 1967.
- [F88] A. Floer, The unregularised gradient flow of the symplectic action, *Comm. Pure Appl. Math.*, 41:775–813, 1988.
- [Fr92] J. Franks, Geodesics on S^2 and periodic points of annulus homeomorphisms. *Inv. Math.*, 108:403–418, 1992.
- [Ge03] H. Geiges, Contact Geometry. In *Handbook of Differential Geometry*, vol. 2, to appear.
- [Gr85] M. Gromov, Pseudoholomorphic curves in symplectic manifolds, *Invent. Math.*, 82:307–347, 1985.
- [H93] H. Hofer, Pseudoholomorphic curves in symplectisations with application to the Weinstein conjecture in dimension three. *Invent. Math.*, 114:515–563, 1993.
- [H00] H. Hofer, Holomorphic curves and real three-dimensional dynamics. *Geom. Funct. Anal.*, Special Volume, Part II, 674–704, 2000.
- [HK96] H. Hofer and M. Kriener, Holomorphic curves in contact dynamics. In *Proceedings of the Conference on Differential Equations Marking the 70th Birthday of Peter Lax and Louis Nirenberg*, Volume 65, pp. 77-131, 1999.

- [HLS97] H. Hofer, V. Lizan and J. C. Sikorav, On genericity for holomorphic curves in 4-dimensional almost complex manifolds. *J. Geometric Analysis*, Volume 7, No. 1, pp. 149-160, 1997.
- [Hm97] C. Hummel, *Gromov's Compactness Theorem for Pseudoholomorphic Curves*. Birkhäuser, 1997.
- [Ho00] K. Honda, On the classification of tight contact structures I. *Geometry & Topology*, 4:309–368, 2000.
- [Hu02] M. Hutchings, An index inequality for embedded pseudoholomorphic curves in symplectizations. *J. Eur. Math. Soc.*, 4:313–361, 2002.
- [HWZ95a] H. Hofer, K. Wysocki and E. Zehnder, Properties of pseudoholomorphic curves in symplectisations II: Embedding controls and algebraic invariants. *Geometrical and Functional Analysis*, Vol. 5, No. 2., pp. 270-328, 1995.
- [HWZ95b] H. Hofer, K. Wysocki and E. Zehnder, A Characterisation of the tight Three-Sphere. *Duke Math. J.* 81 (1):159-226, 1995.
- [HWZ96a] H. Hofer, K. Wysocki and E. Zehnder, Properties of pseudoholomorphic curves in symplectisations I: Asymptotics. *Ann. I. H. P. Analyse Non Linéaire*, 13:337–379, 1996.
- [HWZ96b] H. Hofer, K. Wysocki and E. Zehnder, Properties of pseudoholomorphic curves in symplectisations IV: Asymptotics with degeneracies. In *Contact and Symplectic Geometry*, edited by C. Thomas, pp. 78-117. Publications of the Newton Institute, Vol. 8, Cambridge University Press, 1996.
- [HWZ98] H. Hofer, K. Wysocki and E. Zehnder, The dynamics on a strictly convex energy surface in \mathbb{R}^4 . *Annals of Mathematics*, 148, pp. 197–289, 1998.
- [HWZ99] H. Hofer, K. Wysocki and E. Zehnder, Properties of pseudoholomorphic curves in symplectisations III: Fredholm theory. In *Topics in Nonlinear Analysis*, Progr. Nonlinear Anal. and Their Appli. vol. 35, Birkhäuser, 1999.
- [HWZ03a] H. Hofer, K. Wysocki and E. Zehnder, Finite energy cylinders of small area. *Ergodic Theory Dynam. Systems*, 22, no. 5, pp. 1451–1486, 2002.
- [HWZ03b] H. Hofer, K. Wysocki and E. Zehnder, Finite energy foliations of tight three-spheres and Hamiltonian dynamics. *Annals of Mathematics*, 157:125–255, 2003.

- [HZ94] H. Hofer and E. Zehnder, *Symplectic Invariants and Hamiltonian Dynamics*, Birkhäuser, 1994.
- [Kr98] M. Kriener, *An Intersection Formula for Finite Energy Half Cylinders*. PhD Thesis, ETH-Zürich, 1998.
- [K98] P. Kronheimer, Embedded surfaces and gauge theory in three and four dimensions. In *Surveys in Differential Geometry, Vol. III*, pp. 243–298, International Press, 1998.
- [KMOS03] P. Kronheimer, T. Mrowka, P. Ozsváth and Z. Szabó, Monopoles and Lens space surgeries. preprint GT/0310164.
- [La93] S. Lang, *Real and Functional Analysis*, Springer, 1993.
- [Li62] W. B. R. Lickorish, A representation of orientable combinatorial 3-manifolds. *Annals of Mathematics (2)*, 76:531–540, 1962.
- [Lu71] R. Lutz, *Sur quelques propriétés des formes différentielles en dimension trois*. PhD thesis, Strasbourg, 1971.
- [Ma71] J. Martinet, Formes de contact sur les variétés de dimension 3. In *Proc. Liverpool Singularities Sympos. II*, Lecture Notes in Math. 209:142–163, Springer, Berlin, 1971.
- [Mi63] J. Milnor, *Morse Theory*. Princeton University Press, 1963.
- [MS98] D. McDuff and D. Salamon, *Introduction to symplectic topology*, second edition, Oxford University Press, 1998.
- [MS04] D. McDuff and D. Salamon, *J-holomorphic Curves and Symplectic Topology*. AMS, Providence, 2004.
- [OS02] P. Ozsváth and Z. Szabó, Heegaard Floer homologies and contact structures. preprint SG/0210127.
- [PS] V. V. Prasolov, A. B. Sossinsky, *Knots, Links, Braids and 3-Manifolds*, AMS, Providence, 1997.
- [S97] D. Salamon, Lectures on Floer homology. In *Symplectic Geometry and Topology*, edited by Y. Eliashberg and L. Traynor, IAS/Park City Mathematics series, Vol 7, 1999, pp. 143–230.
- [Sa99] N. Saveliev, *Lectures on the Topology of 3-Manifolds*, de Gruyter, 1999.

- [Sch96] M. Schwarz, *Cohomology Operations from S^1 -Cobordisms in Floer Homology*. PhD Thesis, ETH-Zürich, 1996.
- [SS92] M. Seppälä and T. Sorvali, *Geometry of Riemann Surfaces and Teichmüller Spaces*, North-Holland Mathematics Studies, 1992.
- [Sf05] R. Siefring, PhD Thesis, NYU, in preparation.
- [T02] C. Taubes, A compendium of pseudoholomorphic beasts in $\mathbb{R} \times (S^1 \times S^2)$. *Geom. Topol.*, 6:657–814, 2002.
- [V04] V. S. Varadarajan, *Supersymmetry for Mathematicians: An Introduction*, Courant Lecture Notes in Mathematics, AMS, 2004.
- [Wa60] A. H. Wallace, Modifications and cobounding manifolds. *Canad. J. Math.*, 12:503–528, 1960.
- [Wd79] W. L. Wendland, *Elliptic Systems in the Plane*, Pitman, 1979.
- [Y98] R. Ye, Filling by holomorphic curves in symplectic 4-manifolds. *Trans. Amer. Math. Soc.*, 350 (1998), 213–250.