

MSci PROJECT IN MATHEMATICS

**COMPLEX COBORDISM AND
ALMOST COMPLEX FILLINGS OF
CONTACT MANIFOLDS**

November 2, 2016

Naomi L. Kraushar

supervised by
Dr C Wendl

University College London

Abstract

An important problem in contact and symplectic topology is the question of which contact manifolds are symplectically fillable, in other words, which contact manifolds are the boundaries of symplectic manifolds, such that the symplectic structure is consistent, in some sense, with the given contact structure on the boundary. The homotopy data on the tangent bundles involved in this question is finding an almost complex filling of almost contact manifolds. It is known that such fillings exist, so that there are no obstructions on the tangent bundles to the existence of symplectic fillings of contact manifolds; however, so far a formal proof of this fact has not been written down. In this paper, we prove this statement. We use cobordism theory to deal with the stable part of the homotopy obstruction, and then use obstruction theory, and a variant on surgery theory known as contact surgery, to deal with the unstable part of the obstruction.

Contents

1	Introduction	2
2	Vector spaces and vector bundles	4
2.1	Complex vector spaces	4
2.2	Symplectic vector spaces	7
2.3	Vector bundles	13
3	Contact manifolds	19
3.1	Contact manifolds	19
3.2	Submanifolds of contact manifolds	23
3.3	Complex, almost complex, and stably complex manifolds	25
4	Universal bundles and classifying spaces	30
4.1	Universal bundles	30
4.2	Universal bundles for $O(n)$ and $U(n)$	33
4.3	Stable vector bundles	37
5	Cobordism and the Thom-Pontrjagin Theorem	40
5.1	Manifolds with (B, f) structure	40
5.2	Cobordism groups	43
5.3	Thom spaces	47
6	Obstruction theory	52
6.1	Problems of obstruction theory	52
6.2	Applying obstruction theory	54
7	Contact Surgery	59
7.1	Surgery	59
7.2	Symplectic cobordism	65
7.3	Contact surgery	69
7.4	Applying contact surgery	74

Chapter 1

Introduction

Contact and symplectic topology involve manifolds equipped with differential forms with particular properties. These manifolds arose in Hamiltonian mechanics, and have wide applications in physics. Symplectic topology is the study of symplectic manifolds, which are manifolds of even dimension equipped with a symplectic form, that is, a closed nondegenerate differential 2-form. Contact topology is, in a sense, the odd-dimensional analogue of symplectic topology. It is the study of contact manifolds, which are manifolds equipped with a contact structure, which is a subbundle of the tangent bundle that is the kernel of a contact form. A contact form is a 1-form α such that $d\alpha$ is a symplectic form on the kernel of α . We define contact manifolds formally in Section 3.1, and symplectic manifolds in Section 7.2.

If we have a contact manifold M of dimension $2n - 1$, a question we can ask is: can we find a symplectic manifold W of dimension $2n$, such that its boundary is M , and the symplectic structure is consistent, in some sense, with the contact structure on the boundary? We call such a manifold W a symplectic filling of M , which can be a strong or weak filling.

To show that this question could have a positive answer, we look at the structures induced on the tangent bundles of contact and symplectic manifolds. We begin in Chapter 2 by explaining complex and symplectic linear algebra, which will allow us to understand these structures on the fibres of these tangent bundles, which are vector spaces. We then give a brief account of fibre bundles, which allows us to define vector bundles, with additional structures imposed smoothly on their fibres, especially the complex and symplectic structures we look at in Sections 2.1 and 2.2.

In Chapter 3, we define contact manifolds, and explain the almost con-

tact structure induced on their tangent bundles by the contact structure. An almost contact structure is not quite the same as a complex vector bundle structure on the tangent bundle, since the tangent bundle has odd rank. Instead, it is a complex structure on a subbundle of the tangent bundle, such that the tangent bundle consists of this complex subbundle plus a trivial line bundle. We then define complex and almost complex manifolds, where an almost complex manifold is a manifold with a complex structure on its tangent bundle. Finally, we define stably complex manifolds, which are generalisations of almost complex manifolds, and we show that almost contact manifolds are stably complex.

We then develop the theory of universal bundles in Chapter 4, which gives us a bijection between vector bundles, up to isomorphism, and homotopy classes of maps into spaces known as classifying spaces. Additional structures imposed on vector bundles, such as the almost contact and almost complex structures defined in Chapter 3, are equivalent to liftings of these maps from one classifying space to another, which we explain in detail. This enables us to describe structures on the tangent bundle of a manifold, such as almost contact and almost complex structures, as homotopy-theoretic data associated with manifolds. We construct universal bundles for the specific structures that we need. We also develop the theory of stable vector bundles so that we can classify the homotopy data associated with the stable tangent bundles of manifolds, which are the key to cobordism theory.

The homotopy obstruction to symplectic fillings of contact manifolds is an almost complex filling, which is an almost manifold W , whose boundary is M , such that the complex structure on the tangent bundle of W induces the almost contact structure at the boundary of M . Cobordism theory, which we develop in Chapter 5, gives a partial answer to the question of whether such fillings exist. However, the filling that we find is a stable complex filling of the almost contact structure, which is a weaker result than we need.

In Chapter 6, we show that we can reduce the stable complex filling to an almost complex manifold, and moreover, this manifold is an almost complex filling of an almost contact structure on M that is homotopic to the original structure outside of some embedded disc of the same dimension M , seen as a CW-complex. Finally, in Chapter 7, we define contact surgery, which is a variant of surgery theory, and use this, and the closely related notion of symplectic handle attachment, to change the homotopy data in a suitably chosen embedded disc in M of the same dimension as M to obtain an almost complex filling of M .

Chapter 2

Vector spaces and vector bundles

Much of this project will deal with vector bundles, specifically, tangent bundles of manifolds, with some additional structure. We begin by describing additional structures that can be defined on real vector spaces.

2.1 Complex vector spaces

Definition 2.1.1. Let V be a real vector space. A *linear complex structure*, or more simply, a *complex structure* on V is a linear map $J : V \rightarrow V$ satisfying $J^2 = -I$; equivalently, J is a matrix in $GL(V)$ such that $J^2 = -I$.

We call the pair (V, J) a *complex vector space*.

Only even dimensional spaces admit almost complex structures, as we have $\det(J)^2 = (-1)^{\dim V}$, and J is a linear map of real spaces, so $\det(J)$ must be real, hence $\dim V$ must be even. In particular, since $J^2 = -1$, we can use J to define multiplication by complex scalars: for $v \in V$, let $iv = Jv$, so that $(x + iy)v = xv + yJv$. Hence the map J gives V the structure of a complex vector space, justifying the definition. This must have complex dimension $\dim_{\mathbb{C}} V = \frac{1}{2} \dim_{\mathbb{R}} V$, as \mathbb{C} is a 2-dimensional real vector space.

Proposition 2.1.2. *Every even-dimensional real space admits a complex structure.*

Proof. We can define a linear map $J_0 : \mathbb{R}^{2n} \rightarrow \mathbb{R}^{2n}$ by the $2n \times 2n$ matrix $J_0 = \begin{pmatrix} 0 & I_n \\ -I_n & 0 \end{pmatrix}$ which satisfies $J_0^2 = -I_{2n}$, so that J defines a linear complex

structure on \mathbb{R}^{2n} . Hence every even-dimensional real vector space $V \cong \mathbb{R}^{2n}$ admits a linear complex structure. \square

We call this complex structure J_0 the *standard complex structure* on \mathbb{R}^{2n} . The real vector space \mathbb{R}^{2n} with basis $\{e_1, \dots, e_n, -e_{n+1}, -e_{2n}\}$, where $\{e_j\}_{j \leq 2n}$ is the standard basis, becomes a complex vector space with basis $\{e_1, \dots, e_n\}$, since $ie_j = J_0 e_j = -e_{n+j}$ for $1 \leq j \leq n$. This makes it easy to see how complex conjugates work. Let $v \in \mathbb{R}^{2n}$ such that $v = \sum_{j=1}^{2n} v_j e_j$. Then we have

$$\bar{v} = \overline{\sum_{j=1}^{2n} v_j e_j} = \sum_{j=1}^n v_j e_j - \sum_{j=n+1}^{2n} v_j e_j.$$

We can construct a similar basis for any complex structure J .

Proposition 2.1.3. *Let J be a complex structure on \mathbb{R}^{2n} . Then we can find a basis $\{b_1, \dots, b_n, c_1, \dots, c_n\}$ such that $Jb_j = c_j$.*

Proof. Start with any nonzero vector $b_1 \in \mathbb{R}^{2n}$, and let $c_1 = Jb_1$. Clearly these two vectors are linearly independent over \mathbb{R} , as if $c_1 = \lambda b_1$ for some $\lambda \in \mathbb{R}$, we have $\lambda^2 = -1$, which is impossible. Hence $\text{span}\{b_1, c_1\}$ is a 2-dimensional subspace of \mathbb{R}^{2n} . Choose $b_2 \notin \text{span}\{b_1, c_1\}$. As above, $Jb_1 \notin \text{span}\{b_1\}$. We also have $Jb_2 \notin \text{span}\{b_1, c_1\}$, since if $Jb_2 = \lambda b_1 + \mu c_1$, then $b_2 = J^4 b_2 = J^3(Tb_2) = J^3(\lambda b_1 + \mu c_1) = (-\lambda c_1 + \mu b_1)$, using $J^2 = -I$. Hence we now have four linearly independent vectors $\{b_1, b_2, c_1, c_2\}$. Repeating this process gives a basis $\{b_1, \dots, b_n, c_1, \dots, c_n\}$ such that $Jb_j = c_j$. We call this basis a *complex basis* of (\mathbb{R}^{2n}, J) , since $\{b_1, \dots, b_n\}$ is a basis for (\mathbb{R}^{2n}, J) over \mathbb{C} , using $ib_j = c_j$. \square

We can define the automorphism group of real spaces with complex structure.

Definition 2.1.4. Let \mathbb{R}^{2n} be equipped with the standard complex structure J_0 . We define the *complex general linear group* of \mathbb{R}^{2n} to be the group of invertible matrices that commute with J_0 and denote this group $GL(n, \mathbb{C})$.

The correspondence between multiplication by J_0 over \mathbb{R} and multiplication by i over \mathbb{C} means that this group can easily be identified with the usual definition of the general linear group $GL(n, \mathbb{C})$ of \mathbb{C}^n . We have therefore described $GL(n, \mathbb{C})$ as a subgroup of $GL(2n, \mathbb{R})$. We could define the group with respect to any choice of complex structure, but these can all be

identified with $GL(n, \mathbb{C})$ in the same way, so all of these general linear groups would be homeomorphic.

Proposition 2.1.5. *The space $\mathcal{J}_n = \{J \in GL(2n, \mathbb{R}) : J^2 = -I\}$ of complex structures on \mathbb{R}^{2n} , with the subspace topology, is homeomorphic to $GL(2n, \mathbb{R})/GL(n, \mathbb{C})$ with the quotient topology.*

Proof. The group $GL(n, \mathbb{R})$ acts on the space of complex structures \mathcal{J}_n by conjugation, so for a complex structure $J \in \mathcal{J}_n$ and a matrix $A \in GL(2n, \mathbb{R})$, we have the action $GL(2n, \mathbb{R}) \times \mathcal{J}_n \rightarrow \mathcal{J}_n, (A, J) \rightarrow AJA^{-1}$. Since we can define a complex basis with respect to any given complex structure, this action is also transitive, since we can find a matrix in $GL(2n, \mathbb{R})$ that maps one such basis to another by conjugation, making \mathcal{J}_n a homogeneous space. The stabiliser group of this action is the set of matrices, for some $J \in \mathcal{J}_n$, such that $AJA^{-1} = J$, which is, by definition, homeomorphic to $GL(n, \mathbb{C})$. Hence \mathcal{J}_n is homeomorphic to $GL(2n, \mathbb{R})/GL(n, \mathbb{C})$. \square

Suppose that $A \in GL(n, \mathbb{C}) \subset GL(2n, \mathbb{R})$. Let $A = \begin{pmatrix} A_{11} & A_{12} \\ A_{21} & A_{22} \end{pmatrix}$, where the A_{jk} are $n \times n$ matrices. We have $AJ_0 = J_0A$, so

$$\begin{aligned} \begin{pmatrix} A_{11} & A_{12} \\ A_{21} & A_{22} \end{pmatrix} \begin{pmatrix} 0 & I_n \\ -I_n & 0 \end{pmatrix} &= \begin{pmatrix} 0 & I_n \\ -I_n & 0 \end{pmatrix} \begin{pmatrix} A_{11} & A_{12} \\ A_{21} & A_{22} \end{pmatrix} \\ \Rightarrow \begin{pmatrix} -A_{12} & A_{11} \\ -A_{22} & A_{21} \end{pmatrix} &= \begin{pmatrix} A_{21} & A_{22} \\ -A_{11} & -A_{12} \end{pmatrix} \\ \Rightarrow A &= \begin{pmatrix} A_{11} & A_{12} \\ -A_{12} & A_{11} \end{pmatrix}. \end{aligned}$$

This allows us to write $A = A_{11} + iA_{12}$ in the complex basis, since $ie_j = -e_{j+n}$, so we can define the conjugate of A , $\bar{A} = A_{11} - iA_{12}$ in the complex basis, which gives $\bar{A} = \begin{pmatrix} A_{11} & -A_{12} \\ A_{12} & A_{11} \end{pmatrix}$ in the real basis, and the conjugate transpose, $A^\dagger = \bar{A}^T = (A_{11} - iA_{12})^T$ in the complex basis, which gives $A^\dagger = \begin{pmatrix} A_{11}^T & -A_{12}^T \\ A_{12}^T & A_{11}^T \end{pmatrix}$ in the real basis.

Definition 2.1.6. A matrix $A \in GL(n, \mathbb{C})$ is called *unitary* if $A^\dagger = A^{-1}$.

Clearly, the set of all such matrices forms a group, which is called the *unitary group* and denoted $U(n)$.

We can identify this with the usual definition of the unitary group over \mathbb{C} by identifying the real matrix $A = \begin{pmatrix} A_{11} & A_{12} \\ -A_{12} & A_{11} \end{pmatrix}$ with the complex matrix $A_{11} + iA_{21}$ as above.

The final point to note is that for $A \in GL(n, \mathbb{C}) \subset GL(2n, \mathbb{R})$, we have

$$A^\dagger = \begin{pmatrix} A_{11} & A_{12} \\ -A_{12} & A_{11} \end{pmatrix}^\dagger = \begin{pmatrix} A_{11}^T & -A_{12}^T \\ A_{12}^T & A_{11}^T \end{pmatrix} = \begin{pmatrix} A_{11} & A_{12} \\ -A_{12} & A_{11} \end{pmatrix}^T = A^T.$$

Hence $A \in GL(n, \mathbb{C})$ is unitary if and only if $A \in GL(2n, \mathbb{R})$ is orthogonal. This gives $U(n) = O(2n) \cap GL(n, \mathbb{C}) \subset GL(n, \mathbb{R})$.

2.2 Symplectic vector spaces

Definition 2.2.1. Let V be a vector space over a field \mathbb{F} . A *symplectic form* on V is a bilinear form $\omega : V \times V \rightarrow \mathbb{F}$ that is

1. *alternating*, that is, $\omega(v, v) = 0$ for $v \in V$,
2. *nondegenerate*, that is, $\omega(u, v) = 0$ for all $v \in V$ implies that $u = 0$.

We call the pair (V, ω) a *symplectic vector space*.

Note that we have $0 = \omega(u + v, u + v) = \omega(u, u) + \omega(v, v) + \omega(u, v) + \omega(v, u) = \omega(u, v) + \omega(v, u)$, so that $\omega(u, v) = -\omega(v, u)$, so that an alternating form is skew-symmetric. If the field has characteristic not equal to 2, then $\omega(u, v) = \omega(v, u) \Rightarrow \omega(v, v) = -\omega(v, v) \Rightarrow \omega(v, v) = 0$, so that skew-symmetric forms are alternating. In particular, over \mathbb{R} , the alternating condition on ω is equivalent to a skew-symmetry condition.

Definition 2.2.2. The *standard symplectic form* on \mathbb{F}^{2n} with co-ordinates $(x_1, \dots, x_n, y_1, \dots, y_n)$ is

$$\omega_0 = \sum_{j=1}^{2n} dx_j \wedge dy_j.$$

With respect to a fixed basis, every bilinear form α can be represented as uniquely as a matrix Ω such that $\alpha(u, v) = u^T \Omega v$. The conditions on ω means that Ω must be skew-symmetric and invertible. Hence if V is finite-dimensional, its dimension must be even, as an odd dimensional skew-symmetric matrix is singular. In particular, using the standard basis for \mathbb{F}^{2n} ,

the standard symplectic structure ω_0 can be defined by $\omega(u, v) = u^T J_0 v$, where $J_0 = \begin{pmatrix} 0 & I_n \\ -I_n & 0 \end{pmatrix}$ as in Section 2.1.

As for real vector spaces with complex structure, we can define the automorphism group of symplectic vector spaces.

Definition 2.2.3. Let \mathbb{F} be a field, and let \mathbb{F}^{2n} be equipped with the standard symplectic structure ω_0 . We define the *symplectic group* of this space to be the set of invertible matrices A such that $\omega_0(Au, Av) = \omega_0(u, v)$ for all $u, v \in V$ and denote this group $Sp(2n, \mathbb{F})$.

The condition means that $(Au)^T J_0 (Av) = u^T J_0 v$ for all u, v , which is equivalent to $u(A^T J_0 A)v = u J_0 v$ for all u, v , so that $Sp(2n, \mathbb{F}) = \{A \in GL(2n, \mathbb{F}) : A^T J_0 A = J_0\}$. We could define a similar group for any symplectic structure, but all such groups can be identified with each other via their defining matrices, as in the case of different complex structures.

This group is not to be confused with the symplectic group $Sp(n) \subset GL(n, \mathbb{H})$, the quaternionic analogue of the orthogonal and unitary groups over \mathbb{R} and \mathbb{C} respectively, which is compact. When there is a possibility of confusion, we refer to $Sp(2n, \mathbb{R})$ as the real symplectic linear group, and $Sp(n)$ as the compact symplectic group. The notation and language used in the literature to refer to these different symplectic groups varies.

We can derive an important property of the unitary group $U(n)$ from this definition. We have the following subgroups of $GL(2n, \mathbb{R})$ with their defining equations:

1. the *orthogonal group* $O(2n)$ with equation $A^T A = I_{2n}$;
2. the *complex linear group* $GL(n, \mathbb{C})$ with equation $A J_0 = J_0 A$;
3. the *symplectic group* $Sp(2n, \mathbb{R})$ with equation $A^T J_0 A = J_0$;

and from Section 2.1, we have $O(2n) \cap GL(n, \mathbb{C}) = U(n)$. Any two of the three equations above imply the third, so this gives us

$$O(2n) \cap GL(n, \mathbb{C}) = O(2n) \cap Sp(2n, \mathbb{R}) = GL(n, \mathbb{C}) \cap Sp(2n, \mathbb{R}) = U(n).$$

This is known as the *2-out-of-3 property* of the unitary group.

From this point, all symplectic vector spaces are assumed to be real finite-dimensional vector spaces.

Definition 2.2.4. Let U be a subspace of the symplectic vector space (V, ω) .

We define the *symplectic complement* of U , $U^\omega = \{v \in V : \omega(u, v) = 0 \text{ for all } u \in U\}$.

Proposition 2.2.5. For a subspace U of (V, ω) , U^ω is also a subspace of V , and $\dim U + \dim U^\omega = \dim V$.

Proof. Let $\omega(v, -)$ represent the 1-form on V where $\omega(v, -)(w) = \omega(v, w)$. Since ω is nondegenerate, the the map

$$\begin{aligned} \phi : V &\rightarrow V^* \\ v &\mapsto \omega(v, -) \end{aligned}$$

is an isomorphism, where V^* is the dual of V . Define a related linear map,

$$\begin{aligned} \phi_U : V &\rightarrow U^* \\ v &\mapsto \omega(v, -)|_U. \end{aligned}$$

By definition, the kernel of this map is U^ω , which is therefore a subspace of V .

Let $\alpha \in U^*$ be a linear form on U . Extend this to a form $\tilde{\alpha} \in V^*$ on $V \supset U$. By surjectivity of the map $v \rightarrow \omega(v, *)$, there exists a $v \in V$ such that $\tilde{\alpha} = \omega(v, -)$. Now we have $\phi_U(v) = \phi(v)|_U = \tilde{\alpha}(v)|_U = \alpha$, so that ϕ_U is surjective.

We know that $\dim U^* = \dim U$, so we can apply the kernel-rank theorem to get $\dim U^\omega + \dim U = \dim V$. \square

Corollary 2.2.5.1. For a subspace U of (V, ω) , we have $(U^\omega)^\omega = U$.

Proof. By definition, if $u \in U$, then $\omega(u, v) = 0$ for all $v \in U^\omega$, so that $u \in (U^\omega)^\omega$. Hence $U \subset (U^\omega)^\omega$. By the lemma, $\dim U = \dim(U^\omega)^\omega$. Hence $(U^\omega)^\omega = U$. \square

Definition 2.2.6. Let U be a subspace of (V, ω) . We say that U is

- *symplectic* if $U \cap U^\omega = \{0\}$,
- *isotropic* if $U \subset U^\omega$,
- *coisotropic* if $U \supset U^\omega$,
- *Lagrangian* if $U = U^\omega$.

We have the following properties of a subspace U of a symplectic vector space (V, ω) :

- Proposition 2.2.7.** 1. U is a symplectic subspace if and only if the restriction $\omega|_U$ of ω to U is a symplectic form on U, U^ω .
2. U is isotropic if and only if U^ω is coisotropic.
3. If U is Lagrangian, $\dim U = \frac{1}{2} \dim V$.
4. If U is isotropic, ω defines a symplectic form on U^ω/U .

- Proof.* 1. The condition $U \cap U^\omega = 0$ is equivalent to saying the restriction $\omega|_U$ of ω to U is nondegenerate. Hence ω restricts to a symplectic form $\omega|_U$ on U , hence the term symplectic subspace. Using $(U^\omega)^\omega = U$, we have $\omega|_{U^\omega}$ a symplectic form on U^ω as well.
2. The fact that $(U^\omega)^\omega = U$ means that U is isotropic if and only if U^ω is coisotropic and vice versa.
3. The fact that $\dim U + \dim U^\omega = \dim V$ means that if U is a Lagrangian subspace of (V, ω) , we have $\dim U + \dim U = \dim V$, so that $\dim U = \frac{1}{2} \dim V$.
4. Suppose U is isotropic, so that $U \subset U^\omega$. Let $v_1, v_2 \in U^\omega$, and $u_1, u_2 \in U \subset U^\omega$. Then $\omega(v_1 + u_1, v_2 + u_2) = \omega(v_1, v_2)$ since all other terms in the expansion vanish, as $u_1, u_2 \in U, u_1, u_2, v_1, v_2 \in U^\omega$. Hence ω is a well defined bilinear form on U^ω/U . The form will be alternating, since it is alternating on V . If there exists some $v_0 \in U^\omega$ such that $\omega(v_0, v) = 0$ for all $v \in U^\omega$, by definition, this means that $v_0 \in (U^\omega)^\omega$, which means that $v_0 \in U$, so that $[v_0] = [0]$ in U^ω/U . Hence the form is nondegenerate, so the form is symplectic. □

We can use the first part of this proposition to define symplectic bases as we defined complex bases in Section 2.1.

Proposition 2.2.8. *Let (V, ω) be a symplectic space. There exists a basis $\{e_1, \dots, e_n, f_1, \dots, f_n\}$ such that symplectic form ω can be written as*

$$\omega = \sum_{j=1}^n e_j^* \wedge f_j^*,$$

where $*$ denotes the dual of a vector.

Proof. Suppose that V has dimension $2n$. Let e_1 be any nonzero vector. Since ω is nondegenerate, we can find f_1 such that $\omega(e_1, f_1) \neq 0$; by rescaling, we can choose f_1 such that $\omega(e_1, f_1) = 1$. We then have that ω is a symplectic form on $\text{span}\{b_1, c_1\}$, so that $\text{span}\{b_1, c_1\}$ is a symplectic subspace, by the first part of Proposition 2.2.7, so that $\text{span}\{b_1, c_1\}^\omega$ is also a symplectic subspace, using $(U^\omega)^\omega = U$.

We can therefore apply this process repeatedly to obtain a basis $\{e_1, \dots, e_n, f_1, \dots, f_n\}$ such that $\omega(e_i, f_i) = 1$ by construction, $\omega(e_i, e_i), \omega(f_i, f_i) = 0$ since ω is alternating, and if $i \neq j$, we have $\omega(e_i, f_j) = 0$, since $f_j \in \text{span}\{e_i\}^\omega$. These conditions completely describe the form ω , and also the form $\sum_{j=1}^n e_j^* \wedge f_j^*$, so these two forms must be equal.

We call the basis $\{e_1, \dots, e_n, f_1, \dots, f_n\}$ a *symplectic basis* for (V, ω) . \square

Note that this proof also explicitly constructs a Lagrangian subspace of V , namely $\text{span}\{e_1, \dots, e_n\}$. Note also that the standard symplectic form on \mathbb{R}^{2n} with co-ordinates $(x_1, \dots, x_n, y_1, \dots, y_n)$ is of this form, since

$$\omega_0 = \sum_{j=1}^n dx_j \wedge dy_j = \sum_{j=1}^n e_j^* \wedge e_{j+n}^*,$$

where $\{e_1, \dots, e_{2n}\}$ is the standard basis for \mathbb{R}^{2n} , so the standard basis is also a symplectic basis for $(\mathbb{R}^{2n}, \omega_0)$.

Proposition 2.2.9. *A skew-symmetric bilinear form ω on a real vector space V of dimension $2n$ is a symplectic form if and only if $\omega^n \neq 0$.*

Proof. Suppose that ω is a symplectic form on V . Let $(e_1, \dots, e_n, f_1, \dots, f_n)$ be a symplectic basis for (V, ω) . Then

$$\begin{aligned} \omega^n &= \left(\sum_{j=1}^n e_j^* \wedge f_j^* \right)^n \\ &= n! e_1^* \wedge f_1^* \wedge \dots \wedge e_n^* \wedge f_n^* \\ &\neq 0. \end{aligned}$$

Conversely, suppose that $\omega^n \neq 0$, and fix $u \neq 0$ in V . If $\omega(u, v) = 0$ for all $v \in V$, then $\omega^n(u, \dots) = 0$, which is a contradiction. So there exists some $w \in V$ such that $\omega(u, w) \neq 0$, so ω is nondegenerate and so is a symplectic form. \square

Symplectic bases also enable us to describe the space \mathcal{W}_{2n} of symplectic forms on $(\mathbb{R}^{2n}, \omega)$.

Proposition 2.2.10. *The space $\mathcal{W}_{2n} \cong \{\Omega \in GL(2n, \mathbb{R}) : \Omega^T = -\Omega\}$ of symplectic structures on $V \cong \mathbb{R}^{2n}$ is homeomorphic to $GL(2n, \mathbb{R})/Sp(2n, \mathbb{R})$ with the quotient topology.*

Proof. The group $GL(n, \mathbb{R})$ acts on the space of symplectic structures \mathcal{W}_{2n} by the action $GL(2n, \mathbb{R}) \times \mathcal{W}_{2n} \rightarrow \mathcal{W}_{2n}, (A, \omega)(u, v) \rightarrow \omega(Au, Av)$. Since we can define a symplectic basis with respect to any given symplectic form, this action is also transitive, so that \mathcal{W}_{2n} is a homogeneous space. The stabiliser group of this action is the set of matrices A such that $\omega(Au, Av) = \omega(u, v)$ for all $u, v \in \mathbb{R}^{2n}$, which is, by definition, homeomorphic to $Sp(2n, \mathbb{R})$. Hence \mathcal{W}_{2n} is homeomorphic to $GL(2n, \mathbb{R})/Sp(2n, \mathbb{R})$. \square

We now move on to complex structures on symplectic vector spaces.

Definition 2.2.11. Let (V, ω) be a symplectic vector space, J a complex structure on V . We say that J *tames* ω if $\omega(v, Jv) > 0$ for all nonzero $v \in V$.

We say that J is *compatible* with ω if J tames ω , and $\omega(Ju, Jv) = \omega(u, v)$ for all $u, v \in V$.

Proposition 2.2.12. *Let (V, ω) be a $(2n)$ -dimensional symplectic vector space with a compatible complex structure J . Then there exists a symplectic basis that is also a complex basis, that is, a basis $\{e_1, \dots, e_n, f_1, \dots, f_n\}$ such that $Je_j = f_j$, and $\omega = \sum_{j=1}^n e_j^* \wedge f_j^*$.*

Proof. Let $\{b_1, \dots, b_n, c_1, \dots, c_n\}$ be a symplectic basis. The span of the first n vectors is a Lagrangian subspace, which we call L . Since J is compatible with ω , $\omega(v, Jv) > 0$ for all $v \in V$, so that for all $v \in L$, $Jv \notin L^\omega$, so $Jv \notin L$, since L is a Lagrangian subspace. Hence $L \cap JL = 0$, and since J is invertible, we have $\dim JL = \dim L = n$, so that $L \oplus JL = V$. In particular, since J is invertible, we have $\{Jb_1, \dots, Jb_n\}$ as a basis for JL . Now $\omega(b_j, Jb_j) > 0$, so let $e_j = \frac{1}{\omega(b_j, Jb_j)^{1/2}} b_j, f_j = Je_j$, then we have $\omega(e_j, f_j) = 1$, while all other possible pairs give $\omega = 0$, so we have a basis of the required form. We call such a basis a *complex symplectic basis*. \square

Proposition 2.2.13. *Let (V, ω) be a symplectic vector space. The space \mathcal{J}_ω of complex structures compatible with ω is homeomorphic to $Sp(2n, \mathbb{R})/U(n)$.*

Proof. The group $Sp(2n, \mathbb{R})$ acts on \mathcal{J}_ω via conjugation, so for a matrix $A \in Sp(2n, \mathbb{R})$ and a compatible complex structure $J \in \mathcal{J}_\omega$, we have $(A, J) \mapsto AJA^{-1}$. Since we can define a complex symplectic basis for (V, ω) with any compatible complex structure J , this action is transitive. The stabiliser group of this action is the set of matrices $A \in Sp(2n, \mathbb{R})$ such that $AJA^{-1} = J$, so $A \in GL(n, \mathbb{C})$, so this is the set $Sp(2n, \mathbb{R}) \cap GL(n, \mathbb{C}) = U(n)$. Hence \mathcal{J}_ω is homeomorphic to $Sp(2n, \mathbb{R})/U(n)$. \square

2.3 Vector bundles

We give a brief description of fibre bundles, which we will be using extensively. For a fuller treatment, see Steenrod.

Definition 2.3.1. Let $p : E \rightarrow B$ be a continuous surjective map, F another topological space. Suppose that for every $x \in E$, there exists an open neighbourhood U of $p(x) \in B$ and a homeomorphism $\phi : p^{-1}(U) \rightarrow U \times F$ such that p is equivalent to ϕ composed with the projection onto the first factor, $\pi^1 : U \times F \rightarrow U$, equivalently, such that the diagram

$$\begin{array}{ccc} p^{-1}(U) & \xrightarrow{\phi} & U \times F \\ \downarrow p & \swarrow \pi^1 & \\ U & & \end{array}$$

commutes. In this way, $p^{-1}(y)$ is homeomorphic to F for all $y \in B$. We call U a *local co-ordinate neighbourhood*, and (U, ϕ) a *local trivialisaton*, of $p : E \rightarrow B$ at $p(x)$. A set $\{(U_i, \phi_i)\}_{i \in J}$ of local trivialisations such that $\{U_i\}_{i \in J}$ covers B is called a *local trivialisaton* of the bundle. The quadruple (E, B, p, F) is called a *fibre bundle*.

The definition often given for a fibre bundle stops here, but we will need another important notion.

Suppose we have a topological group G acting on F , and the group action is compatible with local trivialisations. Formally, let $\{(U_i, \phi_i)\}$ be a local trivialisaton of the bundle such that the maps

$$\begin{aligned} \phi_i \circ \phi_j^{-1} : U_i \cap U_j \times F &\rightarrow U_i \cap U_j \times F \\ (x, \zeta) &\mapsto 0(x, \psi_{ij}(x)(\zeta)) \end{aligned}$$

define continuous maps $\psi_{ij} : U_i \cap U_j \rightarrow G$, called *transition maps*, satisfying

1. $\psi_{ii}(x) = 1_G$ for all $x \in U_i$,
2. $\psi_{ji}(x) = t_{ij}(x)^{-1}$ for all $x \in U_i \cap U_j$,
3. $\psi_{ij}(x)\psi_{jk}(x) = \psi_{ik}(x)$ for all $x \in U_i \cap U_j \cap U_k$.

We call the quintuple (E, B, p, F, G) a *fibre bundle with structure group G* , or *G -bundle*, with B the *base space*, E the *total space*, F the *fibre*, and G the *structure group* of the bundle.

We can define smooth fibre bundles in a similar way by specifying that all continuous maps must be smooth. For example, we have the notion of smooth fibre bundles over a smooth manifold.

We will often refer to the fibre bundle $\{E, B, p, F, G\}$ as $p : E \rightarrow B$, or $F \rightarrow E \rightarrow B$.

Definition 2.3.2. Let $p_1 : E_1 \rightarrow B_1, p_2 : E_2 \rightarrow B_2$ be fibre bundles. A pair of continuous maps $\phi : E_1 \rightarrow E_2, f : B_1 \rightarrow B_2$ is called a *bundle map* or *bundle morphism* if the diagram

$$\begin{array}{ccc} E_1 & \xrightarrow{\phi} & E_2 \\ \downarrow p_1 & & \downarrow p_2 \\ B_1 & \xrightarrow{f} & B_2 \end{array}$$

commutes.

If the bundles have the same base space $B = B_1 = B_2$, we require f to be the identity, so a bundle morphism $\phi : E_1 \rightarrow E_2$ is a map such that the diagram

$$\begin{array}{ccc} E_1 & \xrightarrow{\phi} & E_2 \\ & \searrow p_1 & \swarrow p_2 \\ & & B \end{array}$$

commutes. If ϕ is also a homeomorphism, so that it has an inverse that is also a bundle map, we say that ϕ is a *bundle isomorphism*.

Suppose in addition, these bundles have structure group G . If ϕ is G -equivariant, that is, $\phi(ge) = g\phi(e)$ for all $g \in G, e \in E_1$, then ϕ is a morphism of G -bundles, and we can define isomorphisms of G -bundles in a similar way.

Definition 2.3.3. A *section* s of a fibre bundle $p : E \rightarrow B$ is a map $s : B \rightarrow E$ such that $p \circ s = \text{id}_B$, in other words, a right inverse of p .

There is a construction of fibre bundles that will be useful later.

Definition 2.3.4. Let $p : E \rightarrow B$ be a fibre bundle, $f : X \rightarrow B$ a continuous map. We can define the *pullback bundle* $f^*E \rightarrow X$, with the same fibre, as follows. Let

$$f^*E = \{(x, e) \in X \times E : f(x) = p(e)\},$$

with the projection of the bundle $p' : f^*E \rightarrow X$ defined by projection onto the first factor, $p'(x, e) = x$. Projection onto the second factor gives a map $\pi^2 : f^*E \rightarrow E$, $\pi^2(x, e) = e$, such that the diagram

$$\begin{array}{ccc} f^*E & \xrightarrow{\pi^2} & E \\ \downarrow p' & & \downarrow p \\ X & \xrightarrow{f} & B \end{array}$$

commutes. In particular, the fibre of f^*E over x is just the fibre of E over $f(x)$.

We define some special cases of fibre bundles.

Definition 2.3.5. The simplest example of a fibre bundle is when $E = B \times F$. This is called the *trivial bundle* over B with fibre F .

Definition 2.3.6. A fibre bundle where the structure group is the same as the fibre, and acts on the fibre by the usual action of a group on itself, is called a *principal bundle*.

There is an important construction involving principal bundles.

Definition 2.3.7. Let $\{E, B, p, F, G\}$ be a fibre bundle. We define its *associated principal bundle*, to be the bundle with the same local co-ordinate neighbourhoods $U_i \subset B$ and the same transition maps $\psi_{ij} : U_i \cap U_j \rightarrow G$, and replace the fibre F by G and G acts on itself via these transition maps.

It is proven in [11] that two bundles with the same fibre are equivalent, that is, bundle isomorphic, if and only if their associated principal bundles are equivalent. The next special case of fibre bundles is one we will be using extensively.

Definition 2.3.8. A fibre bundle where the fibre is a vector space V , with the group of the bundle its general linear group $GL(V)$, is called a *vector bundle*. We can have vector bundles over different fields; the ones we will be most interested in are real and complex vector bundles.

The dimension of the fibre V is called the *rank* of the vector bundle. In particular, a vector bundle of rank 1 is called a *line bundle*.

Trivial vector bundles will be of significance later on, so, for a space B , we will denote the trivial vector bundle of real rank n , $B \times \mathbb{R}^n$, by $\underline{\mathbb{R}^n}$. We can perform some operations on vector bundles in the same way as we can perform them on vector spaces.

Definition 2.3.9. Let $E_1, E_2 \rightarrow X$ be vector bundles of rank n_1, n_2 respectively. We form the *Whitney sum* $E_1 \oplus E_2$ of these bundles by taking the direct sum of their fibres as vector spaces.

We can form the *dual* of a vector bundle by taking the fibres of the dual bundle to be the dual of the fibres of the vector bundle.

Example 2.3.10. An important example of a smooth vector bundle is the tangent bundle TM of a smooth manifold M ,

$$TM = \bigcup_{p \in M} T_p M, \quad \text{where } T_p M \text{ is the tangent space to } M \text{ at } p.$$

The local trivialisations of the tangent bundle are given via the local charts of M .

The dual bundle T^*M of the tangent bundle is called the *cotangent bundle*.

Note that by definition, sections of the tangent bundle are vector fields, and sections of the cotangent bundles are differential 1-forms.

We can define additional structures on real vector spaces, such as a metric or inner product, an orientation, a complex structure or symplectic structure. If we can define a structure on the fibres of a vector space for each point of the base space, such that the structures vary smoothly over the whole base space, we say that we have defined the structure on the vector bundle. In this way, we can define metrics, symplectic structures, or complex structures on vector bundles.

We know that imposing a metric on \mathbb{R}^n reduces its automorphism group from $GL(n, \mathbb{R})$ to $O(n)$, and imposing an orientation reduces the automorphism group from $GL(n, \mathbb{R})$ to $GL_+(n, \mathbb{R})$, the group of matrices with positive

determinant. We know from Section 2.1 that imposing a complex structure on \mathbb{R}^{2n} reduces the automorphism group from $GL(2n, \mathbb{R})$ to $GL(n, \mathbb{C})$ and, from Section 2.2, that defining a symplectic form on \mathbb{R}^{2n} reduces the automorphism group from $GL(2n, \mathbb{R})$ to $Sp(2n, \mathbb{R})$. We have an analogous construction for fibre bundles.

Definition 2.3.11. Let $p : E \rightarrow B$ be a G -bundle, and suppose that H is another topological group, and we have a group monomorphism $H \rightarrow G$. We compose the map $H \rightarrow G$ with the transition maps into H to define a G -bundle structure on H -bundles. A *reduction of the structure group* from G to H along the $H \rightarrow G$ is an isomorphism between the original G -bundle and a G bundle formed from an H -bundle via the map $H \rightarrow G$. If, instead of being a monomorphism, the map $H \rightarrow G$ is an epimorphism, we obtain a *lift of the structure group* in the same way.

Since $H \rightarrow G$ is a group monomorphism, H is isomorphic to its image, so the map is an inclusion $H \hookrightarrow G$. A reduction of the structure group from G to H along the inclusion $H \hookrightarrow G$ is simply a choice of trivialisation such that the transition maps take values in $H \subset G$.

Example 2.3.12. Suppose we have a vector bundle $p : E \rightarrow B$ of rank $2n$. A reduction of the structure group from $GL(2n, \mathbb{R})$ to $GL(n, \mathbb{C})$ is equivalent to imposing a complex structure on this bundle.

There are certain properties of Lie groups that we are going to need.

Lemma 2.3.13. 1. $GL(n, \mathbb{R})$ deformation retracts onto $O(n)$,

2. $GL(n, \mathbb{C})$ deformation retracts onto $U(n)$,

3. $Sp(2n, \mathbb{R})$ deformation retracts onto $U(n)$.

Proof. 1. Let $A \in GL(n, \mathbb{R})$. Since A is invertible, we can use the Gram-Schmidt process to find an orthonormal basis $\{e_1, \dots, e_n\}$ from the columns $\{a_1, \dots, a_n\}$ of A as follows:

$$b_i = a_i - \sum_{j < i} \frac{\langle a_i, b_j \rangle}{\langle b_j, b_j \rangle} b_j, \quad e_i = \frac{1}{\langle b_i, b_i \rangle} b_i.$$

By expressing the columns a_i in terms of this orthonormal basis, we have

$$a_i = \sum_{j \leq i} \langle a_j, e_j \rangle e_j.$$

In matrix form, this gives

$$A = (e_1 \ \dots \ e_n) \times \begin{pmatrix} \langle a_1, e_1 \rangle & \langle a_2, e_1 \rangle & \dots & \langle a_n, e_1 \rangle \\ 0 & \langle a_2, e_2 \rangle & \dots & \langle a_n, e_2 \rangle \\ \vdots & & & \vdots \\ 0 & \dots & 0 & \langle a_n, e_n \rangle \end{pmatrix}.$$

Hence we can find Q, R such that $A = QR$, where Q is an orthogonal matrix, and R is an upper triangular matrix. For simplicity, let $r_{ij} = \langle a_j, e_i \rangle$, so that $R = (r_{ij})$. We construct a deformation retraction of $GL(n, \mathbb{R})$ onto $O(n)$ by homotoping R to the identity matrix:

$$F_t(A) = Q \times \begin{pmatrix} t + (1-t)r_{11} & (1-t)r_{12} & \dots & (1-t)r_{n1} \\ 0 & t + (1-t)r_{22} & \dots & (1-t)r_{n2} \\ \vdots & & & \vdots \\ 0 & \dots & 0 & t + (1-t)r_{nn} \end{pmatrix}.$$

Clearly $F_0(A) = A$, $F_1(A) = Q$, and F_t preserves orthogonal matrices, since if $A \in O(n)$, then R is the identity. Moreover, the Gram-Schmidt process is a rational function of the entries of A , so that F_t is continuous. Hence F_t is a deformation retraction from $GL(n, \mathbb{R})$ onto $O(n)$.

2. This is exactly the same as above, except that in constructing Q and R , we use the Gram-Schmidt process with a Hermitian inner product, so that Q is unitary and R is upper triangular.
3. We have that $GL(2n, \mathbb{R})$ retracts onto $O(2n)$, so that $Sp(2n, \mathbb{R})$ retracts onto $Sp(2n, \mathbb{R}) \cap O(2n) = U(n)$.

□

We finish off with a lemma that we will be able to prove more easily once we have introduced classifying spaces.

Lemma 2.3.14. *A G -bundle admits a reduction of its structure group to $H \subset G$ if H is a deformation retract of G .*

For example, a real vector bundle may be viewed as having structure group $O(n)$, and a symplectic vector bundle may be viewed as having structure group $U(n)$, from Lemma 2.3.13.

Chapter 3

Contact manifolds

3.1 Contact manifolds

We begin with some basic definitions that will allow us to define contact manifolds.

Definition 3.1.1. Let M be a smooth real manifold of dimension n . Let p be a point in M , with T_pM the tangent space of M at p . A *contact element* ξ_p of M with contact point p is an $(n - 1)$ -dimensional subspace of T_pM .

Since ξ_p is an $(n - 1)$ -dimensional subspace of T_pM , which is itself an n -dimensional real vector space, ξ_p is the kernel of a linear functional $\alpha_p : T_pM \rightarrow \mathbb{R}$, which is unique up to multiplication by a nonzero scalar. By definition, α_p is a 1-form on T_pM .

Definition 3.1.2. Let M be a smooth real manifold of dimension n with tangent bundle TM . A *field of hyperplanes* or *hyperplane field* ξ on M is a smooth subbundle of TM of rank $n - 1$, equivalently, of corank 1.

For every $p \in M$, the fibre ξ_p of the hyperplane field ξ is a contact element. Using the local triviality of the bundle TM/ξ , we can see that ξ is locally the kernel of a 1-form α on TM .

Definition 3.1.3. Let $E \rightarrow M$ be a vector bundle of rank n , E' a subbundle of rank $m \leq n$. We say that E' is *co-orientable* if E/E' is orientable.

A hyperplane field $\xi \subset TM$ is therefore co-orientable if the line bundle TM/ξ is orientable, equivalently, if TM/ξ is trivial.

Proposition 3.1.4. *A hyperplane field ξ over a manifold M is co-orientable if and only if it can be described globally as the kernel of some 1-form α on M .*

Proof. If ξ is co-orientable, then TM/ξ is a trivial line bundle, so that the dual bundle $(TM/\xi)^*$ is trivial, and hence admits a global nonzero section α , which is by definition a 1-form. We can pull this back to the tangent bundle TM via the projection $TM \rightarrow TM/\xi$ to obtain a global 1-form α such that $\xi = \ker \alpha$. Conversely, if a hyperplane field $\xi = \ker \alpha$ globally, for some 1-form α , then α defines a nonzero section of the line bundle $(TM/\xi)^*$, so that $(TM/\xi)^*$, and hence TM/ξ , are trivial, so ξ is co-orientable. \square

We are now in a position to define contact manifolds.

Definition 3.1.5. Let M be a manifold of dimension $2n + 1$. A *contact structure* on M is a co-orientable hyperplane field $\xi = \ker \alpha$, such that α has the property that the $(2n + 1)$ -form $\alpha \wedge (d\alpha)^n$ is nonzero everywhere on M . Here $(d\alpha)^n$ is used to mean $\underbrace{d\alpha \wedge \dots \wedge d\alpha}_{n \text{ times}}$.

We need to check that this is well defined, since the defining 1-form α is not unique. Since the locally defined 1-forms α_p are only unique up to multiplication by a nonzero scalar constant, the smooth 1-form α on M is only unique up to multiplication by a smooth function $f : M \rightarrow \mathbb{R} \setminus \{0\}$.

Proposition 3.1.6. *Let α be a smooth 1-form on a manifold M of dimension $2n + 1$ with the property that $\alpha \wedge (d\alpha)^n$ is nonzero everywhere on M , and let $f : M \rightarrow \mathbb{R} \setminus \{0\}$ be a smooth function. Then the $(2n + 1)$ -form $f\alpha \wedge (d(f\alpha))^n$ is also nonzero everywhere on M .*

Proof. We know that, if ω is a n -form and η is an l -form, $d(\omega \wedge \eta) = d\omega \wedge \eta + (-1)^n \omega \wedge d\eta$.

Since f is a smooth function, it is a 0-form, and α is a 1-form, we have $d(f\alpha) = d(f \wedge \alpha) = df \wedge \alpha + f \wedge d\alpha = df \wedge \alpha + fd\alpha$. Hence $f\alpha \wedge (d(f\alpha))^n = f\alpha \wedge (df \wedge \alpha + fd\alpha)^n$. This is just $f\alpha \wedge (fd\alpha)^n$, since all other terms in the expansion will contain an $\alpha \wedge \alpha$ term, which is zero because α is a 1-form. This is equal to $f^{n+1}\alpha \wedge (d\alpha)^n$.

Since f and $\alpha \wedge (d\alpha)^n$ are nonzero everywhere on M , we have that $f\alpha \wedge (d(f\alpha))^n = f^{n+1}\alpha \wedge (d\alpha)^n$ nonzero everywhere on M . \square

Hence, if there exists a defining 1-form of the hyperplane field ξ that is nonzero on M , every defining 1-form of ξ is nonzero on M . In other words, the notion of a contact structure on a manifold M is well defined.

Definition 3.1.7. Let M be an odd-dimensional real manifold equipped with a contact structure ξ on M . We call the pair (M, ξ) a *manifold with contact structure*, or more concisely a *contact manifold*.

A form α such that $\xi = \ker \alpha$ is called a *contact form*. Let M be an odd-dimensional manifold equipped with a contact form α . We call the pair (M, α) a *strict contact manifold*.

Recall that contact forms on (M, ξ) are not unique; they are only unique up to multiplication by a smooth function $f : M \rightarrow \mathbb{R}/\{0\}$. A *strict contact manifold* is a contact manifold $(M, \xi = \ker \alpha)$ with a specific choice of contact form α . A contact form α induces a volume form $\alpha \wedge (d\alpha)^n$, and so an orientation of M . We can use the co-orientability of ξ to define the induced orientation of a contact structure.

Definition 3.1.8. Let (M, ξ) be a contact structure, with a contact form α such that $\alpha > 0$ on TM/ξ . The orientation induced on M by the volume form $\alpha \wedge (d\alpha)^n$ is called the *orientation induced by ξ* .

This is well defined, since the condition $\alpha > 0$ on TM/ξ means that α is only unique up to multiplication by a strictly positive smooth function, which will not alter the orientation induced by the volume form $\alpha \wedge (d\alpha)^n$.

We give some examples of contact manifolds.

Example 3.1.9. The simplest contact manifold is \mathbb{R}^{2n+1} , with co-ordinates $(x_1, \dots, x_n, y_1, \dots, y_n, z)$, equipped with the form

$$\alpha_0 = dz - \sum_{i=1}^n y_i dx_i.$$

We compute

$$\alpha_0 \wedge (d\alpha_0)^n = n! dz \wedge dx_1 \wedge dy_1 \wedge \dots \wedge dx_n \wedge dy_n,$$

which is a volume form on \mathbb{R}^{2n+1} , so that α is a contact form, and its kernel is a contact structure. We call this the *standard contact structure* on \mathbb{R}^{2n+1} .

Example 3.1.10. We can also define a contact structure on the sphere S^{2n+1} . Consider \mathbb{R}^{2n+2} with co-ordinates $(x_1, \dots, x_{n+1}, y_1, \dots, y_{n+1})$ and the form

$$\alpha_0 = \sum_{j=1}^{n+1} (x_j dy_j - y_j dx_j).$$

Let r be the radial co-ordinate of \mathbb{R}^{2n+2} . We compute

$$\begin{aligned} r dr \wedge \alpha_0 \wedge (d\alpha_0)^n &= dr \wedge \sum_{j=1}^{n+1} (x_j dy_j - y_j dx_j) \wedge \left(d \left(\sum_{j=1}^{n+1} (x_j dy_j - y_j dx_j) \right) \right)^n \\ &= r dr \wedge \sum_{j=1}^{n+1} (x_j dy_j - y_j dx_j) \wedge \left(\sum_{j=1}^{n+1} (dx_j dy_j - dy_j dx_j) \right)^n \\ &= r dr \wedge \sum_{j=1}^{n+1} (x_j dy_j - y_j dx_j) \wedge \left(\sum_{j=1}^{n+1} (dx_j \wedge dy_j) \right)^n \\ &= \sum_{j=1}^{n+1} (x_j dx_j + y_j dy_j) \wedge \sum_{j=1}^{n+1} (x_j dy_j - y_j dx_j) \wedge \\ &\quad n! \sum_{j=1}^{n+1} dx_1 \wedge dy_1 \wedge \dots \wedge \widehat{dx}_j \wedge \widehat{dy}_j \wedge \dots \wedge dx_{n+1} \wedge dy_{n+1} \\ &= n! \sum_{j=1}^{n+1} (x_j^2 + y_j^2) dx_1 \wedge dy_1 \wedge \dots \wedge dx_{n+1} \wedge dy_{n+1} \\ &= n! r^2 dx_1 \wedge dy_1 \wedge \dots \wedge dx_{n+1} \wedge dy_{n+1}, \end{aligned}$$

which is nonzero for $r \neq 0$. So α_0 is a contact form on the nonzero level sets of dr , and so on $S^{2n+1} \subset \mathbb{R}^{2n+2}$, so its kernel is a contact structure on S^{2n+1} . We call this the *standard contact structure* on S^{2n+1} .

We define a notion of equivalence for contact manifolds.

Definition 3.1.11. Let $(M_1, \xi_1), (M_2, \xi_2)$ be contact manifolds. A *contactomorphism* is a diffeomorphism $\phi : M_1 \rightarrow M_2$ such that the differential $\phi_* : TM_1 \rightarrow TM_2$ satisfies $\phi_*(\xi_1) = \xi_2$.

Let $(M_1, \alpha_1), (M_2, \alpha_2)$ be strict contact manifolds. A *strict contactomorphism* is a diffeomorphism $\phi : M_1 \rightarrow M_2$ such that the pullback $\phi^* : T^*M_2 \rightarrow T^*M_1$ satisfies $\phi^*\alpha_2 = \alpha_1$.

Note that a strict contactomorphism is a contactomorphism, but the converse is not true, due to the fact that contact forms defining a given contact structure are not unique.

Proposition 3.1.12. *Let $(M, \xi = \ker \alpha)$ be a contact manifold. The form $d\alpha$ is a symplectic form on the contact structure ξ , that is, a closed 2-form such that its restriction to the fibres of ξ defines symplectic forms on those fibres.*

Proof. By definition, $d\alpha$ is a differential 2-form; since it is exact, it is closed. Because ξ is a co-orientable hyperplane field, TM/ξ is trivial, so the tangent bundle TM splits into the Whitney sum $\xi \oplus \underline{\mathbb{R}}$. Since $\xi = \ker \alpha$, we must have $(d\alpha)^n \neq 0$ on ξ , since $\alpha \wedge (d\alpha)^n \neq 0$. Hence, by Proposition 2.2.9, $d\alpha$ is a symplectic form on the fibres of ξ , and so on ξ . \square

Lemma 3.1.13. *Let (M, ξ) be a $(2n+1)$ -dimensional contact manifold. Then M admits a reduction of the structure group of its tangent bundle TM to $U(n) \oplus 1$, where 1 is the trivial group.*

Proof. Since TM/ξ is co-orientable, the tangent bundle splits into $\xi \oplus \underline{\mathbb{R}}$, and, by Proposition 3.1.12, ξ is a symplectic bundle. The structure group can therefore be reduced to $Sp(2n, \mathbb{R}) \oplus 1$, where 1 is the trivial group, specifically, the identity subgroup of $GL(1, \mathbb{R})$. By Lemma 2.3.13, we know that $Sp(2n, \mathbb{R})$ retracts to $U(n)$, so that TM admits a reduction of its structure group to $U(n) \oplus 1$. \square

This motivates the following definition.

Definition 3.1.14. Let M be a $(2n + 1)$ -dimensional manifold. An *almost contact structure* on M is a reduction of the structure group of its tangent bundle TM to $U(n) \oplus 1$.

Lemma 3.1.13 tells us that every contact manifold admits an almost contact structure.

3.2 Submanifolds of contact manifolds

Definition 3.2.1. Let (M, ξ) be a contact manifold, $L \subset M$ a submanifold. We say that L is a *contact submanifold* if it admits a contact structure ξ' such that $TL \cap \xi|_L = \xi'$.

Suppose that $\xi = \ker \alpha$. This condition is equivalent to $\xi' = \ker(i^*\alpha)$, where $i : L \rightarrow M$ is inclusion. In particular, ξ' is a symplectic subbundle of $\xi|_L$, with symplectic structure given by $d\alpha$ on ξ .

Definition 3.2.2. Let (M, ξ) be a contact manifold, $L \subset M$ a submanifold. We say that L is an *isotropic submanifold* if $TL \subset \xi$.

We need to justify the term isotropic in the definition.

Proposition 3.2.3. *Let L be an isotropic submanifold of (M, ξ) . Then $T_p L$ is an isotropic subspace of $(\xi_p, d\alpha_p)$ for all $p \in L$.*

Proof. Since $TL \subset \xi$, $T_p L$ is a subspace of the symplectic vector space ξ_p for all $p \in L$. Let α be a contact form defining ξ . Then $TL \subset \xi$ is equivalent to $i^*\alpha = 0$, where $i : L \rightarrow M$ is inclusion. We then have $i^*d\alpha = d(i^*\alpha) = 0$. This means that for all $x, y \in T_p L$, we have $d\alpha(x, y) = 0$. By fixing x , we have, by definition, $y \in (T_p L)^{d\alpha}$, using the notation of Section 2.2. Hence $T_p L \subset (T_p L)^{d\alpha}$, so that $T_p L$ is an isotropic subspace of $(\xi_p, d\alpha_p)$ for all $p \in L$. \square

Recall that for a subspace U of a symplectic vector space (V, ω) , that $\dim U + \dim U^\omega = \dim V$; in particular, this means that if $U \subset U^\omega$, then $\dim U \leq \frac{1}{2} \dim V$. Hence if L is an isotropic submanifold of a $(2n + 1)$ -dimensional contact manifold (M, ξ) , the rank of TL must be at most half the rank of ξ , which is n , so we have $\dim L \leq n$.

Definition 3.2.4. Let L be an isotropic submanifold of a contact manifold (M, ξ) . If M has dimension $2n + 1$, and L has dimension n , we say that L is a *Legendrian submanifold*.

Proposition 3.2.5. *Let L be a Legendrian submanifold of a contact manifold (M, ξ) . Then $T_p L$ is a Legendrian subspace of $(\xi_p, d\alpha_p)$ for all $p \in L$.*

Proof. Let $\dim M = 2n + 1$. Since L is an isotropic submanifold, we have $T_p L$ is an isotropic subspace of (ξ_p, α_p) for all $p \in L$. We therefore have $T_p L \subset (T_p L)^{d\alpha}$. We also know that $\dim T_p L + \dim (T_p L)^{d\alpha} = \dim \xi_p = 2n$, so that $\dim (T_p L)^{d\alpha} = 2n - \dim T_p L = n$, since L is a Legendrian submanifold. Hence we actually have $T_p L = (T_p L)^{d\alpha}$, so that $T_p L$ is a Legendrian subspace of (ξ_p, α_p) for all $p \in L$. \square

We will be using isotropic submanifolds later on, when we introduce contact surgery in Chapter 7.

3.3 Complex, almost complex, and stably complex manifolds

Definition 3.3.1. A *complex structure* on a manifold M is an atlas of charts $\mathcal{A} = \{(U_\alpha, \phi_\alpha)\}$ for M into open subsets of \mathbb{C}^n whose transition maps are holomorphic. We call the pair (M, \mathcal{A}) a *complex manifold*.

This definition is equivalent to saying that M is a manifold over \mathbb{C} as well as \mathbb{R} . Since \mathbb{C} is a 2-dimensional real manifold, this implies that a complex manifold must have even real dimension. We can define a less restrictive structure on a manifold via its tangent bundle.

Definition 3.3.2. An *almost complex structure* on a manifold M is a collection J of linear maps $J_p : T_p M \rightarrow T_p M$ that vary smoothly with p , with the property that for all $p \in M$, $J_p : T_p M \rightarrow T_p M$ satisfies $J_p^2 = -I$, in other words, a collection of linear complex structures J_p on $T_p M$ that vary smoothly with p . We call the pair (M, J) a *manifold with almost complex structure*, or, more concisely, an *almost complex manifold*.

An almost complex manifold must be of even dimension, since the tangent spaces must be of even dimension. We can make the definition more concise by using tensor fields, so an almost complex structure on a manifold is a smooth tensor field J of type $(1, 1)$ such that $J^2 = -I$.

As in the case with symplectic vector spaces, we can say that a such a complex structure on a symplectic vector bundle is *compatible* with the symplectic structure if the complex structure is compatible with the symplectic form on the fibres of the bundle. In particular, if M is a symplectic manifold, that is, a manifold equipped with a global symplectic form, we can refer to complex structures that are compatible with the symplectic structure of the manifold.

Proposition 3.3.3. *Every complex manifold is also an almost complex manifold. Moreover, for a complex manifold (M, \mathcal{A}) of dimension $2n$, given local complex co-ordinates (z_1, \dots, z_n) , where $z_j = x_j + iy_j$, an explicit almost complex structure J is given by $J\left(\frac{\partial}{\partial x_j}\right) = \frac{\partial}{\partial y_j}$, $J\left(\frac{\partial}{\partial y_j}\right) = -\frac{\partial}{\partial x_j}$.*

Proof. Let M be a complex manifold of dimension $2n$. Since M has a complex structure, it is a manifold over \mathbb{C} , so its tangent bundle TM must be a

complex vector bundle. Hence TM admits a reduction of the structure group from $GL(2n, \mathbb{R})$ to $GL(n, \mathbb{C})$, so that M admits an almost complex structure.

Let (z_1, \dots, z_n) be local complex co-ordinates at $p \in M$, where $z_j = x_j + iy_j$. We have a basis for the tangent space T_pM , namely

$$\left\{ \frac{\partial}{\partial x_1}, \frac{\partial}{\partial y_1}, \dots, \frac{\partial}{\partial x_n}, \frac{\partial}{\partial y_n} \right\}.$$

We define the tensor field J on M by the equations

$$J\left(\frac{\partial}{\partial x_j}\right) = \frac{\partial}{\partial y_j}, \quad J\left(\frac{\partial}{\partial y_j}\right) = -\frac{\partial}{\partial x_j}.$$

Since the vector fields $\frac{\partial}{\partial x_j}$ vary smoothly over M , J is a smooth tensor field; clearly, $J^2 = -I$.

We need to verify that J is well defined, so J must be compatible with transition maps of the complex structure \mathcal{A} . Let f be a transition map at p , so that f is a diffeomorphism, and holomorphic with a holomorphic inverse, from an open neighbourhood of (z_1, \dots, z_n) to another open set of \mathbb{C}^n . Since f is continuous, by Osgood's lemma, this is equivalent to being holomorphic in each variable, so the f_k satisfy the Cauchy-Riemann equations in each variable. We have, for $j = 1, \dots, n$,

$$J\left(\frac{\partial}{\partial x_j}\right) = J\left(\sum_{k=1}^n \frac{\partial u_k}{\partial x_j} \cdot \frac{\partial}{\partial u_k}\right),$$

by the chain rule. In the same way,

$$J\left(\frac{\partial}{\partial y_j}\right) = J\left(\sum_{k=1}^n \frac{\partial v_k}{\partial y_j} \cdot \frac{\partial}{\partial v_k}\right).$$

By applying the definition J , the linearity of J , and the Cauchy-Riemann

equations, this gives

$$\begin{aligned}
& J \left(\sum_{k=1}^n \frac{\partial u_k}{\partial x_j} \cdot \frac{\partial}{\partial u_k} \right) = J \left(\sum_{k=1}^n \frac{\partial v_k}{\partial y_j} \cdot \frac{\partial}{\partial v_k} \right) \\
& \Rightarrow \sum_{k=1}^n \frac{\partial u_k}{\partial x_j} J \left(\frac{\partial}{\partial u_k} \right) = \sum_{k=1}^n \frac{\partial v_k}{\partial y_j} J \left(\frac{\partial}{\partial v_k} \right) \\
& \Rightarrow \sum_{k=1}^n \frac{\partial u_k}{\partial x_j} J \left(\frac{\partial}{\partial u_k} \right) = \sum_{k=1}^n \frac{\partial u_k}{\partial x_j} J \left(\frac{\partial}{\partial v_k} \right) \\
& \Rightarrow \sum_{k=1}^n \frac{\partial u_k}{\partial x_j} \left(J \left(\frac{\partial}{\partial u_k} \right) - J \left(\frac{\partial}{\partial v_k} \right) \right) = 0 \quad \text{for } j = 1, \dots, n.
\end{aligned}$$

We can rewrite this as a matrix equation,

$$\left(J \left(\frac{\partial}{\partial u_1} \right) - J \left(\frac{\partial}{\partial v_1} \right) \quad \dots \quad J \left(\frac{\partial}{\partial u_n} \right) - J \left(\frac{\partial}{\partial v_n} \right) \right) \begin{pmatrix} \frac{\partial u_1}{\partial x_1} & \dots & \frac{\partial u_1}{\partial x_n} \\ \vdots & & \vdots \\ \frac{\partial u_n}{\partial x_1} & \dots & \frac{\partial u_n}{\partial x_n} \end{pmatrix} = 0.$$

Since f is holomorphic with a holomorphic inverse, the function $\text{Re } f = (u_1, \dots, u_n)$ must be (real) differentiable with a differentiable inverse. This means the second matrix is invertible, so the first matrix must be zero. Hence we have

$$J \left(\frac{\partial}{\partial u_k} \right) = \frac{\partial}{\partial v_k}.$$

In the same way, applying the other Cauchy-Riemann equation gives

$$J \left(\frac{\partial}{\partial v_k} \right) = -\frac{\partial}{\partial u_k}.$$

Hence J is compatible with transition maps and so is well defined, and $J^2 = -I$. So J is an almost complex structure on M . We call J the almost complex structure *induced by the complex structure* \mathcal{A} . \square

Every complex manifold is almost complex. However, the converse is not true; see [13].

Proposition 3.3.4. *A manifold M of dimension $2n$ admits an almost complex structure if and only if its tangent bundle TM admits a reduction of the structure group from $GL(2n, \mathbb{R})$ to $U(n)$.*

Proof. By definition, an almost complex structure gives the tangent bundle TM the structure of a complex vector bundle. Hence an almost complex structure is equivalent to a reduction of the structure group of the tangent bundle from $GL(2n, \mathbb{R})$ to $GL(n, \mathbb{C})$. By Lemma 2.3.13, $U(n)$ is a deformation retract of $GL(n, \mathbb{C})$, so this is equivalent to a reduction of the structure group from $GL(2n, \mathbb{R})$ to $U(n)$. \square

We can generalise almost complex structures further.

Definition 3.3.5. A *stable complex structure* on a real vector bundle E with base B is a complex structure c on the Whitney sum $E \oplus \underline{\mathbb{R}}^k$ of E with some trivial bundle over B . A *stable complex structure* on a manifold M is a stable complex structure c on its tangent bundle TM .

We call the pair (M, c) a *stably complex manifold*.

Note that a stable complex manifold can be of any dimension; we only require $n + k$ even, since a complex vector bundle must have even real rank. An almost complex manifold is a stably complex manifold where k can be chosen to be 0.

Proposition 3.3.6. A manifold M of dimension n admits a stable complex structure if and only if there exists a $k \in \mathbb{N}$ such that the vector bundle $TM \oplus \underline{\mathbb{R}}^k$ admits a reduction of its structure group from $GL(n + k, \mathbb{R})$ to $U(\frac{1}{2}(n + k))$.

Proof. By definition, a stable complex structure is a complex vector bundle structure on $TM \oplus \underline{\mathbb{R}}^k$, which is equivalent to a reduction of the structure group from $GL(n + k, \mathbb{R})$ to $GL(\frac{1}{2}(n + k), \mathbb{C})$. Since $U(\frac{1}{2}(n + k))$ is a deformation retract of $GL(\frac{1}{2}(n + k), \mathbb{C})$, this is equivalent to a reduction of the structure group to $U(\frac{1}{2}(n + k))$. \square

We can now deduce the result that will allow us to use contact manifolds in complex cobordism.

Lemma 3.3.7. Let M be a manifold of dimension $2n + 1$ that admits a contact structure. Then M admits a stable complex structure.

Proof. We know, from Lemma 3.1.13, that if M is a contact manifold of dimension $2n + 1$, its tangent bundle TM admits a reduction of its structure group from $GL(2n + 1, \mathbb{R})$ to $U(n) \oplus 1$. This means that the bundle $TM \oplus \underline{\mathbb{R}}$ admits a reduction of the structure group $U(n) \oplus 1 \oplus 1$, since $\underline{\mathbb{R}}$ is a trivial

line bundle over M . Now we can view $U(n) \oplus 1 \oplus 1$ which we can view as a subset of $U(n+1)$ via the obvious inclusion over \mathbb{R} :

$$U(n) \oplus 1 \oplus 1 \hookrightarrow U(n+1)$$
$$(I_2, A) \mapsto \begin{pmatrix} A & 0 \\ 0 & I_2 \end{pmatrix}.$$

Hence $TM \oplus \underline{\mathbb{R}}$ admits a reduction of the structure group to $U(n+1)$, so, by Proposition 3.3.4, M admits a stable complex structure. \square

Chapter 4

Universal bundles and classifying spaces

For the results of the next few chapters, we need to understand classifying spaces of topological groups.

4.1 Universal bundles

Definition 4.1.1. Let G be a topological group, $EG \rightarrow BG$ a principal G -bundle. Let X be a CW-complex, with $[X, BG]$ the set of homotopy classes of maps $X \rightarrow BG$ and $\mathcal{P}_G X$ the set of equivalence classes of principal G -bundles over X .

We say that $EG \rightarrow BG$ is a *universal bundle* for CW-complexes, if, for every CW-complex X , the map

$$\begin{aligned} [X, BG] &\rightarrow \mathcal{P}_G X \\ [f] &\mapsto f^* EG, \end{aligned}$$

where $f^* EG$ is the pullback bundle of EG by f (for any f representing the homotopy class $[f]$), is bijective.

We call BG a *classifying space* of G , and the map $X \rightarrow BG$ a *classifying map*.

The bijective correspondence between G -bundles with a particular base space and fibre and their associated principal G -bundles, allows us to classify other G -bundles as well. We need one more definition before we can state an important theorem.

Definition 4.1.2. A topological space X is called *contractible* if it is homotopy equivalent to a point, and *weakly contractible* if all of its homotopy groups vanish.

Clearly a contractible space is weakly contractible. Moreover, a weakly contractible CW-complex is contractible, by Whitehead's Theorem.

Theorem 4.1.3. *A principal G -bundle is universal if and only if its total space is weakly contractible.*

Proof. This was proven by Steenrod in [11], although he used a slightly different characterisation of universality. \square

Theorem 4.1.4. *Every topological group G has a universal bundle. Moreover, the classifying space BG is unique up to homotopy type.*

Proof. This theorem was proven by Milnor in [8]. We prove the uniqueness statement here.

Suppose that $E_1G \rightarrow B_1G$, $E_2G \rightarrow B_2G$ are universal bundles for G . Using the definitions, and the fact that universal bundles are principal bundles, we have a classifying map $f : B_1G \rightarrow B_2G$ that induces an isomorphism $E_1G \rightarrow f^*E_2G$. Similarly, we have a classifying map $g : B_2G \rightarrow B_1G$ that induces an isomorphism $E_2G \rightarrow g^*E_1G$.

Consider the map $g \circ f : B_1G \rightarrow B_1G$. We compute the pullback:

$$\begin{aligned} (g \circ f)^*E_1 &= f^*(g^*E_1G) \\ &\cong f^*(E_2) \\ &\cong E_1G, \end{aligned}$$

using the isomorphisms that result from the definition of f, g as classifying maps. Hence $(g \circ f)^*E_1G \cong \text{id}^*E_1G$, so that the maps $(f \circ g)$ and id induce the same pullback bundles. Using the bijection in the definition of the universal bundle, this means that $g \circ f \simeq \text{id}_{B_1G}$. In the same way, $f \circ g \simeq \text{id}_{B_2G}$. Hence B_1G is homotopy equivalent to B_2G . \square

In this way, the associated principal $O(n)$ -bundle of the tangent bundle of a manifold M can be classified by a map $M \rightarrow BO(n)$. In a similar way, the associated principal $U(n)$ -bundle of the tangent bundle of an almost complex manifold M of dimension $2n$ can be classified by a map $M \rightarrow BU(n)$. We can use the above theorems to define fibrations of classifying spaces, which will relate the two.

Theorem 4.1.5. *If H is a closed subgroup of G , there exist classifying spaces BG, BH for G and H respectively, and a fibration*

$$G/H \rightarrow BH \rightarrow BG.$$

Proof. By Theorem 4.1.4, we have a universal bundle $EG \rightarrow BG = EG/G$ for G , with EG contractible. Since $EG \rightarrow BG$ is a principal G -bundle, G acts freely on EG . Since H is a closed subgroup of G , H also acts freely on EG , so we have a principal H -bundle $EG \rightarrow EG/H$; since EG is contractible, this is a universal bundle for H , by Theorem 4.1.3, so we let $BH = EG/H$.

We define the map $p : BH \rightarrow BG, p([x]_H) = [x]_G$, where $x \in EG$, and $[x]_G, [x]_H$ are the equivalence classes represented by x , under G - and H -action respectively. The fibre is the set of equivalence classes $[\tilde{x}]_H \bmod H$, such that $g(\tilde{x}) = x$ for some $g \in G$. Clearly $g(\tilde{x}) = g'(\tilde{x})$ if and only if $gH = g'H$, so that the fibre is just the coset space G/H . \square

This gives us another way to describe the reduction of the structure group G of a principal G -bundle over X to a closed subgroup H of G . It is a lift of the classifying map $X \rightarrow BG$ to a map $X \rightarrow BH$. We can define the homotopy class of a reduction, namely, the homotopy class of the map into G/H that gives the lift from BG to BH .

We can now prove Lemma 2.3.14.

Lemma 4.1.6. *Suppose G is a topological group, $H \subset G$ a subgroup, and G deformation retracts onto H . Then any G -bundle admits a reduction of its structure group from G to H .*

Proof. Suppose a principal bundle is classified by a map $f : X \rightarrow BG$. We need to find a lift of a map $f : X \rightarrow BH$, but since the fibre of the projection is contractible, the projection is a homotopy equivalence. We know that homotopy equivalence is a bijective correspondence between homotopy classes of maps into BG and BH , so the lift exists.

Applying the bijective correspondence between G -bundles with particular fibre and their associated principal G -bundles gives the result. \square

Lemma 2.3.14 follows immediately, so, as already noted, real vector bundles have structure group $O(n)$, and complex vector bundles have structure group $U(n)$. A real vector bundle admits a complex structure if and only if its classifying map into $BO(2n)$ admits a lift to $BU(n)$. In particular, a $(2n)$ -dimensional manifold admits an almost complex structure if and only

if the classifying map of its tangent bundle admits a lift from $BO(2n)$ to $BU(n)$, and a $(2n - 1)$ -dimensional manifold admits an almost contact structure if and only if the classifying map of its tangent bundle admits a lift from $BO(2n + 1)$ to $BU(n)$.

4.2 Universal bundles for $O(n)$ and $U(n)$

We can explicitly construct universal bundles for $O(n)$ and $U(n)$. We will focus on constructing a universal bundle for $O(n)$, as the construction for $U(n)$ follows immediately by replacing the real numbers with the complex numbers. Note that the classifying spaces from this construction will only be unique up to homotopy type.

Definition 4.2.1. Let $k \geq n$. Define the *Stiefel manifold*, $V_n(\mathbb{R}^k)$, as the set of all n -frames in \mathbb{R}^k , where an n -frame is an n -tuple of orthonormal vectors.

Analogously, we define complex and quaternionic Stiefel manifolds by replacing \mathbb{R} by \mathbb{C} or \mathbb{H} respectively.

Definition 4.2.2. Let $k \geq n$. Define the *Grassmann manifold* or *Grassmannian*, $G_n(\mathbb{R}^k)$, as the set of all n -dimensional subspaces of \mathbb{R}^k .

As for the Stiefel manifolds, we define complex and quaternionic Grassmann manifolds by replacing \mathbb{R} by \mathbb{C} or \mathbb{H} respectively.

We need to justify the use of the term *manifold* in the above definitions.

Proposition 4.2.3. *Let $k \geq n$. The Stiefel manifold $V_n(\mathbb{R}^k)$ is a smooth manifold of dimension $nk - \frac{1}{2}n(n + 1)$.*

Proof. We can view the Stiefel manifold as a subset of $M_{k \times n}(\mathbb{R}) \cong \mathbb{R}^{nk}$, by letting the elements of an n -frame be the columns of a $k \times n$ matrix. The orthogonality condition on the n -frames is equivalent to the condition that for $A \in V_n(\mathbb{R}^k) \subset M_{k \times n}(\mathbb{R})$, we require $A^T A = 1$, so that we can view $V_n(\mathbb{R}^k)$ as the preimage of a smooth function in the entries of A . To compute its dimension, we add the vectors in the n -frame one by one: the i^{th} vector must have norm 1, which is one equation that is smooth in the entries of the vector, and must be orthogonal to the first $i - 1$ equations, giving i smooth equations, in total, independent from all the previous ones, for the i^{th} vector in the frame. Hence the orthogonality condition on the frame is equivalent to satisfying an irreducible system of $1 + 2 + 3 + \dots + n =$

$\frac{1}{2}n(n+1)$ smooth equations, so that $V_n(\mathbb{R}^k)$ is a smooth manifold of dimension $nk - \frac{1}{2}n(n+1)$. \square

Proposition 4.2.4. *There is a principal $O(n)$ -bundle*

$$O(n) \rightarrow V_n(\mathbb{R}^k) \rightarrow G_n(\mathbb{R}^k).$$

Proof. There is a natural projection $p : V_n(\mathbb{R}^k) \rightarrow G_n(\mathbb{R}^k)$, which sends an n -frame in \mathbb{R}^k to the n -dimensional subspace of \mathbb{R}^k it spans. By definition, the fibre of this projection is the set of all orthonormal n -frames contained in that n -dimensional subspace, which is isomorphic to \mathbb{R}^n . We can view an orthonormal n -frame in \mathbb{R}^n as a matrix in $O(n)$ by identifying the vectors in the n -frames with columns of the matrix, so the fibre is $O(n)$.

This is a principal $O(n)$ -bundle as follows. There is a natural action of $O(n)$ on $V_n(\mathbb{R}^k)$ by applying a transformation in $O(n)$ to an n -frame in $V_n(\mathbb{R}^k)$. The orbits of this action are the set of n -frames in a particular n -dimensional subspace of \mathbb{R}^k , which is $O(n)$, the fibre of the bundle. \square

Proposition 4.2.5. *The Grassmann manifold $G_n(\mathbb{R}^k)$ is a smooth manifold of dimension $n(k-n)$.*

Proof. We can view the principal $O(n)$ -bundle in Proposition 4.2.4 as the action of $O(n)$ on $V_n(\mathbb{R}^k)$, with quotient $G_n(\mathbb{R}^k)$. The action of $O(n)$ is free, since only the identity in $O(n)$ preserves any n -frame in $V_n(\mathbb{R}^k)$. The action is also proper, since $O(n)$ is compact. The dimension of $O(n)$ is $\frac{1}{2}n(n-1)$. We can now apply the quotient manifold theorem to deduce that $G_n(\mathbb{R}^k)$ is a smooth manifold of dimension $[nk - \frac{1}{2}n(n+1)] - [\frac{1}{2}n(n-1)] = n(k-n)$. \square

Note that by replacing \mathbb{R} by \mathbb{C} , we obtain a principal $U(n)$ -bundle

$$U(n) \rightarrow V_n(\mathbb{C}^k) \rightarrow G_n(\mathbb{C}^k).$$

We can view \mathbb{R}^k as a subspace of \mathbb{R}^{k+1} . By applying this repeatedly, we obtain sequences of inclusions

$$\begin{aligned} V_n(\mathbb{R}^k) &\hookrightarrow V_n(\mathbb{R}^{k+1}) \hookrightarrow \dots \\ G_n(\mathbb{R}^k) &\hookrightarrow G_n(\mathbb{R}^{k+1}) \hookrightarrow \dots \end{aligned}$$

Taking the direct limit as $k \rightarrow \infty$ gives the spaces $V_n(\mathbb{R}^\infty)$, $G_n(\mathbb{R}^\infty)$, and similarly for \mathbb{C}, \mathbb{H} . Since the finite-dimensional Stiefel and Grassmann manifolds

are smooth manifolds, they are CW-complexes. Taking the direct limit in the sequences of inclusions as above gives an infinite CW-complex structure on $V_n(\mathbb{R}^\infty), G_n(\mathbb{R}^\infty)$.

We now obtain bundles

$$\begin{aligned} O(n) &\rightarrow V_n(\mathbb{R}^\infty) \rightarrow G_n(\mathbb{R}^\infty) \\ U(n) &\rightarrow V_n(\mathbb{C}^\infty) \rightarrow G_n(\mathbb{R}^\infty). \end{aligned}$$

We want to prove that these are universal bundles, but first we need to prove a lemma.

Definition 4.2.6. Let X be a topological space, A a subspace. A *weak deformation retraction* of X to A is a homotopy $f_t : X \rightarrow X$ such that $f_0 = \text{id}_X$, $f_1(X) \subset A$, and $f_t(A) \subset A$ for all $t \in [0, 1]$.

Lemma 4.2.7. *If there exists a weak deformation retraction f_t from X to $A \subset X$, then the inclusion $i : A \hookrightarrow X$ is a homotopy equivalence.*

Proof. We have $f_1(x) \subset A$. We claim that the map $f_1 : X \rightarrow A$ is a homotopy inverse of the inclusion i . By definition, $i \circ f_1 = f_1$ is homotopic in X to id_X . $f_1 \circ i = f_1 : A \rightarrow A$ is homotopic to id_A , since the homotopy $f_t : X \rightarrow X$ satisfies $f_t(A) \subset A$, so we can view it as a homotopy in A . \square

Theorem 4.2.8. *The space $V_n(\mathbb{R}^\infty)$ is contractible.*

Proof. Define a linear map

$$h_t : \mathbb{R}^\infty \rightarrow \mathbb{R}^\infty, h_t(x_1, x_2, \dots) = (1 - t)(x_1, x_2, \dots) + t(0, x_1, x_2, \dots).$$

The kernel of this map is obviously trivial, so when applied to each vector in an n -frame, it yields a n -tuple of linearly independent vectors. We can obtain another n -frame from this by the Gram-Schmidt process, so h_t , with the Gram-Schmidt process for each t , defines a weak deformation retraction on $V_n(\mathbb{R}^\infty)$ to the subspace of n -frames where the first co-ordinate in each vector in the n -frame is 0. By applying this repeatedly, we have a weak deformation retract to the subspace of n -frames with first n co-ordinates 0.

We can now define a homotopy on this subspace, $(v_1, \dots, v_n) \mapsto (1 - t)(v_1, \dots, v_n) + t(e_1, \dots, e_n)$, where e_i is the standard basis vector with i th co-ordinate 1 and all other co-ordinates 0. Since the first n co-ordinates of the v_i are 0, while all but the first n co-ordinates of the e_i are zero,

this homotopy preserves the linear independence, so we can again apply the Gram-Schmidt process to obtain a weak deformation through n -frames to the single point (e_1, \dots, e_n) . Hence $V_n(\mathbb{R}^\infty)$ admits a weak deformation retraction to a point, and so, by Lemma 4.2.7, the inclusion of that point into $V_n(\mathbb{R}^\infty)$ is a homotopy equivalence, so that $V_n(\mathbb{R}^\infty)$ is contractible. \square

Corollary 4.2.8.1. *The bundle*

$$O(n) \rightarrow V_n(\mathbb{R}^\infty) \rightarrow G_n(\mathbb{R}^\infty)$$

is a universal bundle for $O(n)$.

Proof. Because $V_n(\mathbb{R}^\infty)$ is contractible, it is weakly contractible and we can apply Theorem 4.1.3. \square

In the same way, we have the universal bundle for $U(n)$, namely

$$U(n) \rightarrow V_n(\mathbb{C}^\infty) \rightarrow G_n(\mathbb{C}^\infty).$$

There is one final construction we make for these classifying spaces, which is the associated vector bundle of the universal $O(n)$ -bundle.

Definition 4.2.9. Let $G_n(\mathbb{R}^k)$ be the Grassmannian of n -planes in \mathbb{R}^k . Define $\gamma_n^k = \{(V, v) : V \in G_n(\mathbb{R}^k), v \in V\}$, that is, the set of pairs consisting of an n -plane in \mathbb{R}^k with a point in that space. Define the *tautological bundle* as $p : \gamma_n^k \rightarrow G_n(\mathbb{R}^k), p(V, v) = V$.

Proposition 4.2.10. *The tautological bundle $p : \gamma_n^k \rightarrow G_n(\mathbb{R}^k)$ is a vector bundle, and its associated $O(n)$ -bundle is $V_n(\mathbb{R}^k) \rightarrow G_n(\mathbb{R}^k)$.*

Proof. Let $V \in G_n(\mathbb{R}^k)$. The fibre of p is $\{(V, v) : v \in V\}$, and we can give this the structure of a vector space isomorphic to V via the operations $a(V, v) + b(V, w) = (V, av + bw)$. Hence $p : \gamma_n^k \rightarrow G_n(\mathbb{R}^k)$ is a vector bundle of rank n .

Its associated G bundle is formed from the set of n -frames in each fibre with the action of $O(n)$, which, by definition, is the bundle $V_n(\mathbb{R}^k) \rightarrow G_n(\mathbb{R}^k)$. \square

Using the inclusion of \mathbb{R}^k in \mathbb{R}^{k+1} , we have a sequence of inclusions

$$\gamma_n^k \hookrightarrow \gamma_n^{k+1} \hookrightarrow \dots,$$

so we can take the direct limit and define $\gamma_n = \lim_{k \rightarrow \infty} \gamma_n^k$, the *universal tautological bundle* of rank n .

Since we used the same construction to define $EO(n) \rightarrow BO(n)$, this is the vector bundle whose associated principal $O(n)$ -bundle is $EO(n) \rightarrow BO(n)$, so that every vector bundle over X is a pullback $f^*\gamma_n$ of a map $f : X \rightarrow BO(n)$. In this way, we can classify vector bundles directly and avoid using their associated principal bundles.

4.3 Stable vector bundles

In this section we discuss the notion of stable vector bundles and their relation to classifying spaces.

Definition 4.3.1. We say that two vector bundles are *stably equivalent* if summing each vector bundle with a trivial vector bundle produces isomorphic vector bundles.

This is an equivalence relation as follows. Reflexivity and symmetry follow from the properties of bundle isomorphisms, and if $E_1 \oplus \underline{\mathbb{R}}^i \cong E_2 \oplus \underline{\mathbb{R}}^j$ and $E_2 \oplus \underline{\mathbb{R}}^k \cong E_3 \oplus \underline{\mathbb{R}}^l$, where $j \leq k$ without loss of generality, we simply add $k - j$ trivial line bundles to $E_1 \oplus \underline{\mathbb{R}}^i \cong E_2 \oplus \underline{\mathbb{R}}^j$, then transitivity follows. Hence we can define equivalence classes.

Definition 4.3.2. The equivalence classes of vector bundles with respect to stable equivalence are called *stable vector bundles*.

Definition 4.3.3. The equivalence class of the tangent bundle of a manifold with respect to stable equivalence is called the *stable tangent bundle*.

We want to classify these objects in the same way we classify vector bundles. We will focus on the orthogonal groups and real vector bundles, but the case for complex vector bundles and the unitary groups is analogous.

We can define an inclusion of orthogonal groups as follows:

$$\begin{aligned} O(n) &\hookrightarrow O(n+1) \\ A &\mapsto \begin{pmatrix} A & 0 \\ 0 & 1 \end{pmatrix} \end{aligned} \tag{4.1}$$

This induces a corresponding inclusion of classifying spaces:

$$\begin{aligned} BO(n) = G_n(\mathbb{R}^\infty) &\hookrightarrow G_{n+1}(\mathbb{R}^\infty) = BO(n+1) \\ V &\mapsto V \oplus \mathbb{C}. \end{aligned}$$

By applying this inclusion repeatedly, we obtain a sequence of inclusions of orthogonal groups

$$O(n) \hookrightarrow O(n+1) \hookrightarrow O(n+2) \hookrightarrow \dots,$$

and a corresponding sequence of inclusions of classifying spaces

$$BO(n) \hookrightarrow BO(n+1) \hookrightarrow BO(n+2) \hookrightarrow \dots$$

By applying the direct limit, we arrive at the following definition.

Definition 4.3.4. The *stable orthogonal group*, denoted O , is the direct limit, as $n \rightarrow \infty$, of the orthogonal group $O(n)$.

So we have

$$O(0) \hookrightarrow O(1) \hookrightarrow O(2) \hookrightarrow \dots \hookrightarrow O = \bigcup_{n=0}^{\infty} O(n)$$

Applying this direct limit to the inclusions of classifying spaces corresponding to these inclusions, we arrive at the classifying space BO for the stable orthogonal group.

Suppose a vector bundle E over a complex X is classified by a map $f_0 : X \rightarrow BO(n)$. We can then classify $E \oplus \underline{\mathbb{R}}$ by composing f with the inclusion in 4.1, since the added bundle is trivial. In this way, we have a series of maps $f_i : X \rightarrow BO(n+i)$ classifying the bundles $E \oplus \underline{\mathbb{R}}^i$. In particular, we can compose the classifying map with the inclusion $BO(n) \hookrightarrow BO$. We want to show that stable vector bundles are classified by this map. First we need a fact about CW-complexes.

Lemma 4.3.5. *Let X be a compact space, Y a CW-complex, $f : X \rightarrow Y$ a continuous map. Then the image $f(X)$ is in a finite subcomplex of Y .*

Proof. We know that every compact set in a CW-complex is contained within a finite subcomplex, and we know that continuous maps preserve compactness. Hence $f(X) \subset Y$ is compact, and so is contained in a finite subcomplex of Y . \square

Theorem 4.3.6. *Let X be a finite CW-complex. Let $E_0, E_1 \rightarrow X$ be vector bundles over X . Then E_0, E_1 are stably equivalent if and only if the composition of their classifying maps with the inclusion $BO(n) \hookrightarrow BO$ are homotopic.*

Proof. Suppose the vector bundles $E_0, E_1 \rightarrow X$ of rank r_0, r_1 are stably equivalent. Then $E_0 \oplus \underline{\mathbb{R}}^{i_0} \cong E_1 \oplus \underline{\mathbb{R}}^{i_1}$ for some $i_0, i_1 \in \mathbb{N}$. Suppose this bundle has rank $r = r_0 + i_0 = r_1 + i_1$. Composing the classifying maps of E_0, E_1 with the inclusions $O(i_0) \hookrightarrow O(r), O(i_1) \hookrightarrow O(r)$ gives us classifying maps $X \rightarrow BO(r)$ for the vector bundles $E_0 \oplus \underline{\mathbb{R}}^{i_0}, E_1 \oplus \underline{\mathbb{R}}^{i_1}$. Since these two bundles are isomorphic, by definition of classifying spaces, their classifying maps are homotopic. Composing with the natural inclusion into BO completes one direction of implication.

Suppose the vector bundles $E_0, E_1 \rightarrow X$ have classifying maps $f_0 : X \rightarrow BO(r_0), f_1 : X \rightarrow BO(r_1)$. Let the composition of these maps with the inclusion into BO be \tilde{f}_0, \tilde{f}_1 and suppose these maps are homotopic. Since X is finite, it is compact. From the results of Section 4.2, we know that $BO(n)$ is a CW-complex, so $BO = \bigcup_{n=0}^{\infty} BO(n)$ is also a CW-complex. Hence the homotopy \tilde{f}_t between \tilde{f}_0 and \tilde{f}_1 is a map from a compact space $X \times [0, 1]$ into an infinite CW-complex BO and so, by Lemma 4.3.5, must have its image in a finite subcomplex of BO , and so in $BO(r)$ for some suitably large r . Hence \tilde{f}_0, \tilde{f}_1 are just the composition of the classifying maps f_0, f_1 with the inclusions into $BO(r)$ for some $r \geq r_0, r_1$, which classify the bundles $E_0 \oplus \underline{\mathbb{R}}^{r-r_0}, E_1 \oplus \underline{\mathbb{R}}^{r-r_1}$, and are homotopic in $BO(r)$. By definition of classifying maps, this gives $E_0 \oplus \underline{\mathbb{R}}^{r-r_0} \cong E_1 \oplus \underline{\mathbb{R}}^{r-r_1}$, so that E_0, E_1 are stably equivalent. \square

We therefore have a bijection between homotopy classes of maps $X \rightarrow BO$ and stable vector bundles over X , so we can classify stable vector bundles as we classify vector bundles. In particular, the stable tangent bundle of a manifold M can be classified by a map $M \rightarrow BO$. We can define the stable unitary group U and its classifying space BU in an analogous fashion, and similar arguments allow us to classify vector bundles with stable complex structure by a map into BU , so a vector bundle over X admits a stable complex structure if and only if its stable classifying map $X \rightarrow BO$ admits a lift to BU .

Chapter 5

Cobordism and the Thom-Pontrjagin Theorem

This treatment broadly follows the treatment of Stong in [12]; however, we have avoided using category theory in developing cobordism theory.

5.1 Manifolds with (B, f) structure

We want to talk about manifolds with a specific structure on their stable normal bundles. We need to construct the tools to make this notion precise.

Definition 5.1.1. Let $f_n : B_n \rightarrow BO(n)$ be a fibration. Let ξ be a vector bundle over a space X classified by a map $\xi : X \rightarrow BO(n)$.

A (B_n, f_n) -structure on ξ is a homotopy class of lifts of the classifying map to B_n .

The bijective correspondence between homotopy classes of classifying maps and equivalence classes of pullback bundles means that classifying maps of a particular bundle are only unique up to homotopy, and, using the homotopy lifting property of fibrations, so are the lifts in the definition above. This is why the definition uses homotopy classes of maps.

Definition 5.1.2. Suppose $i : L \rightarrow M$ is an embedding of manifolds. We define the *normal bundle* of L in M , with respect to i , as i^*TM/TL , equivalently, as $TM|_L/TL$.

There are two examples of this that we will be using in this chapter. For a manifold M with boundary, we have the normal bundle of the boundary ∂M in M , which is a line bundle. For every manifold M , we have, by the Whitney embedding theorem, the existence of embeddings in Euclidean space, which we can use to define the normal bundle of a manifold.

Definition 5.1.3. Let M be a manifold of dimension n with tangent bundle TM . Let $i : M \rightarrow \mathbb{R}^{n+r}$ be an embedding, with by $i^*T\mathbb{R}^{n+r}$ the pullback of the tangent bundle of \mathbb{R}^{n+r} by i . The *normal bundle* NM of M with respect to i is the quotient $i^*T\mathbb{R}^{n+r}/TM$.

Note that if we give $T\mathbb{R}^{n+r}$ the Riemannian metric corresponding to the usual inner product on \mathbb{R}^{n+r} , the total space of the normal bundle NM is the orthogonal complement of TM in $i^*T\mathbb{R}^{n+r}$; equivalently, the fibre N_pM of NM at $p \in M$ is the orthogonal complement of i_*T_pM in \mathbb{R}^{n+r} . Note as well that the normal bundle is a vector bundle of rank r and so admits a classifying map $\nu(i) : M \rightarrow BO(r)$.

We now consider (B_r, f_r) -structures on the normal bundles of a manifold. We need to ensure that these structures do not depend on the choice of embedding for suitably large r .

Definition 5.1.4. Let $i_1, i_2 : M \rightarrow \mathbb{N}$ be two immersions. A *regular homotopy* between i_1, i_2 is a homotopy $i_t : M \times [0, 1] \rightarrow \mathbb{N}$ such that i_t is an immersion for all $t \in [0, 1]$, and the induced map $i_{t*} : TM \rightarrow TN$ is also a homotopy.

Theorem 5.1.5. *Let M be an n -dimensional manifold. Any two $i_1, i_2 : M \rightarrow \mathbb{R}^{n+r}$ are regularly homotopic, for r sufficiently large, depending only on n .*

Proof. This was proven by Hirsch in [6]. □

Theorem 5.1.6. *Let M be an n -dimensional manifold. For r sufficiently large, depending only on n , there is a bijective correspondence between B_r, f_r structures for the normal bundles corresponding to any two embeddings $i_1, i_2 : M \rightarrow \mathbb{R}^{n+r}$.*

Proof. By Theorem 5.1.5, i_1 and i_2 are regularly homotopic. Composing this regular homotopy with the classifying map $\mathbb{R}^{n+r} \rightarrow BO(n+r)$ for $T\mathbb{R}^{n+r}$ gives a homotopy between the classifying maps of $i_1^*T\mathbb{R}^{n+r}, i_2^*T\mathbb{R}^{n+r}$, so that these bundles, and hence the corresponding normal bundles, are isomorphic,

so their classifying maps $\nu_1, \nu_2 : M \rightarrow BO(r)$ are homotopic. Then the homotopy lifting property of the fibration $f_r : B_r \rightarrow BO(r)$ associates each (B_r, f_r) -structure on ν_1 to a unique (B_r, f_r) -structure on ν_2 , and vice versa. \square

Note that this also implies that normal bundles of embeddings $M \rightarrow \mathbb{R}^{n+r}$ are isomorphic for sufficiently large r , so that the normal bundle is unique, up to isomorphism, for sufficiently large r . Hence the notion of a stable normal bundle is well defined, and is, by definition, the stable inverse of the stable tangent bundle.

Let (B, f) be a sequence of fibrations $f_r : B_r \rightarrow BO(r)$ and maps $g_r : B_r \rightarrow B_{r+1}$ such that the diagram

$$\begin{array}{ccc} B_r & \xrightarrow{g_r} & B_{r+1} \\ \downarrow f_r & & \downarrow f_{r+1} \\ BO(r) & \xrightarrow{i_r} & BO(r+1) \end{array}$$

commutes, where $i_r : BO(r) \hookrightarrow BO(r+1)$ is the inclusion defined in Section 4.3. In this way, a (B_r, f_r) -structure on the normal bundle of an embedding of M in \mathbb{R}^{n+r} defines a unique (B_{r+1}, f_{r+1}) -structure on the normal bundle of the embedding of M in \mathbb{R}^{n+r+1} via the inclusion $\mathbb{R}^{n+r} \hookrightarrow \mathbb{R}^{n+r+1}$. This lead us to the following definition.

Definition 5.1.7. A (B, f) structure on an n -dimensional manifold M is an equivalence class of (B, f) sequences of (B_r, f_r) structures on the normal bundle of M , where two structure are equivalent if they agree for some sufficiently large r .

A manifold with such a structure is called a (B, f) manifold.

We can take the direct limit as $r \rightarrow \infty$, and hence describe a (B, f) structure as a structure on the stable normal bundle.

Proposition 5.1.8. *Let M be an n -dimensional (B, f) manifold. Then the (B, f) structure on M induces a (B, f) structure on the boundary ∂M .*

Proof. Let $i : M \rightarrow \mathbb{R}^{n+r}$ be an embedding, with normal bundle classified by $\nu(i) : M \rightarrow BO(r)$, and suppose r sufficiently large that any normal bundle of another embedding into \mathbb{R}^{n+r} is isomorphic to the normal bundle of i . Consider the embedding of $\partial M \rightarrow M$; its normal bundle is a trivial

line bundle, with two choices of global trivialisation, namely, the inner and outer normal vector fields. A choice of trivialisation allows us to view M as embedded in \mathbb{R}^{n+r-1} , with normal bundle classified by $\nu(i)|_{\partial M}$. Hence if $\tilde{\nu}(i) : M \rightarrow B_r$ is a lift of $\nu(i)$, we have a corresponding lift for the normal bundle of the boundary ∂M , namely $\tilde{\nu}(i)|_{\partial M} : \partial M \rightarrow B_r$. This defines a (B, f) structure on the boundary ∂M . \square

We give a few examples of (B, f) manifolds.

Example 5.1.9. The simplest example of a (B, f) structure is where the fibration is the trivial fibration $f_r : BO(r) \rightarrow BO(r)$. Hence (BO, f) manifolds are just smooth unoriented manifolds.

The fibration defined in Theorem 4.1.5 gives us more interesting examples.

Example 5.1.10. Consider the fibration $BSO(r) \rightarrow BO(r)$, where $SO(r) \subset O(r)$ is the special orthogonal group. This characterises manifolds with an orientation on their stable normal bundles. Since an unoriented bundle plus an oriented bundle is an unoriented bundle, and trivial bundles are orientable, the stable tangent bundle is oriented if and only if the tangent bundle is oriented. Hence (BSO, f) manifolds are oriented manifolds.

Example 5.1.11. Consider the fibrations $BU(r) \rightarrow BO(2r), BU(r) \rightarrow BU(2r+1)$, where $U(r) \subset O(2r) \subset O(2r+1)$ is the unitary group. This characterises manifolds with a complex structure on their stable normal bundles, which gives a complex structure on their stable tangent bundles. Hence (BU, f) manifolds are stably complex manifolds, and these are the manifolds we are working with.

5.2 Cobordism groups

We motivate the definition of the cobordism relation using the definition in the simplest case, that of unoriented manifolds.

Definition 5.2.1. Two compact manifolds M_1, M_2 of dimension n are said to be *unoriented cobordant*, or simply *cobordant*, if there exists an $(n+1)$ -dimensional manifold W and embeddings $i_1 : M_1 \rightarrow W, i_2 : M_2 \rightarrow W$ such that $\partial W = i_1(M_1) \sqcup i_2(M_2)$.

We call the quintuple (W, M_1, M_2, i_1, i_2) a *cobordism* between M_1 and M_2 .

This is often stated less formally by saying that the boundary of W is the disjoint unions of M_1 and M_2 , and written $\partial W = M_1 \sqcup M_2$.

Proposition 5.2.2. *The cobordism relation is an equivalence relation.*

Proof. We write \sim for the cobordism relation, to simplify notation.

The manifold $M \times [0, 1]$ has boundary $M \sqcup M$, so that $M \sim M$ and the relation is reflexive.

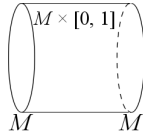

Figure 5.1: Reflexivity of \sim

If $M_1 \sim M_2$, then, for some manifold W , $\partial W = M_1 \sqcup M_2 = M_2 \sqcup M_1$, so that $M_2 \sim M_1$ and the relation is reflexive.

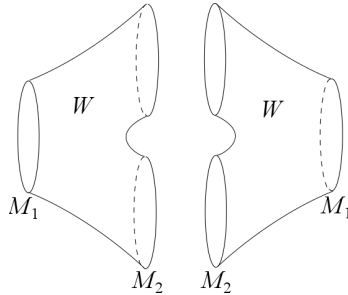

Figure 5.2: Symmetry of \sim

If $M_1 \sim M_2$, and $M_2 \sim M_3$, let W_1, W_2 be the cobordisms between them. Glue W_1, W_2 together along M_2 , using collar neighbourhoods of M_2 in W_1, W_2 to ensure the join is smooth, to obtain a third manifold W_3 , whose boundary is $M_1 \sqcup M_3$. Hence $M_1 \sim M_3$ and the relation is transitive.

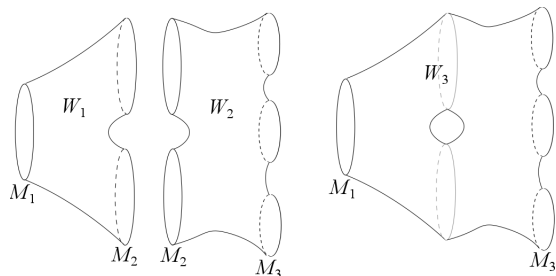

Figure 5.3: Transitivity of \sim

Hence cobordism is an equivalence relation. \square

The difficulty for a general (B, f) manifold M is that when we construct a (B, f) structure on $M \times [0, 1]$, the (B, f) structures induced on the two boundary components, $M = M \times 0$ and $M = M \times 1$, do not necessarily match. We need to be able to define an opposite structure of a given (B, f) structure, which we construct as follows.

Let i be an embedding of M in \mathbb{R}^{n+r} , for some sufficiently large r , with $\nu(i) : M \rightarrow B_r$ the lift to B_r of the classifying map of the normal bundle of the embedding i . We can extend this to an embedding j of $M \times [0, 1]$ in \mathbb{R}^{n+r+1} through the usual embedding of $[0, 1]$ in \mathbb{R} , which will not change the normal bundle, since $[0, 1]$ has zero normal bundle in \mathbb{R} . Then $\nu(j)$ is $M \times [0, 1]$ is then $\nu(i)$ composed with the the projection $M \times [0, 1] \rightarrow M$. Hence the lift of $\nu(i)$ to B_r gives a lift of $\nu(j)$, which induces a (B, f) structure on $M \times [0, 1]$, which in turn, via the inner normal trivialisaton on each component of the boundary induces the given (B, f) structure on $M = M \times 0$ and another, possibly different, on $M = M \times 1$. Since we use the inner normal on both components of the boundary, we can view $M \times 1$ as having an opposite (B, f) structure from $M \times 0$. Let \overline{M} be the manifold $M = M \times 1$ with this second (B, f) structure. Note that reversing the interval $[0, 1]$ gives us $\overline{\overline{M}} = M$.

In the case of unoriented manifolds, we simply have $M = \overline{M}$. In the case of oriented manifolds, $B = BSO$, \overline{M} is M with the reverse orientation. In the case of stably complex manifolds, $B = BU$, \overline{M} is M with the conjugate stable complex structure.

We can now define the cobordism relation for all (B, f) manifolds.

Definition 5.2.3. Two compact (B, f) manifolds M_1, M_2 of dimension n are said to be (B, f) cobordant if there exists an $(n + 1)$ -dimensional manifold W and embeddings $i_1 : M_1 \rightarrow W$ such that $\partial W = i_1(M_1) \sqcup (M_2)$, where the

(B, f) structure on W induces the (B, f) structures M_1, \overline{M}_2 at the boundary via the inner normal trivialisation.

We call the quintuple (W, M_1, M_2, i_1, i_2) a (B, f) cobordism between M_1 and M_2 .

This is often expressed less formally as $\partial W = M_1 \sqcup \overline{M}_2$, similarly to the unoriented case.

Proposition 5.2.4. *The (B, f) cobordism relation is an equivalence relation.*

Proof. By definition, $\partial(M \times [0, 1]) = M \sqcup \overline{M}$, so that $M \sim M$ and the relation is reflexive.

Suppose $M_1 \sim M_2$. Let W be the (B, f) cobordism between them. so that $\partial W = M_1 \sqcup \overline{M}_2$. Then $\partial \overline{W} = \overline{M}_1 \sqcup \overline{\overline{M}_2} = \overline{M}_1 \sqcup M_2 = M_2 \sqcup \overline{M}_1$. So \overline{W} is a (B, f) cobordism between M_2 and M_1 , so that $M_2 \sim M_1$ and the relation is reflexive.

Suppose $M_1 \sim M_2$ and $M_2 \sim M_3$. Let W_1, W_2 be the (B, f) cobordisms between M_1, M_2 and M_2, M_3 respectively. We can glue W_1, W_2 together along M_2 to obtain a manifold W_3 as in the unoriented case. We can also glue the (B, f) structures together, since if W_1 induces the structure \overline{M}_2 via the inner normal trivialisation of $M_2 \subset W_1$, it will induce the given structure M_2 via the outer normal trivialisation of $M_2 \subset W_1$, which is the same as the inner normal trivialisation of $M_2 \subset W_2$, so the (B, f) structure can be smoothly joined at the boundary M_2 of W_1 and W_2 . The resulting manifold W_3 satisfies $\partial W_3 = M_1 \sqcup \overline{M}_3$, so that $M_1 \sim M_3$ and the relation is transitive.

Hence (B, f) cobordism is an equivalence relation. \square

If $[M] = [\emptyset]$, we say that M is *nullcobordant*. If M is nullcobordant, it is the boundary of a (B, f) -manifold, of 1 dimension higher than M , that induces the given (B, f) structure on M . We call such a manifold a (B, f) *filling*. We call the equivalence classes under the cobordism relation *cobordism classes*. The set of (B, f) cobordism classes in dimension n is denoted $\Omega_n(B, f)$, and the set of all (B, f) cobordism classes is denoted $\Omega(B, f) = \bigoplus_{n=0}^{\infty} \Omega_n(B, f)$. Often, B_r is a sequence of classifying spaces for a sequence of topological groups G_r , with a sequence of inclusions $G_r \subset G_{r+1}$, leading to a stable group $G = \lim r \rightarrow \infty$. In this case, $\Omega_n(BG, f)$ is denoted Ω_n^G , and $\Omega(B, f)$ is denoted Ω^G .

Proposition 5.2.5. *The set $\Omega_n(B, f)$ of (B, f) cobordism classes in dimension n is an abelian group under the operation $[M_1] + [M_2] = [M_1 \sqcup M_2]$, with identity $[\emptyset]$, the class of the empty manifold.*

Proof. Clearly the disjoint union of two n -dimensional (B, f) manifolds is another n -dimensional (B, f) manifold, so that $\Omega_n(B, f)$ is closed under this operation.

The operation is associative and commutative, since the disjoint union is associative and commutative.

Clearly $[M] + [\emptyset] = [M \sqcup \emptyset] = [M]$, so there is a well defined identity element, $[\emptyset]$. In particular, if $M = \partial W$ for some (B, f) manifold W that induces the given (B, f) structure on M , then $[M] = [\emptyset]$.

We have, by definition, $\partial(M \times [0, 1]) = M \sqcup \overline{M}$. Hence $[M] + [\overline{M}] = [M \sqcup \overline{M}] = [\emptyset]$, so we have a well defined inverse $[\overline{M}]$ for $[M]$.

Hence $\Omega_n(B, f)$ is an abelian group. □

We return to the examples of (B, f) structures discussed in Section 5.1.

Example 5.2.6. The simplest example of (B, f) cobordism, where $f_r : B_r = BO(r) \rightarrow BO(r)$ is trivial, gives us cobordisms between smooth manifolds with no additional structure. The cobordism groups are called the unoriented cobordism groups, and are denoted Ω_n^O , or, more often, \mathfrak{N}_n .

Note that in the unoriented case, since there is no additional structure, the fact that $\partial(M \times [0, 1]) = M \sqcup M$ gives $[M] + [M] = [\emptyset]$, so that all the cobordism groups \mathfrak{N}_n are 2-torsion.

Example 5.2.7. The second example we gave was the fibration $BSO(r) \rightarrow BO(r)$, which gives us cobordism groups of oriented manifolds, denoted Ω_n^{SO} .

Example 5.2.8. The third example we gave was the fibration $BU(r) \rightarrow BO(2r), BO(2r + 1)$, which gives us cobordism groups of stably complex manifolds, denoted Ω_n^U . These are the groups we are interested in.

As an aside, we note that we can also define a product of cobordism classes, $\times : \Omega_{n_1}(B, f) \times \Omega_{n_2}(B, f) \rightarrow \Omega_{n_1+n_2}(B, f)$, $[M_1] \times [M_2] = [M_1 \times M_2]$. Under this definition, $\Omega(B, f)$ becomes a graded commutative ring, which is denoted $\Omega_*(B, f)$, Ω_*^G , or \mathfrak{N}_* , depending on context. However, this extra structure is unnecessary for our purpose.

5.3 Thom spaces

Definition 5.3.1. A *compactification* of a topological space X is a compact space that contains an embedding of X as a dense subset.

Definition 5.3.2. Let X be a topological space. We define the *one-point compactification* Y of X as follows. Take the disjoint union of X with a single point, which we call ∞ . Define a topology on $X \sqcup \{\infty\}$, consisting of all open set of X and the disjoint union of every complement of every compact set of X with $\{\infty\}$, that is, the topology τ_Y on Y is given by

$$\tau_Y = \{U \subset X : U \text{ open}\} \cup \{X \setminus K \sqcup \infty : K \text{ compact}\}.$$

Proposition 5.3.3. *The one-point compactification of X is a compactification.*

Proof. Clearly X is a dense subset of its one-point compactification Y , since the only point in $Y \setminus X$ is ∞ .

Let $\{U_i\}$ be an open cover of Y . One of the U_i must cover $\infty \in Y$, which, by definition of the topology on Y , is $X \setminus K \sqcup \{\infty\}$ for some compact $K \subset X$; call this set U_0 . We now have to find a finite subcover for $K = Y \setminus (X \setminus K \sqcup \{\infty\})$. Since $K \subset X \subset Y$ is compact in X , we can cover K by finitely many of the U_i , call these U_1, \dots, U_n . Hence we have a finite subcover $\{U_0, U_1, \dots, U_n\}$ for $U_0 \cup K = (X \setminus K \sqcup \{\infty\}) \cup K = X \sqcup \infty = Y$, so that Y is compact. \square

Definition 5.3.4. Let $E \rightarrow B$ be a vector bundle. We define a new bundle by taking the one-point compactification of each fibre. We define the *Thom Space* of E by identifying all of the new points of this new bundle to a single point, which we call ∞ , and denote this space with basepoint (TE, ∞) , or TE .

An equivalent formulation takes the set of all vectors in the total space of norm ≤ 1 , which is the *closed disc bundle* $D(E)$ associated with the vector bundle, and identifies the boundaries of all of the fibres, which is the *sphere bundle* $Sph(E)$, to a single point, so that $TE = D(E)/Sph(E)$. That this is equivalent follows from introducing an intermediate step, identifying the boundary of each fibre of the disc bundle to a point, to obtain the one-point compactification of the open discs, or, equivalently, of the original spaces, and identifying all of these points to a single point.

If we have a bundle map $g : X \rightarrow Y$ such that $E \rightarrow X$ is the pullback g^*E of a bundle $E' \rightarrow Y$, we see that g induces a map Tg via the construction of Thom spaces, $Tg : (TE, \infty) \rightarrow (TE', \infty)$.

Now suppose we have a vector bundle $E \rightarrow B$ of rank n , with Thom space TE , and we add a trivial line bundle $\underline{\mathbb{R}}$. We will use the product norm on

$E \oplus \underline{\mathbb{R}}$, as this will be simpler and it does not change the spaces topologically. Let D denote the unit disc in E , which is the total space of the disc bundle $D(E)$. We form the disc bundle, which is $D \times [-1, 1]$, and take the quotient by identifying the boundary $(\partial D \times [-1, 1]) \cup D \times \{-1, 1\}$ to a point, so that

$$T(E \oplus \underline{\mathbb{R}}) = (D \times [-1, 1]) / ((\partial D \times [-1, 1]) \cup (D \times \{-1, 1\})).$$

Equivalently, by first identifying ∂D to a point, and then identifying $\partial[-1, 1]$ to a point, we see that

$$\begin{aligned} T(E \oplus \underline{\mathbb{R}}) &= (D/\partial D \times [-1, 1]) / (D/\partial D \times \{-1, 1\}) \\ &= (T(E) \times [-1, 1]) / (T(E) \times \{0, 1\}). \end{aligned}$$

To understand this space, we need the following definition.

Definition 5.3.5. Let X be a topological space. Define the *suspension* of X ,

$$SX = (X \times [0, 1]) / (X \times \{0, 1\})$$

If, in addition, X has a basepoint x_0 , define the *reduced suspension* of X ,

$$\Sigma X = (X \times [0, 1]) / (X \times \{0, 1\} \cup x_0 \times [0, 1]).$$

We can therefore identify $T(E \oplus \underline{\mathbb{R}})$ as $ST(E)$. We will need two facts concerning these constructions. The first is that if X is a CW-complex, SX and ΣX are homotopy equivalent, so without loss of generality, since all the spaces we are working with are CW-complexes, we will use the reduced suspension Σ , so $T(E \oplus \underline{\mathbb{R}}) = \Sigma T(E)$. The second is a well-known theorem.

Theorem 5.3.6. *Let X be an n -connected CW-complex. Then $\pi_k X \cong \pi_{k+1} \Sigma X$ for $k \leq 2n$.*

This is a consequence of the *Freudenthal suspension theorem*, which is stated and proven in [5].

Recall we had a commutative diagram for (B, f) structures,

$$\begin{array}{ccc} B_r & \xrightarrow{g_r} & B_{r+1} \\ \downarrow f_r & & \downarrow f_{r+1} \\ BO(r) & \xleftarrow{i_r} & BO(r+1). \end{array}$$

Using the results above, we can apply the Thom construction to this diagram, writing $TBO(r)$ for $T\gamma^r$, and TB_r for $Tf^*\gamma_r$. Then we have the commutative diagram

$$\begin{array}{ccc} \Sigma TB_r & \xrightarrow{Tg_r} & TB_{r+1} \\ \downarrow \Sigma Tf_r & & \downarrow Tf_{r+1} \\ \Sigma TBO(r) & \xrightarrow{i_r} & TBO(r+1), \end{array}$$

since the inclusion $BO(r) \hookrightarrow BO(r+1)$ induces the bundle $\gamma^n \oplus \mathbb{R}$ over $BO(r)$. In particular, we have an inclusion map $Tg_r : \Sigma TB_r \rightarrow TB_{r+1}$, which means that the sequence TB_1, TB_2, \dots has a special property.

Definition 5.3.7. A *spectrum* is a sequence $X = \{X_n\}_{n \in \mathbb{N}}$ of spaces with basepoint, with an inclusion map $\Sigma X_n \rightarrow X_{n+1}$.

If the spaces X_n are CW-complexes, and the inclusion maps are inclusions of subcomplexes, this is called a *CW-spectrum*.

The only property we need, as a corollary of the Freudenthal suspension theorem, is that the homotopy groups stabilise, so we can define $\pi_k X = \lim_{n \rightarrow \infty} \pi_{k+n} X_n$. We can therefore define the Thom spectrum TB from the sequence TB_r , with stable homotopy groups $\pi_n TB = \lim_{r \rightarrow \infty} \pi_{n+r} TB_r$. When $B = BG$, we normally denote the Thom spaces by $MG(r)$ rather than by $TBG(r)$, and the Thom spectrum by MG .

We can now state the central theorem of (B, f) cobordism.

Theorem 5.3.8 (Thom-Pontryagin theorem). *There is an isomorphism*

$$\Omega_n(B, f) \cong \pi_n TB \cong \lim_{r \rightarrow \infty} \pi_{n+r}(TB_r, \infty).$$

Proof. The theorem is proven in [12]. □

We have reduced the cobordism problem to a homotopy problem. It is possible to define a multiplicative structure on TB , making it a *ring spectrum* with $\Omega_*(B, f) \cong \pi_* TB$. However, this additional structure is unnecessary for our purpose.

We can now apply the Thom-Pontryagin theorem to complex cobordism.

Theorem 5.3.9. *The cobordism groups Ω_n^U are trivial for n odd.*

Proof. By Theorem 5.3.8, $\Omega_n^U \cong \pi_n MU$. Milnor proved in [9] that the groups $\pi_n MU$ are trivial for n odd. \square

Corollary 5.3.9.1. *Let M be a $(2n-1)$ -dimensional contact manifold. Then M is the boundary of a $(2n)$ -dimensional stably complex manifold W .*

Proof. By Theorem 5.3.9, the complex cobordism groups are trivial in odd dimension. This gives $[M] = [\emptyset]$ in Ω_{2n-1}^U , so that there exists a $(2n)$ -dimensional stably complex manifold W with $\partial W = M \sqcup \emptyset = M$. \square

Chapter 6

Obstruction theory

6.1 Problems of obstruction theory

Here we give a brief overview of the problems and obstructions that obstruction theory deals with, which we will use to show that the manifold W admits not just a stably complex structure, but an almost complex structure. A fuller treatment is given in Chapter 7 of [7].

The main problem of obstruction theory can be described as follows. Let X be a CW-complex, $A \subset X$ a subcomplex, $i : A \rightarrow X$ inclusion, $p : E \rightarrow B$ a fibration, $f : X \rightarrow B$ a continuous map, and $\tilde{f}_A : A \rightarrow E$ such that the diagram

$$\begin{array}{ccc} A & \xrightarrow{\tilde{f}_A} & E \\ \downarrow i & & \downarrow p \\ X & \xrightarrow{f} & B \end{array}$$

commutes. The problem, known as the *relative lifting problem*, is to find a map $\tilde{f} : X \rightarrow E$ such that the diagram

$$\begin{array}{ccc} A & \xrightarrow{\tilde{f}_A} & E \\ \downarrow i & \nearrow \tilde{f} & \downarrow p \\ X & \xrightarrow{f} & B \end{array}$$

commutes.

The problems dealt with in obstruction theory are special cases of the relative lifting problem.

The first is the *extension problem*. This is where B is trivial. We want to find $\tilde{f} : X \rightarrow E$ such that the diagram

$$\begin{array}{ccc} A & \xrightarrow{f} & E \\ \downarrow & \nearrow \tilde{f} & \\ X & & \end{array}$$

commutes.

An important special case of the extension problem is the *homotopy problem*. This is the problem of extending a homotopy f_t on A between two maps $f_0, f_1 : X \rightarrow Y$ to a homotopy \tilde{f}_t on X ; equivalently, of finding \tilde{f}_t such that the diagram

$$\begin{array}{ccc} X \times \{0, 1\} \cup A \times [0, 1] & \xrightarrow{f_t} & E \\ \downarrow & \nearrow \tilde{f}_t & \\ X \times [0, 1] & & \end{array}$$

commutes.

The second problem is the *lifting problem*. This is where A is trivial. This is the problem of find \tilde{f} such that the diagram

$$\begin{array}{ccc} & & E \\ & \nearrow \tilde{f} & \downarrow p \\ X & \xrightarrow{f} & B \end{array}$$

commutes.

A special case of the lifting problem is the *cross-section problem*, where $p : E \rightarrow B$ is a fibre bundle, $X = B$ and f is the identity map. This is just the problem of finding cross-sections of a bundle $p : E \rightarrow B$.

The method of obstruction theory is to solve the problem inductively cell-by-cell, skeleton-by-skeleton. Suppose the extension problem is solved over the n -skeleton of X , and let e^{n+1} be an $(n + 1)$ -cell in X . We have some map defined on ∂e^{n+1} that solves the problem, so we can solve the problem for e^{n+1} if we can extend this map over the cell. If we compose the map f with the embedding $S^n \rightarrow \partial e^{n+1} \rightarrow X_n$, where X_n is the n -skeleton of X , we

obtain an element of $\pi_n(E)$. If this homotopy group is trivial, then we can extend the map over the $(n + 1)$ -cell e^{n+1} , since the map $S^n \rightarrow \partial e^{n+1} \rightarrow E$ is homotopic to the constant map.

For the lifting problem, we have a similar situation. For a fibration $E \rightarrow B$ with fibre F , a lift from B to E is equivalent to a map into the fibre F . If the homotopy groups $\pi_k F$ of F are trivial for $k < \dim X$, then the lifting problem can be solved, as in the extension problem. It turns out that all the homotopy groups involved in the problems we will look at will be trivial, so that the problems can be solved easily. For the sake of completeness, we state the main theorems of obstruction theory here; these can be found, with proofs, in [7].

Theorem 6.1.1. *Let X be a CW-complex, $A \subset X$ a subcomplex. Suppose that $f : A \rightarrow E$ is a continuous map, where E is n -simple, and f has been extended to the n -skeleton $X^{(n)}$ of X . Then*

1. *There exists a cellular cocycle $\theta(f) \in C^{n+1}(X, A, \pi_n E)$ which vanishes if and only if the map can be extended to a map $X^{(n+1)} \rightarrow E$.*
2. *The cohomology class $[\theta(f)] \in H^{n+1}(X, A, \pi_n E)$ vanishes if and only if the restriction $f|_{X^{(n-1)}} : X^{(n-1)} \rightarrow E$ can be extended to the a map $X^{(n+1)} \rightarrow E$.*

Theorem 6.1.2. *Let X be a CW-complex, $p : E \rightarrow B$ a fibration with fibre F that is n -simple. Let $f : X \rightarrow B$ be a continuous map with a lift of f to the n -skeleton. Then there is a local coefficient system ρ such that we can define an obstruction class $[\theta(f)] \in H^{n+1}(X, \pi_n F_\rho)$. Moreover, if $[\theta(f)]$ is trivial, then f can be redefined on $X^{(n-1)}$ and then lifted to $X^{(n+1)}$.*

In the cases we will work with, F has trivial homotopy groups up to n , so we will be able to conclude that the lifts we are looking for exist without having to compute cohomology groups.

6.2 Applying obstruction theory

Recall that we have proven that if M is a $(2n - 1)$ -dimensional contact manifold, it is the boundary of a $(2n)$ -dimensional stably complex manifold W , so there exists a lift of the classifying map $W \rightarrow BO$ for the stable tangent bundle to BU . We now show that this map can be lifted to $BU(n)$, so that

the stable complex structure on W induces a complex bundle of complex rank n and so of real rank $2n$, and show that this is equivalent to the tangent bundle in the sense of real vector bundles.

By Theorem 4.1.5, we have a fibration $U/U(n) \rightarrow BU(n) \rightarrow BU$. The stable complex structure induces a complex bundle of rank n if and only if the classifying map of the stable tangent bundle, $W \rightarrow BU$, admits a lift to $BU(n)$. Obstruction theory tells us that if the homotopy groups $\pi_k U/U(n)$ are trivial for $k \leq 2n-1$, a lift will exist. We turn our attention to computing these groups.

Lemma 6.2.1. *There exists a fibre bundle*

$$U(n) \xrightarrow{i_n} U(n+1) \xrightarrow{p_n} S^{2n+1}. \quad (6.1)$$

Proof. Fix a point $x_0 \in S^{2n+1} \subset \mathbb{C}^{n+1}$. Define $p_n : U(n+1) \rightarrow S^{2n+1}$, $p(A) = Ax_0$. Since A is unitary, it is orthogonal in the real sense, so we have $Ax_0 \in S^{2n+1}$, so that p_n is well defined. Let x be a point in S^{2n+1} and suppose that $Ax_0 = x$ and $Bx_0 = x$ for two matrices $A, B \in U(n+1)$; since A is invertible, we have $B = (BA^{-1})A$, so that $BA^{-1}(x) = x$. So $p_n^{-1}(x)$, the set of matrices that map x_0 to x , is then the set of matrices CA such that C is a matrix in $U(n+1)$ that preserves x , which is homeomorphic to $U(n)$, seen as a subset of $U(n+1)$. \square

This induces a long exact sequence

$$\dots \rightarrow \pi_{k+1} S^{2n+1} \rightarrow \pi_k U(n) \xrightarrow{i_{n*}} \pi_k U(n+1) \xrightarrow{p_{n*}} \pi_k S^{2n+1} \rightarrow \dots \rightarrow \pi_0 S^{2n+1}. \quad (6.2)$$

We know that $\pi_k S^j = 0$ for all $k < j$, so, for $k < 2n$ this gives the exact sequence

$$0 \rightarrow \pi_k U(n) \xrightarrow{i_{n*}} \pi_k U(n+1) \rightarrow 0. \quad (6.3)$$

Hence the map $i_{n*} : \pi_k U(n) \rightarrow \pi_k U(n+1)$ induced by the inclusion map is an isomorphism for $k < 2n$, so we have, for $n > k/2$,

$$\pi_k U(n) \cong \pi_k U(n+1) \cong \pi_k U(n+2) \cong \dots \cong \pi_k U. \quad (6.4)$$

In particular, by composing the inclusion maps, we also see that the inclusion $i : U(n) \hookrightarrow U$ induces isomorphisms $i_* : \pi_k U(n) \rightarrow \pi_k U$ for $k < 2n$.

We can now define a second fibre bundle. Let $p : U \rightarrow U/U(n)$ be projection. Let $x \in U/U(n)$, $x' \in U$ such that $p(x') = x$. Then the fibre

$p^{-1}(x)$ is a coset $xU(n)$, which is homeomorphic to $U(n)$. So we have a fibre bundle $U(n) \xrightarrow{i} U \xrightarrow{p} U/U(n)$ where i is inclusion. This induces a long exact sequence of homotopy groups as usual, so we have the exact sequence

$$\begin{aligned} \dots \pi_{k+1}U &\rightarrow \pi_{k+1}U/U(n) \rightarrow \pi_k U(n) \\ &\xrightarrow{i_*} \pi_k U \rightarrow \pi_k U/U(n) \rightarrow \pi_{k-1}U(n) \dots \end{aligned} \quad (6.5)$$

We know from (6.4) that, for $k < 2n$, i_* induces an isomorphism $\pi_k U(n) \cong \pi_k U$. We then have, for $k < 2n$, the exact sequences

$$\pi_k U(n) \xrightarrow[\cong]{i_*} \pi_k U \rightarrow \pi_k U/U(n) \rightarrow \pi_{k-1}U(n) \xrightarrow[\cong]{i_*} \pi_{k-1}U. \quad (6.6)$$

This easily gives us $\pi_k U/U(n) = 0$ for $k < 2n$. Hence there exists a lift of the classifying map of the stable tangent bundle $W \rightarrow BU$ to a map $W \rightarrow BU(n)$, which means that the stable complex structure induces a complex vector bundle, which we will call E , of rank n over W , as required. We still need to prove that this is, in fact, the tangent bundle TW . We have two vector bundles, E, TW over W , both of rank $2n$. Both have the same stable classifying map $W \rightarrow BU$, and composing with the projection $BU \rightarrow BO$ gives us the same stable classifying map $W \rightarrow BO$, so that the two bundles are stably equivalent.

We claim that two stably equivalent vector bundles of rank r over an n -dimensional CW-complex X are equivalent if $r > n$. Since the bundles are stably equivalent, they have homotopic stable classifying maps $X \rightarrow BO$. By Theorem 4.1.5, we have a fibration $O/O(r) \rightarrow BO(r) \rightarrow BO$. Obstruction theory tells us that the obstructions to lifting the homotopy $X \times [0, 1] \rightarrow BO$ from BO to $BO(r)$ lie in the homotopy groups $\pi_k O/O(r)$ for $0 \leq k \leq n$. We now compute these homotopy groups.

Lemma 6.2.2. *There exists a fibre bundle*

$$O(r) \xrightarrow{i_r} O(r+1) \xrightarrow{p_r} S^r. \quad (6.7)$$

Proof. Fix a point $x_0 \in S^r \subset \mathbb{R}^{r+1}$. Define $p_r : O(r+1) \rightarrow S^r, p_r(A) = Ax_0$. Since A is orthogonal, we have $Ax_0 \in S^r$, so that p_r is well defined. Let x be a point in S^r and suppose that $Ax_0 = x$ and $Bx_0 = x$ for two matrices $A, B \in O(r+1)$; since A is invertible, we have $B = (BA^{-1})A$, so that $BA^{-1}(x) = x$. So $p_r^{-1}(x)$, the set of matrices that map x_0 to x , is then the set of matrices CA such that C is a matrix in $O(r+1)$ that preserves x , which is homeomorphic to $O(r)$, seen as a subset of $O(r+1)$. \square

This induces a long exact sequence

$$\dots \rightarrow \pi_{k+1}S^r \rightarrow \pi_k O(r) \xrightarrow{i_{r*}} \pi_k O(r+1) \xrightarrow{p_{r*}} \pi_k S^r \rightarrow \dots \rightarrow \pi_0 S^r. \quad (6.8)$$

We know that $\pi_k S^j = 0$ for all $k < j$, so, for $k < r - 1$ this gives the exact sequence

$$0 \rightarrow \pi_k O(r) \xrightarrow{i_{r*}} \pi_k O(r+1) \rightarrow 0, \quad (6.9)$$

and the exact sequence

$$\pi_{r-1} O(r) \xrightarrow{i_{r*}} \pi_k O(r+1) \rightarrow 0. \quad (6.10)$$

Hence the map $i_{r*} : \pi_k O(r) \rightarrow \pi_k O(r+1)$ induced by the inclusion map is an isomorphism for $k < r - 1$, and a surjection for $k = r - 1$, so we have, for $r > k + 1$,

$$\pi_k O(r) \cong \pi_k O(r+1) \cong \pi_k O(n+2) \cong \dots \cong \pi_k O. \quad (6.11)$$

In particular, by composing the inclusion maps, we also see that the inclusion $i : O(r) \hookrightarrow O$ induces isomorphisms $i_* : \pi_k O(r) \rightarrow \pi_k O$ for $k < r - 1$, and a surjection for $k = r - 1$.

We can now define a second fibre bundle. Let $p : O \rightarrow O/O(r)$ be projection. Let $x \in O/O(r), x' \in O$ such that $p(x') = x$. Then the fibre $p^{-1}(x)$ is a coset $xO(r)$, which is homeomorphic to $O(r)$. So we have a fibre bundle $O(r) \xrightarrow{i} O \xrightarrow{p} O/O(r)$ where i is inclusion. This induces a long exact sequence of homotopy groups as usual, so we have the exact sequence

$$\begin{aligned} \dots \pi_{k+1} O &\rightarrow \pi_{k+1} O/O(r) \rightarrow \pi_k O(r) \\ &\xrightarrow{i_*} \pi_k O \rightarrow \pi_k O/O(r) \rightarrow \pi_{k-1} O(r) \dots \end{aligned} \quad (6.12)$$

We know from (6.11) that, for $k < r - 1$, i_* induces an isomorphism $\pi_k O(r) \cong \pi_k O$. We then have, for $k < r - 1$, the exact sequences

$$\pi_k O(r) \xrightarrow[\cong]{i_*} \pi_k O \rightarrow \pi_k O/O(r) \rightarrow \pi_{k-1} O(r) \xrightarrow[\cong]{i_*} \pi_{k-1} O. \quad (6.13)$$

This easily gives us $\pi_k O/O(r) = 0$ for $k < r - 1$. Moreover, we have the exact sequence

$$\pi_{r-1} O(r) \xrightarrow[\cong]{i_*} \pi_{r-1} O \rightarrow \pi_{r-1} O/O(r) \rightarrow \pi_{r-2} O(r) \xrightarrow[\cong]{i_*} \pi_{r-2} O. \quad (6.14)$$

The first i_* is surjective, and the second is an isomorphism, so that we have $\pi_{r-1}O/O(r) = 0$ as well.

Hence, if $\dim X = n < r$, we have $\pi_k O/O(r) = 0$ for $k \leq n - 1$, so the homotopy of the classifying maps in BO can be lifted to $BO(r)$, so the two bundles are equivalent. This proves our claim.

A manifold is called *open* if none of its connected components are closed. From 4.3.1 in [2], for every open manifold V , there exists a polyhedron K of codimension at least 1 such that there is an isotopy compressing the open manifold into an arbitrarily small neighbourhood of K . Hence every open manifold of dimension n admits a deformation retraction onto a subset of its $(n - 1)$ -skeleton. Now W , as a manifold with boundary, is an open manifold, and so deformation retracts to a $(2n - 1)$ -complex. Applying the claim to the bundles TW, E over W , which have rank $2n$, we deduce that $TW \cong E$. The homotopy lifting property of the fibration $U(n) \rightarrow O(2n)$ then implies that TW is also a complex vector bundle, so that W is an almost complex manifold.

The almost complex structure on W induces an almost contact structure on the boundary M as follows. Since TM is a subbundle of rank $2n - 1$ of TW on M , which is a complex bundle, its structure group can be reduced to $U(n) \cap O(2n - 1) = U(n - 1)$. We have the almost contact structure on M that we started with, and the almost contact structure induced by the almost complex structure on W . These two structures are stably equivalent to the stably complex tangent bundle, since both have the same stably complex filling. Hence, by the same argument as above, the two bundles, and hence the two almost contact structures, must be equivalent on the $(2n - 2)$ -skeleton of M . Now M is a closed manifold, so it does not retract in the same way as W . However, if we remove the interior of an open disc D^{2n-1} in M , we obtain a manifold with boundary, which is an open manifold and so deformation retracts onto a $(2n - 2)$ -complex. Hence up to homotopy, the almost contact structure on M and the almost contact structure induced by the W are the same, outside the interior of some disc $D^{2n-1} \subset M$.

In the next chapter, we will develop a method for changing the almost contact structure on the interior of a suitably chosen disc in M so that it is homotopic to the original almost contact structure, so that the manifold M admits an almost complex filling, that is, an almost complex manifold with boundary M such that the almost complex structure induces the given almost contact structure on M up to homotopy.

Chapter 7

Contact Surgery

7.1 Surgery

Recall that for the product of topological manifolds $X \times Y$, we have the boundary $\partial(X \times Y) = (\partial X \times Y) \cup (X \times \partial Y)$. In particular, we have $\partial(S^i \times D^{j+1}) = \partial(D^{i+1} \times S^j) = S^i \times S^j$.

Definition 7.1.1. Let M be an n -dimensional manifold, and suppose that S^k is embedded in M , with the normal bundle of the embedding trivialised, so that there is an embedding of $S^k \times D^{n-k}$ in M .

We form a new manifold M' of the same dimension by removing $S^k \times \text{int } D^{n-k}$ and attaching $D^{k+1} \times S^{n-k-1}$ by gluing along the resulting common boundary $S^k \times S^{n-k-1}$, so that

$$M' = (M \setminus S^k \times \text{int } D^{n-k}) \cup_{S^k \times S^{n-k-1}} (D^{k+1} \times S^{n-k-1}).$$

We call this process a *surgery* of M along S^k , and call the new manifold M' the *surgered manifold*.

We can do this smoothly by taking collar neighbourhoods of the boundary $S^k \times S^{n-k-1}$ in both $M \setminus S^k \times \text{int } D^{n-k}$ and $D^{k+1} \times S^{n-k-1}$, and identifying these neighbourhoods via a diffeomorphism. By definition, the surgered manifold M' is determined by the choice of embedding $S^k \times D^{n-k} \rightarrow M$, equivalently, by the choice of trivialisation of the normal bundle of $S^k \subset M$. To make explicit reference to the embedding, we can write, for an embedding $\phi : S^k \times D^{n-k} \rightarrow M$

$$M' = (M \setminus \text{int } \phi(S^k \times D^{n-k})) \cup_{\phi|_{S^k \times S^{n-k}}} (D^{k+1} \times S^{n-k-1}).$$

Note that we can reverse the process using a surgery of M' along S^{n-k-1} . We now define the related process of handle attachment.

Definition 7.1.2. Let $(W, \partial W)$ be an $(n+1)$ manifold with boundary, and suppose there is an embedding of S^k in ∂W with trivialised normal bundle, so that there is an embedding of $S^k \times D^{n-k}$ in ∂W .

We form a new manifold with boundary $(W', \partial W')$ of the same dimension by gluing $D^{k+1} \times D^{n-k}$ along $S^k \times D^{n-k}$, so that

$$(W, \partial W) = (W \cup_{S^k \times D^{n-k}} (D^{k+1} \times D^{n-k}), \\ (\partial W \setminus S^k \times \text{int } D^{n-k}) \cup_{S^k \times S^{n-k-1}} (D^{k+1} \times S^{n-k-1})).$$

The space W is not a smooth manifold, due to the corners where the handle meets the manifold at $S^k \times S^{n-k-1}$. Smoothing these corners completes the process.

We call this process *attaching a $(k+1)$ -handle* to $(W, \partial W)$, where the $(k+1)$ -handle is $D^{k+1} \times D^{n-k-1}$, and call $k+1$ the *index* of the handle.

Note that this defines a surgery of ∂W along $S^k \times D^{n-k}$, which motivates the following proposition.

Proposition 7.1.3. *For any surgery on M along $S^k \times D^{n-k} \subset M$, we can construct a handle attachment on a manifold $(W, \partial W)$ whose corresponding surgery on the boundary is the surgery on M .*

Proof. Let $W = M \times [0, 1]$, and attach a $(k+1)$ -handle to $M \times 1$ at $S^k \times D^{n-k} \subset M \times 1 \subset \partial W$. Then if the surgered manifold is M' , we have $M \times 1 = M'$, in other words, attaching the handle to W as described defines the given surgery on M at the boundary $M \times 1$. \square

Note that W is a cobordism between M and M' , specifically an unoriented cobordism.

We now give an explicit description of the process of smoothing corners for this case, following Milnor in [10]. Let M be an n -dimensional manifold, $\phi : S^k \times D^{n-k}$ a smooth embedding, and let $W = M \times [-1, 1]$. We could equivalently let $W = M \times [0, 1]$ as above, and as in Section 5.2, but this will simplify certain calculations later on.

Definition 7.1.4. We define the *handle H* as follows.

$$H := \{(x, y) \in \mathbb{R}^{k+1} \times \mathbb{R}^{n-k} : -1 \leq |x|^2 - |y|^2 \leq 1, |x||y| < \sinh 1 \cosh 1\}.$$

This is diffeomorphic to $D^{k+1} \times D^{n-k}$ with the corners removed. The removal of the corners corresponds to the second inequality, $|x||y| < \sinh 1 \cosh 1$. This inequality is chosen to make the computation of certain diffeomorphisms simpler.

We call the subset of H such that $|x|^2 - |y|^2 = 1$ the *upper boundary*, and the subset of H such that $|x|^2 - |y|^2 = -1$ the *lower boundary*. We denote these by $\partial^+ H, \partial^- H$ respectively. We call $D^{k+1} \times 0 \subset H$ the *core* of the handle, $0 \times D^{n-k} \subset H$ the *cocore* or *belt disc*, and $0 \times \partial D^{n-k} \cong S^{n-k-1}$ the *belt sphere*.

The handle H for the case $n = 1, k = 0$ is shown in Figure 7.1. In this case, the upper boundary consists of the curves bounding H from the top and bottom, and the lower boundary consists of the curves bounding H from the left and right.

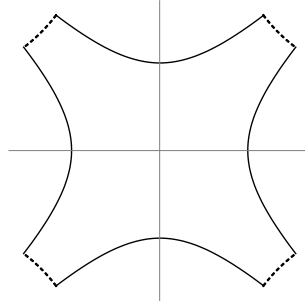

Figure 7.1: The handle H

Proposition 7.1.5. *The upper boundary*

$$\partial^+ H = \{(x, y) \in H : |x|^2 - |y|^2 = 1\}$$

is diffeomorphic to $S^k \times \text{int } D^{n-k}$.

Proof. Since $|x|^2 - |y|^2 = 1, |x||y| < 1$ on the upper boundary, we can parametrise by $(u \cosh r, v \sinh r)$, where $u \in S^k, v \in S^{n-k-1}, 0 \leq r < 1$. Hence we can write down a diffeomorphism

$$\begin{aligned} \partial^+ H &\longleftrightarrow S^k \times \text{int } D^{n-k} \\ (u \cosh r, v \sinh r) &\longleftrightarrow (u, rv). \end{aligned}$$

□

Proposition 7.1.6. *The lower boundary*

$$\partial^- H = \{(x, y) \in H : |x|^2 - |y|^2 = -1\}$$

is diffeomorphic to $\text{int } D^{k+1} \times S^{n-k-1}$.

Proof. Since $|x|^2 - |y|^2 = -1$, $|x||y| < 1$ on the lower boundary, we can parametrise by $(u \sinh r, v \cosh r)$, where u, v, r are as above. Hence we can write down a diffeomorphism

$$\begin{aligned} \partial^- H &\longleftrightarrow \text{int } D^{k+1} \times S^{n-k-1} \\ (u \sinh r, v \cosh r) &\longleftrightarrow (ru, v). \end{aligned}$$

□

The simple form of these diffeomorphisms is due to the choice of the inequality $|x||y| < \sinh 1 \cosh 1$ in the definition of H .

We now define a family of curves that will enable us to attach the handle smoothly. For $(x_0, y_0) \in H$, define the curve

$$\gamma : t \mapsto (tx_0, t^{-1}y_0), t \in \mathbb{R}^+.$$

This is a family of hyperbolas that satisfy $|x||y|$ constant, and intersect the level sets of $|x|^2 - |y|^2$ orthogonally. These curves will be important in smoothing the join between H and $M \times [-1, 1]$ at $\phi(S^k \times D^{n-k}) \subset M$.

We now use H to describe a handle attachment to $M \times [-1, 1]$ smoothly, and thereby describe the cobordism corresponding to a given surgery on M along $\phi(S^k \times D^{n-k})$. We begin with

$$(M \setminus \phi(S^k \times 0)) \times [-1, 1] \sqcup H.$$

We can parametrise $(M \setminus \phi(S^k \times 0)) \times [-1, 1]$ by $(\phi(u, rv), s)$ in a similar way to the above propositions, with $u \in S^k, v \in S^{n-k-1}, 0 < r < 1, -1 \leq s \leq 1$. We then form a quotient space W by identifying

$$(\phi(u, rv), s) \in (M \setminus \phi(S^k \times 0)) \times [-1, 1]$$

with $(x, y) \in H$ such that

1. $|y|^2 - |x|^2 = s$

2. $(x, y) \in \gamma$, where γ is the curve through $(u \cosh r, v \sinh r)$ defined above.

This correspondence defines a diffeomorphism

$$\phi(S^k \times \text{int } D^{n-k} \setminus 0) \times [-1, 1] \longleftrightarrow H \setminus 0,$$

so that W is a smooth manifold. The key to this process is that we have a neighbourhood of $S^k \subset M$ diffeomorphic to a neighbourhood of $\partial^+ H \subset H$, which allows us to attach the handle smoothly.

The boundary of W has two components, corresponding to $s = \pm 1$, equivalently, corresponding to the upper and lower boundaries $\partial^\pm H$. We will call them the upper and lower boundaries of W and denote them $\partial^+ W, \partial^- W$, as for H .

The upper boundary $\partial^+ W$ of W is diffeomorphic to the original manifold M , since $\partial^+ H$ is diffeomorphic to $S^k \times \text{int } D^{n-k}$. Explicitly, we can define a diffeomorphism

$$M \longleftrightarrow \partial^+ W$$

$$p \longleftrightarrow \begin{cases} (p, 1) \in (M \setminus \phi(S^k \times 0)) \times 1 & \text{for } p \in M \setminus \phi(S^k \times 0) \\ (u \cosh r, v \sinh r) \in \partial^+ H & \text{for } p = \phi(u, rv), \end{cases}$$

where $u \in S^k, v \in S^{n-k-1}, 0 \leq r < 1$ as usual. Both of the cases in the function given above are diffeomorphisms; the first is essentially the identity, and the second is the diffeomorphism between $\partial^+ H$ and $S^k \times \text{int } D^{n-k}$ composed with the smooth embedding ϕ . Using the identification in the definition of W , we see that both cases agree on $\phi(S^k \times \text{int } D^{n-k} \setminus 0)$, so that this is well defined, and so defines a diffeomorphism between M and $\partial^+ W$.

The surgered manifold M' can be described as a quotient space of

$$(M \setminus \phi(S^k \times 0)) \sqcup D^{k+1} \times S^{n-k-1},$$

by identifying $(ru, v) \in D^{k+1} \times S^{n-k-1}$ with $\phi(u, rv) \in \phi(S^k \times \text{int } D^{n-k}) \subset M$. The lower boundary $\partial^- W$ of W is diffeomorphic to the surgered manifold, M' , since $\partial^- H$ is diffeomorphic to $\text{int } D^{k+1} \times S^{n-k-1}$. Explicitly, we can define a diffeomorphism

$$M' \longleftrightarrow \partial^- W$$

$$p \longleftrightarrow \begin{cases} (p, 1) \in (M \setminus \phi(S^k \times 0)) \times -1 & \text{for } p \in M \setminus \phi(S^k \times 0) \\ (u \sinh r, v \cosh r) \in \partial^- H & \text{for } p = (ru, v) \in M', \end{cases}$$

where $(ru, v) \in D^{k+1} \times S^{n-k-1}$ is identified with $\phi(u, rv) \in M$ to form M' , as above. The fact that this is well defined is less obvious than the case for the upper boundary ∂^+W . Consider the following diagram,

$$\begin{array}{ccc}
 M \ni & \phi(u, rv) \longleftrightarrow (ru, v) & \in D^{k+1} \times S^{n-k-1} \\
 & \updownarrow & \updownarrow \\
 M \times -1 \ni & (\phi(u, rv), -1) \leftrightarrow (u \sinh r, v \cosh r) & \in \partial^-H,
 \end{array}$$

where the horizontal arrows represent identifications and the vertical arrows represent diffeomorphisms. In particular, the arrow at the bottom represents the identification in the definition of W , since $(u \sinh r, v \cosh r)$ is the unique point (x, y) satisfying $|x|^2 - |y|^2 = -1$ that lies on the curve $(t^{-1} \cosh r, \sinh r)$, where $t = \frac{\cosh r}{\sinh r}$. Clearly, this diagram commutes, so that the diffeomorphism above is well defined.

Figures 7.2 and 7.3 show the results of this process in the $n = 1, k = 0$ case. In Figure 7.2, we have $M \times [-1, 1]$ on the right, with boundary component $M \times 1$ on the outside and boundary component $M \times -1$ on the inside.

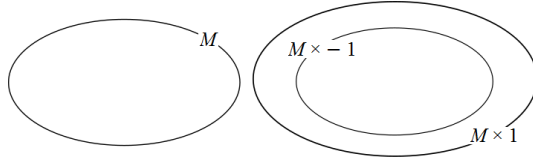

Figure 7.2: The manifolds M and $M \times [-1, 1]$

In Figure 7.3, we have the manifold W , after the handle H has been attached to $M \times [-1, 1]$, with upper boundary $\partial^+W = M$ on the outside, and the lower boundary $\partial^-W = M'$ on the inside.

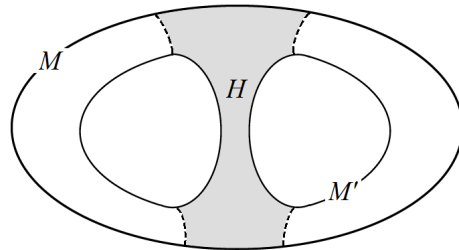

Figure 7.3: The manifold W

7.2 Symplectic cobordism

We can extend this construction to contact manifolds, but first we must define additional properties on the cobordism W defined in Section 7.1.

Definition 7.2.1. A *symplectic manifold* is a smooth manifold equipped with a symplectic differential 2-form ω .

As for symplectic vector spaces, W must have even dimension. We have a volume form ω^n on W , which induces an orientation, and the form ω gives the tangent bundle TW a symplectic structure, and therefore a complex structure, so that symplectic manifolds are almost complex. We define equivalence of symplectic manifolds as follows.

Definition 7.2.2. Let $(W_1, \omega_1), (W_2, \omega_2)$ be symplectic manifolds. A *symplectomorphism* between W_1 and W_2 is a diffeomorphism $f : W_1 \rightarrow W_2$ such that $f^*\omega_2 = \omega_1$.

Definition 7.2.3. Let (W, ω) be a symplectic manifold. A *Liouville vector field* on (W, ω) is a vector field Y satisfying $\mathcal{L}_Y\omega = \omega$, where \mathcal{L} is the Lie derivative.

Proposition 7.2.4. Let (W, ω) be a $(2n)$ -dimensional symplectic manifold with a Liouville vector field Y , and let M be a hypersurface in W , that is, a submanifold of dimension $2n - 1$, equivalently, of codimension 1. Suppose that M is transverse to Y , that is, Y is nowhere tangent to M .

The 1-form $\alpha := i_Y\omega = \omega(Y, -)$ defines a contact form on M .

Proof. By Cartan's formula, we have $\mathcal{L}_Y\omega = d(i_Y\omega) + i_Yd\omega$; since ω is closed, this means that since Y is a Liouville vector field, we have $d(i_Y\omega) = \omega$.

So

$$\begin{aligned} \alpha \wedge (d\alpha)^{n-1} &= i_Y\omega \wedge (d(i_Y\omega))^{n-1} \\ &= i_Y\omega \wedge \omega^{n-1} \\ &= \frac{1}{n}i_Y(\omega^n), \end{aligned}$$

where, to obtain the last line, we have repeatedly used the fact that $i_Y(\omega \wedge \omega) = 2i_Y\omega \wedge \omega$, since ω is a 2-form. Now ω^n is a volume form on W , and M is transverse to Y , so that $\alpha \wedge (d\alpha)^{n-1} = \frac{1}{n}i_Y(\omega^n)$ is a volume form on M , so that α is a contact form on M . \square

Formally, we can define $\alpha = i^*(i_Y\omega)$, where $i : M \rightarrow W$ is inclusion, as the contact form on M .

Proposition 7.2.5. *Let M_1, M_2 be hypersurfaces in the symplectic manifolds $(W_1, \omega_1), (W_2, \omega_2)$, transverse to Liouville vector fields Y_1, Y_2 , and contact forms $\alpha = i_1^*(i_{Y_1}\omega_1), i_2^*(i_{Y_2}\omega_2)$ on M_1, M_2 , where i_1, i_2 are the inclusions $M_1 \rightarrow W_1, M_2 \rightarrow W_2$.*

Let $\phi : M_1 \rightarrow M_2$ be a strict contactomorphism. Extend it to a diffeomorphism $\tilde{\phi}$ of some suitably small cylindrical neighbourhoods of $M_1 \subset W_1, M_2 \subset W_2$ by sending the flow lines of Y_1 to the flow lines of Y_2 . Then $\tilde{\phi}$ is a symplectomorphism.

Proof. First, we have $\tilde{\phi}^*\omega_2$ a symplectic form on the chosen cylindrical neighbourhood of M_1 , since $d(\tilde{\phi}^*\omega_2) = \tilde{\phi}^*d\omega_2 = 0$, and $\tilde{\phi}^*\omega_2$ is nondegenerate since ω_2 is nondegenerate and $\tilde{\phi}$ is a diffeomorphism. We compute, using the definition of $\tilde{\phi}$,

$$i_1^*(i_{Y_1}\tilde{\phi}^*\omega_2) = i_1^*\tilde{\phi}^*(i_{Y_2}\omega_2) = \phi^*i_2^*(i_{Y_2}\omega_2) = \phi^*\alpha_0.$$

Hence we can use $\tilde{\phi}$ to identify the two strict contact manifolds, the two cylindrical neighbourhoods, and the two Liouville vector fields as a single strict contact manifold (M, α) , with a cylindrical neighbourhood with the two symplectic forms ω_1, ω_2 , with a single Liouville vector field Y . It remains to show that $\omega_1 = \omega_2$.

Let $\tilde{\alpha}_j = i_Y\omega_j$. We have $\tilde{\alpha}_j(Y) = \omega_j(Y, Y) = 0$, and so we can compute

$$\mathcal{L}_Y\tilde{\alpha}_j = i_Yd\tilde{\alpha}_j + d(i_Y\tilde{\alpha}_j) = i_Yd(\tilde{\alpha}_j) = i_Yd(i_Y\omega_j) = i_Y\mathcal{L}_Y\omega_j = i_Y\omega_j = \tilde{\alpha}_j.$$

Hence the behaviour of $\tilde{\alpha}_j$ along the flow lines of Y is determined, and so $\tilde{\alpha}_j$ is determined completely by α on M and by Y on the cylindrical neighbourhood of M . So $\tilde{\alpha}_1 = \tilde{\alpha}_2 = \tilde{\alpha}$, and so $\omega_1 = \omega_2 = \omega = d\tilde{\alpha}$ is completely determined by α and Y . This completes the proof. \square

Definition 7.2.6. Let $(M_1, \xi_1), (M_2, \xi_2)$ be contact manifolds, with orientations induced by the contact structures.

A symplectic cobordism is a compact $(2n)$ -dimensional symplectic manifold (W, ω) with orientation induced by the volume form ω^n such that

1. W is a oriented cobordism between M_1, M_2 , that is, with respect to the orientations of the manifolds, $\partial W = M_1 \sqcup \overline{M_2}$.

2. In a neighbourhood of the boundary ∂W , there exists a Liouville vector field Y for ω that is transverse to the boundary and points outward along M_1 , inward along M_2 .
3. The 1-form $\alpha = i_Y\omega$ is a defining contact form for ξ_1, ξ_2 .

The boundary component M_1 is called the ω -convex boundary of the cobordism, and M_2 the ω -concave boundary, or simply the convex and concave boundaries.

Note that symplectic cobordism is not an example of (B, f) -cobordism. However, quaternionic cobordism, which is the quaternionic analogue of complex cobordism, with the cobordism spectrum Ω^{Sp} , is an example of (B, f) -cobordism, which is sometimes referred to as symplectic cobordism, for example in [12]. We also have the related notion of symplectic fillings.

Definition 7.2.7. Let (M, ξ) be a contact manifold. A *strong symplectic filling* of M is a symplectic manifold (W, ω) such that

1. $\partial W = M$.
2. In a neighbourhood of the boundary ∂W , there exists a Liouville vector field Y for ω that points outward along $\partial W = M$, such that $i_Y\omega|_{TM}$ is a contact form for ξ .

We call (M, ξ) the ω -convex boundary of W , or simply the convex boundary.

Since the almost complex structure induced by ω on W is compatible with the almost contact structure induced on M by ξ , we have that the homotopy obstruction to a strong symplectic filling of a contact manifold is an almost complex filling, which is what we want to prove always exists. We also have the notion of weak symplectic cobordisms, and weak symplectic fillings, with the same homotopy obstruction, but we will not be using these directly.

Proposition 7.2.8. *Let M be a closed $(2n - 1)$ -dimensional contact manifold, with contact form α such that $\alpha > 0$ on TM/ξ , and orientation induced by the contact structure. Define the manifold $W = [0, 1] \times M$, with the form $\omega = d(e^t\alpha)$, for $t \in [0, 1]$.*

Then (W, ω) is a symplectic manifold, with Liouville vector field $Y = \partial t$, and is a symplectic cobordism between M and itself.

Proof. By definition, W is a trivial oriented cobordism between M and itself.

Since α is a 1-form and e^t is a smooth function, $d(e^t\alpha)$ is a 2-form; since it is exact, it is closed. We compute

$$\begin{aligned}\omega^n &= (d(e^t\alpha))^n \\ &= (e^t dt \wedge \alpha + e^t d\alpha)^n \\ &= e^{nt} dt \wedge \alpha \wedge (d\alpha)^{n-1},\end{aligned}$$

since $\alpha \wedge \alpha = 0$, and $(d\alpha)^n = 0$, so all other terms vanish. Since $\alpha \wedge (d\alpha)^{n-1}$ is a volume form on M , and $e^{nt} dt$ is a volume form on $[0, 1]$, this is a volume form on $W = [0, 1] \times M$, so that ω is nondegenerate, and so is a symplectic form.

We now check the Liouville condition on ∂t , that is, $\mathcal{L}_{\partial t}\omega = \omega$. Using Cartan's formula, and the fact that ω is closed, we have

$$\begin{aligned}\mathcal{L}_{\partial t}\omega &= d(i_{\partial t}\omega) \\ &= d(i_{\partial t}(e^t dt \wedge \alpha + e^t d\alpha)) \\ &= d(e^t(dt \wedge \alpha)(\partial t, -) + e^t d\alpha(\partial t, -)) \\ &= d(e^t\alpha) \\ &= \omega,\end{aligned}$$

since $\alpha(\partial t) = 0$, $d\alpha(\partial t, -) = 0$. So the Liouville condition is satisfied. Since ∂t points in the direction of positive t , this means that it points outwards at the $1 \times M$ boundary, and inwards at the $0 \times M$ boundary.

Now define the 1-form $\eta = i_{\partial t}\omega$. We have $\eta = e^t\alpha$, as above, and this restricts to the forms $e\alpha, \alpha$, which are contact forms for (M, ξ) compatible with the orientations.

This is called the *trivial symplectic cobordism*. □

Note that the volume form $e^t dt \wedge \alpha \wedge (d\alpha)^{n-1}$ induces the same orientation as the one induced by the product $[0, 1] \times M$, which is why we have taken the product in that order. Figure 7.4 shows the trivial symplectic cobordism $[0, 1] \times M$ for a 1-dimensional manifold M , together with some of the flow lines of its Liouville vector field.

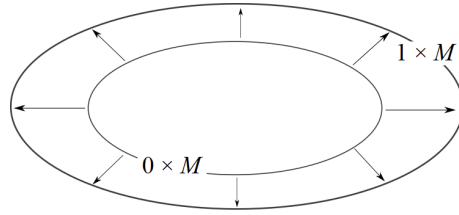

Figure 7.4: The trivial symplectic cobordism $[0, 1] \times M$

7.3 Contact surgery

When we were performing surgery along a sphere $S^k \subset M$ with trivial normal bundle, we were able to attach a handle H smoothly to the manifold $W = M \times [0, 1]$ by identifying a neighbourhood of $S^k M \subset \partial W$ diffeomorphic to a neighbourhood of $\partial^+ H \subset \partial H$. We want to be able to perform surgery on a contact manifold, such that the surgered manifold also has a contact structure, that coincides with the original contact structure outside the surgered neighbourhood.

We describe the process of contact surgery, following Weinstein in [14]. The handle we attach is a symplectic handle, often referred to as a Weinstein handle, which we can use in a similar way to the topological case, except that we identify neighbourhoods via a symplectomorphism, rather than a diffeomorphism. We need some definitions before we state a theorem about neighbourhoods in contact manifolds that will allow us to do this.

Definition 7.3.1. Let M be a contact manifold with contact form α compatible with the orientation induced by the contact structure. Let $L \subset M$ an isotropic submanifold, so that $TL \subset (TL)^\alpha$, where $(TL)^\alpha$ is the symplectic complement of TL . The *symplectic normal bundle* of L in M is $SN_M(L) = (TL)^\alpha / TL$.

This is well defined, since the contact form α is unique up to multiplication by a positive function. Since M is isotropic, we can split the normal bundle of L in M as

$$N_M L = (TM|_L) / (TL) = (TM|_L) / (\xi|_L) \oplus (\xi_L) / (TL)^\alpha \oplus (TL)^\alpha / (TL).$$

The first summand is the normal component of L not in ξ , which is a trivial line bundle. The third is the symplectic normal bundle. For the second

summand, define the map

$$\begin{aligned} (\xi_L)/(TL)^{d\alpha} &\mapsto T^*L \\ [Y] &\mapsto d\alpha(Y, -)|_{TL} = i_Y d\alpha|_{TL}. \end{aligned}$$

By definition of symplectic complements, this vector bundle homomorphism is well defined and injective. Let M have dimension $2n - 1$, L have dimension $k - 1$, where $k \leq n$ since L is isotropic. The bundle $(TL)^{d\alpha}$ has rank $(2n - 2) - (k - 1)$, by Proposition 2.2.5, so $(\xi_L)/(TL)^{d\alpha}$ has rank $(k - 1)$, which is the rank of T^*L , so the map is actually an isomorphism.

Theorem 7.3.2. *Let $(M_1, \alpha_1), (M_2, \alpha_2)$ be strict contact manifolds, with closed isotropic submanifolds L_1, L_2 . Suppose there exists a smooth isomorphism $(\Phi : SN_{M_1}(L_1) \rightarrow SN_{M_2}(L_2), \phi : L_1 \rightarrow L_2)$ of symplectic normal bundles. Then the diffeomorphism ϕ extends to a strict contactomorphism $\psi : \mathcal{N}(L_1) \rightarrow \mathcal{N}(L_2)$ for some neighbourhoods $\mathcal{N}(L_1), \mathcal{N}(L_2)$ of L_1, L_2 , such that $T\psi|_{SN_{M_1}(L_1)} = \Phi$.*

Proof. This theorem is proven in Section 4 of [14], and in Theorems 2.5.8 and 6.2.2 of [4]. \square

Let M be a $(2n - 1)$ -dimensional contact manifold, $S^{k-1} \in M$ isotropic, so that $0 \leq k \leq n$, with trivial symplectic normal bundle. We know that the normal bundle of S^{k-1} in M is

$$\begin{aligned} &(TM|_{S^{k-1}})/(TS^{k-1}) \\ &= (TM|_{S^{k-1}})/(\xi|_{S^{k-1}}) \oplus (\xi_{S^{k-1}})/(TS^{k-1})^{d\alpha} \oplus (TS^{k-1})^{d\alpha}/(TS^{k-1}) \\ &\cong \underline{\mathbb{R}} \oplus T^*S^{k-1} \oplus SN_M(S^{k-1}). \end{aligned}$$

We claim that $\underline{\mathbb{R}} \oplus T^*S^{k-1}$ is trivial. Take the usual embedding of S^{k-1} in \mathbb{R}^k . The normal bundle of this embedding is a trivial line bundle, and its sum with the tangent bundle TS^{k-1} is the tangent bundle of \mathbb{R}^k restricted to S^{k-1} , which is trivial. Hence TS^{k-1} plus a trivial line bundle is trivial. Taking duals, we have $\underline{\mathbb{R}} \oplus T^*S^{k-1}$ trivial, as required. Using the fact that S^{k-1} has trivial symplectic normal bundle, we deduce that the normal bundle of S^{k-1} in M is trivial, so we can perform a smooth surgery along S^{k-1} .

Let $W = [-1, 1] \times M$ be the trivial symplectic cobordism from M to itself. We now define the symplectic model handle that we can attach at S^{k-1} . Let \mathbb{R}^{2n} be equipped with the standard symplectic form ω_0 . Explicitly, let

$(p_1, \dots, p_k, p_n, q_1, \dots, q_n)$ be the co-ordinates of \mathbb{R}^{2n} , then $\omega_0 = \sum_{j=1}^n dp_j \wedge dq_j$. For simplicity of notation, let $p = (p_1, \dots, p_n), q = (q_1, \dots, q_n)$. Define the vector field

$$Y = \sum_{j=1}^k (2p_j \partial p_j - q_j \partial q_j) + \frac{1}{2} \sum_{j=k+1}^n (p_j \partial p_j + q_j \partial q_j).$$

We compute

$$\begin{aligned} \mathcal{L}_Y \omega_0 &= d(i_Y \omega_0) \\ &= d\omega_0(Y, -) \\ &= d\left(\sum_{j=1}^k (q_j dp_j + 2p_j dq_j) + \frac{1}{2} \sum_{j=k+1}^n (-q_j dp_j + p_j dq_j)\right) \\ &= \sum_{j=1}^k (dq_j \wedge dp_j + 2dp_j \wedge dq_j) + \frac{1}{2} \sum_{j=k+1}^n (-dq_j \wedge dp_j + dp_j \wedge dq_j) \\ &= \sum_{j=1}^k (-dp_j \wedge dq_j + 2dp_j \wedge dq_j) + \frac{1}{2} \sum_{j=k+1}^n (dp_j \wedge dq_j + dp_j \wedge dq_j) \\ &= \sum_{j=1}^n dp_j \wedge dq_j \\ &= \omega_0, \end{aligned}$$

so that Y is a Liouville vector field. Now $Y = df$, where

$$\begin{aligned} f : \mathbb{R}^{2n} &\rightarrow \mathbb{R}^{2n} \\ (p, q) &\mapsto \sum_{j=1}^k \left(p_j^2 - \frac{1}{2}q_j^2\right) + \frac{1}{4} \sum_{j=k+1}^n (p_j^2 + q_j^2), \end{aligned}$$

so that Y is transverse to the level sets of f . Define the $(k-1)$ -sphere,

$$S_H^{k-1} = \{(p, q) : \sum_{j=1}^k p_j^2 = 1, p_{k+1} = \dots = p_n = q_1 = \dots = 0\} \subset f^{-1}(1),$$

and let \mathcal{N}_H be an open neighbourhood of S_H^{k-1} in $f^{-1}(1)$, which is a hypersurface, so that \mathcal{N}_H is diffeomorphic to $S^{k-1} \times \text{int } D^{2n-k}$.

Define the *symplectic handle* H as the set of points in $f^{-1}[-1, 1]$ that lie on gradient flow lines of f through \mathcal{N}_H . In a similar way to the topological case, H is diffeomorphic to $D^k \times D^{2n-k}$. We have the upper boundary $\partial^- H = \{(p, q) \in H : f(p, q) = 1\}$ and the lower boundary $\partial^+ H = \{(p, q) \in H : f(p, q) = -1\}$. In particular, note that the upper boundary is precisely \mathcal{N}_H . We also have the core $D^k \times 0$, the cocore or belt disc $0 \times D^{2n-k}$, and the belt sphere $0 \times \partial D^{2n-1} \cong S^{2n-k-1}$. As in the topological case, we call k the index of the handle, and refer to H as a symplectic k -handle.

Figure 7.5 shows the symplectic handle H , shaded, for the case $n = 1, k = 1$, with some of the flow lines of the Liouville vector field on $(\mathbb{R}^2, \omega) \supset H$. The upper boundary $\partial^+ H = \mathcal{N}_H$ consists of the two curves bounding H from the top and bottom; the lower boundary $\partial^- H$ consists of the two curves bounding H from the left and right. Since $\mathcal{N}_H \cong S^0 \times \text{int } D^1$, the corners are not included, as in the topological case.

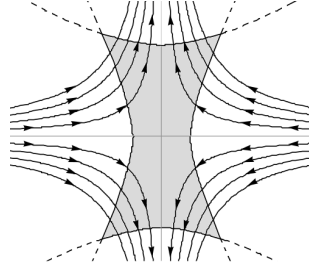

Figure 7.5: The symplectic handle H

Since the Liouville vector field $Y = df$, Y is transverse to the level sets of f . In particular, Y is transverse to the lower and upper boundaries of H , and so induces a contact form

$$\alpha_0 = i_Y \omega_0 = \sum_{j=1}^k (q_j dp_j + 2p_j dq_j) + \frac{1}{2} \sum_{j=k+1}^n (-q_j dp_j + p_j dq_j)$$

on the boundaries $\partial^\pm H$, by Proposition 7.2.4.

Consider the sphere $S_H^{k-1} \subset \mathcal{N}_H = \partial^+ H$. The tangent space to the sphere at $p' = \{(p_1, \dots, p_k, 0, \dots, 0)\}$ is the hyperplane in \mathbb{R}^k orthogonal to p' , so for

any $(x) \in T_{p'}S_H^{k-1}$, we have

$$\begin{aligned} \alpha_0(x) &= \sum_{j=1}^k (q_j|_{p'} dp_j(x) + 2p_j|_{p'} dq_j(x)) \\ &\quad + \frac{1}{2} \sum_{j=k+1}^n (-q_j|_{p'} dp_j(x) + p_j|_{p'} dq_j(x)) = 0, \end{aligned}$$

since $q_j|_{p'} = 0$ for all j , by definition, and $dq_j(x) = 0$ for all j , since $S_H^{k-1} \subset \mathbb{R}^k \times (0, \dots, 0) \subset \mathbb{R}^{2n}$, so ∂q_j is always normal to S_H^{k-1} . Hence $\alpha_0 = 0$ on the tangent bundle of S_H^{k-1} , so S_H^{k-1} is an isotropic submanifold of $\partial^+ H = \mathcal{N}_H$.

We want to compute the symplectic normal bundle of S_H^{k-1} in \mathcal{N}_H . The vector fields tangent to \mathcal{N}_H are the vector fields in TS_H^{k-1} , as well as ∂p_j for $j > k$, and all the ∂q_j . Since S_H^{k-1} is contained within \mathbb{R}^k , with the first k coordinates of \mathbb{R}^{2n} , we have $d\alpha_0(X, p_j) = \omega_0(X, \partial p_j) = 0$, and $d\alpha_0(X, \partial q_j) = 0$, for $j = k+1, \dots, n$, for every $X \in TS_H^{k-1}$, so $\text{span}\{\partial p_j, \partial q_j\}_{k+1 \leq j \leq n} \subset (TS_H^{k-1})^{d\alpha_0}$. However, ∂q_j , for $j \leq k$, are not in $(TS_H^{k-1})^{d\alpha_0}$, since $TS_H^{k-1} \subset \text{span}\{\partial p_j\}_{j \leq k}$. This gives us

$$(TS_H^{k-1})^{d\alpha} = TS_H^{k-1} \oplus \text{span}\{\partial p_j, \partial q_j\}_{k+1 \leq j \leq n},$$

so that

$$SN_{\mathcal{N}_H} S_H^{k-1} = \text{span}\{\partial p_j, \partial q_j\}_{k+1 \leq j \leq n} = T\mathbb{R}^{2n-2k}$$

is trivial.

We can now apply Theorem 7.3.2 to $S^{k-1} \subset M, S^{k-1} \subset \mathcal{N}_H \subset H$, since they are diffeomorphic, and both have trivial symplectic normal bundle, so that the diffeomorphism defines a bundle isomorphism of trivial symplectic normal bundles. Hence $S^{k-1} \subset M$ and $S^{k-1} \subset \mathcal{N}_H$ are equivalent via a strict contactomorphism. Finally, by Proposition 7.2.5, we can identify a neighbourhood of $S^{k-1} \subset M, S^{k-1} \subset \mathcal{N}_H \subset H$ via a symplectomorphism, and so smoothly attach the symplectic model handle to $W = [-1, 1] \times M$, using the Liouville vector fields on those neighbourhoods to smoothly join the symplectic forms. The boundary of W is now $M \sqcup M'$, where M' is the surgered manifold. As in the topological case, M agrees with M' , as strict contact manifolds, outside the neighbourhood where the surgery is performed. This process is called *contact surgery*.

Figure 7.6 shows the process of attaching a handle for the case $n = 1, k = 1$. As in the topological case, the outer boundary component is the original

manifold M , and the inner boundary component is the surgered manifold M' .

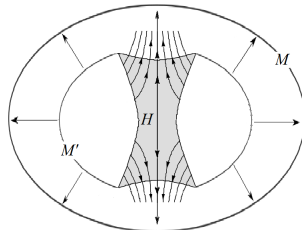

Figure 7.6: Attaching a symplectic handle

7.4 Applying contact surgery

Recall from the end of Chapter 6 that if we have a $(2n - 1)$ -dimensional contact manifold (M, ξ) , then there exists an almost complex manifold W that is a filling of an almost contact structure on M , which is homotopic to the original almost contact structure on (M, ξ) outside the interior $\text{int } D^{2n-1}$ of some disc D^{2n-1} . In addition, the almost contact structures are stably equivalent, as they are both compatible with the stably complex filling found in Chapter 5. We want to change the almost contact structure on the interior of this disc so that it is homotopic to the original, while preserving the almost complex filling, to obtain an almost complex filling of (M, ξ) . To do this, we will take the connected sum of M with S^{2n-1} , attaching the sphere, with a suitable almost contact structure, in this neighbourhood. Note that the new manifold will be diffeomorphic to M .

We can choose an embedding of D^{2n-1} in the standard sphere S^{2n-1} , so we have an embedding of $S^0 \times D^{2n-1}$ in the disjoint union $M \sqcup S^{2n-1}$. The symplectic normal bundle of S^0 has rank 0 and is therefore trivial, so, with a choice of contact structure on S^{2n-1} , we can perform a contact surgery along $S^0 \in M \sqcup S^{2n-1}$. This is equivalent to taking the connected sum of M and some contact sphere S^{2n-1} .

We will use a slightly different setup from the one above. We choose D^{2n-1} sufficiently small such that we can define a contact structure compatible with the almost contact structure on D^{2n-1} . We take S^{2n-1} with a contact form, and a strong symplectic filling X . We take a collar neighbourhood $(-\varepsilon, 0] \times D^{2n-1} \subset W$ of the small contact disc D^{2n-1} in W , and define

the symplectic form as for the trivial cobordism on this collar neighbourhood. This symplectic form determines an almost complex structure up to homotopy, which induces the given contact structure on $D^{2n-1} \subset M$ up to homotopy. We define a similar collar neighbourhood of $D^{2n-1} \subset S^{2n-1}$ in X , with the symplectic form of X ; since X is a strong symplectic filling of S^{2n-1} , the almost complex structure on X induces the given almost contact structure on $\partial X = S^{2n-1}$ up to homotopy. We can now attach a symplectic 1-handle, via a symplectomorphism obtained using the flow lines of Liouville vector fields, to $W \sqcup X$ at $x_0 \times D^{2n-1} \subset M$, and at $x_1 \times D^{2n-1} \subset S^{2n-1}$, as in Section 7.3.

The surgered manifold M' is the connected sum of M and S^{2n-1} , which is diffeomorphic to M , and their almost contact structures are homotopic outside the interior of D^{2n-1} . The symplectomorphisms used in attaching the handle also allows us to join the almost complex structures smoothly up to homotopy, since the set of almost complex structures compatible with a given symplectic form, $Sp(2n, \mathbb{R})/U(n)$, is contractible. Hence attaching the handle defines an almost complex filling W' up to homotopy. It remains to show that there is a choice of contact structure on S^{2n-1} , with a strong symplectic filling X , such that the almost contact structure on S^{2n-1} is homotopic to the original almost contact structure on $D^{2n-1} \subset (M, \xi)$.

From the results in Section 5 of [3], and Theorem 2 of [1], there exists a contact structure in every homotopy class of almost contact structures on S^{2n-1} , for $2n - 1 \equiv 1, 3, 5 \pmod{8}$, and every stably trivial homotopy class of almost contact structures for $2n - 1 \equiv 7 \pmod{8}$, which admit strong symplectic fillings. The trivial homotopy class of almost contact structures is the homotopy class of the standard contact structure on S^{2n-1} . For $2n - 1 \equiv 1, 3, 5 \pmod{8}$, it is immediate that we can define a contact structure on S^{2n-1} so that the induced almost contact structure is homotopic to the original almost contact structure on (M, ξ) , so the surgered manifold has the same almost contact structure as (M, ξ) , and admits an almost complex filling. For $2n - 1 \equiv 7 \pmod{8}$, we choose the embedded disc $D^{2n-1} \subset M$ so that we can assume the contact structure on its interior is the same as the standard contact structure on S^{2n-1} . Since the original almost contact structure on M is stably equivalent to the almost contact structure on $\text{int } D^{2n-1}$, the fact that we can construct contact structures in every homotopy class that is stably equivalent to this one is sufficient for us to define the desired contact structure on S^{2n-1} . Hence, in all cases, M , with the almost contact structure induced by its contact structure, admits an almost complex filling.

Bibliography

- [1] F. Ding and H. Geiges. E_8 -plumbings and exotic contact structures on spheres. *International Mathematics Research Notices*, 2004(71):3825–3837, 2004.
- [2] Y. Eliashberg and N. Mishachev. *Introduction to the h-Principle*, volume 48 of *Graduate Studies in Mathematics*. American Mathematical Society, 2002.
- [3] H. Geiges. Applications of contact surgery. *Topology*, 36(6):1193–1220, 1997.
- [4] H. Geiges. *An Introduction to Contact Topology*, volume 109 of *Cambridge studies in advance mathematics*. Cambridge University Press, 2008.
- [5] A. Hatcher. *Algebraic Topology*. Cambridge University Press, 2001.
- [6] W. M. Hirsch. Immersions of manifolds. *Transactions of the American Mathematical Society*, 93(2):242–276, 1959.
- [7] P. Kirk and J. F. Davis. *Lecture notes in algebraic topology*, volume 35 of *Graduate Studies in Mathematics*. American Mathematical Society, 2001.
- [8] J. W. Milnor. Construction of universal bundles II. *Annals of Mathematics*, 63(3):430–436, 1956.
- [9] J. W. Milnor. On the cobordism ring and a complex analogue, part I. *American Journal of Mathematics*, 82(3):505–521, 1960.

- [10] J. W. Milnor. A procedure for killing homotopy groups of differential manifolds. In *Proceedings of Symposia in Pure Mathematics*, volume 3, pages 39–55. American Mathematical Society, 1961.
- [11] N. E. Steenrod. *The Topology of Fibre Bundles*. Princeton University Press, 1951.
- [12] R. E. Stong. *Notes on cobordism theory*. Princeton Landmarks in Mathematics. Princeton University Press, 1968.
- [13] A. Van de Van. On the chern numbers of certain complex and almost complex manifolds. *Proceedings of the National Academy of Sciences of the United States of America*, 55(6):1624–1627, 1966.
- [14] A. Weinstein. Contact surgery and symplectic handlebodies. *Hokkaido Mathematical Journal*, 20(2):241–251, 1991.